

 WILEY

SEVENTH EDITION

# CHEMICAL THERMODYNAMICS

BASIC CONCEPTS AND METHODS

IRVING M. KLOTZ  
ROBERT M. ROSENBERG

CARNOT    HELMHOLTZ    **KELVIN**    DUHEM  
*Gibbs*    Clausius  
Lewis    Joule    PLANCK

---

# CHEMICAL THERMODYNAMICS

## Basic Concepts and Methods

---

Seventh Edition

**IRVING M. KLOTZ**

Late Morrison Professor Emeritus, Northwestern University

**ROBERT M. ROSENBERG**

MacMillen Professor Emeritus, Lawrence University, Adjunct Professor,  
Northwestern University



A JOHN WILEY & SONS, INC., PUBLICATION



# CHEMICAL THERMODYNAMICS



---

# CHEMICAL THERMODYNAMICS

## Basic Concepts and Methods

---

Seventh Edition

**IRVING M. KLOTZ**

Late Morrison Professor Emeritus, Northwestern University

**ROBERT M. ROSENBERG**

MacMillen Professor Emeritus, Lawrence University, Adjunct Professor,  
Northwestern University



A JOHN WILEY & SONS, INC., PUBLICATION

Copyright © 2008 by John Wiley & Sons, Inc. All rights reserved

Published by John Wiley & Sons, Inc., Hoboken, New Jersey  
Published simultaneously in Canada

No part of this publication may be reproduced, stored in a retrieval system, or transmitted in any form or by any means, electronic, mechanical, photocopying, recording, scanning, or otherwise, except as permitted under Section 107 or 108 of the 1976 United States Copyright Act, without either the prior written permission of the Publisher, or authorization through payment of the appropriate per-copy fee to the Copyright Clearance Center, Inc., 222 Rosewood Drive, Danvers, MA 01923, (978) 750-8400, fax (978) 750-4470, or on the web at [www.copyright.com](http://www.copyright.com). Requests to the Publisher for permission should be addressed to the Permissions Department, John Wiley & Sons, Inc., 111 River Street, Hoboken, NJ 07030, (201) 748-6011, fax (201) 748-6008, or online at <http://www.wiley.com/go/permission>.

**Limit of Liability/Disclaimer of Warranty:** While the publisher and author have used their best efforts in preparing this book, they make no representations or warranties with respect to the accuracy or completeness of the contents of this book and specifically disclaim any implied warranties of merchantability or fitness for a particular purpose. No warranty may be created or extended by sales representatives or written sales materials. The advice and strategies contained herein may not be suitable for your situation. You should consult with a professional where appropriate. Neither the publisher nor author shall be liable for any loss of profit or any other commercial damages, including but not limited to special, incidental, consequential, or other damages.

For general information on our other products and services or for technical support, please contact our Customer Care Department within the United States at (800) 762-2974, outside the United States at (317) 572-3993 or fax (317) 572-4002.

Wiley also publishes its books in a variety of electronic formats. Some content that appears in print may not be available in electronic formats. For more information about Wiley products, visit our web site at [www.wiley.com](http://www.wiley.com).

*Library of Congress Cataloging-in-Publication Data is available.*

ISBN: 978-0-471-78015-1

Printed in the United States of America

10 9 8 7 6 5 4 3 2 1

Dedicated to the Memory of  
Irving Myron Klotz  
January 22, 1916–April 27, 2005  
Distinguished scientist, master teacher, dedicated mentor, and colleague





# CONTENTS

---

<b>PREFACE</b>	<b>xix</b>
<b>1 INTRODUCTION</b>	<b>1</b>
1.1 Origins of Chemical Thermodynamics / 1	
1.2 Objectives of Chemical Thermodynamics / 4	
1.3 Limitations of Classic Thermodynamics / 4	
References / 6	
<b>2 MATHEMATICAL PREPARATION FOR THERMODYNAMICS</b>	<b>9</b>
2.1 Variables of Thermodynamics / 10	
Extensive and Intensive Quantities / 10	
Units and Conversion Factors / 10	
2.2 Analytic Methods / 10	
Partial Differentiation / 10	
Exact Differentials / 15	
Homogeneous Functions / 18	
Exercises / 21	
References / 27	
<b>3 THE FIRST LAW OF THERMODYNAMICS</b>	<b>29</b>
3.1 Definitions / 29	
Temperature / 31	
Work / 33	

- 3.2 The First Law of Thermodynamics / 37  
     Energy / 37  
     Heat / 38  
     General Form of the First Law / 38  
 Exercises / 40  
 References / 41

## 4 ENTHALPY, ENTHALPY OF REACTION, AND HEAT CAPACITY

43

- 4.1 Enthalpy / 44  
     Definition / 44  
     Relationship between  $Q_V$  and  $Q_P$  / 46  
 4.2 Enthalpy of Reactions / 47  
     Definitions and Conventions / 47  
 4.3 Enthalpy as a State Function / 52  
     Enthalpy of Formation from Enthalpy of Reaction / 52  
     Enthalpy of Formation from Enthalpy of Combustion / 53  
     Enthalpy of Transition from Enthalpy of Combustion / 53  
     Enthalpy of Conformational Transition of a Protein from Indirect Calorimetric Measurements / 54  
     Enthalpy of Solid-State Reaction from Measurements of Enthalpy of Solution / 56  
 4.4 Bond Enthalpies / 57  
     Definition of Bond Enthalpies / 57  
     Calculation of Bond Enthalpies / 58  
     Enthalpy of Reaction from Bond Enthalpies / 59  
 4.5 Heat Capacity / 60  
     Definition / 61  
     Some Relationships between  $C_P$  and  $C_V$  / 62  
     Heat Capacities of Gases / 64  
     Heat Capacities of Solids / 67  
     Heat Capacities of Liquids / 68  
     Other Sources of Heat Capacity Data / 68  
 4.6 Enthalpy of Reaction as a Function of Temperature / 68  
     Analytic Method / 69  
     Arithmetic Method / 71  
     Graphical or Numerical Methods / 72  
 Exercises / 72  
 References / 78

## 5 APPLICATIONS OF THE FIRST LAW TO GASES

81

- 5.1 Ideal Gases / 81  
     Definition / 81

- Enthalpy as a Function of Temperature Only / 83
- Relationship Between  $C_p$  and  $C_v$  / 84
- Calculation of the Thermodynamic Changes in  
Expansion Processes / 84
- 5.2 Real Gases / 94
  - Equations of State / 94
  - Joule–Thomson Effect / 98
  - Calculations of Thermodynamic Quantities in Reversible  
Expansions / 102
- Exercises / 104
- References / 108

## 6 THE SECOND LAW OF THERMODYNAMICS

111

- 6.1 The Need for a Second Law / 111
- 6.2 The Nature of the Second Law / 112
  - Natural Tendencies Toward Equilibrium / 112
  - Statement of the Second Law / 112
  - Mathematical Counterpart of the Verbal Statement / 113
- 6.3 The Carnot Cycle / 113
  - The Forward Cycle / 114
  - The Reverse Cycle / 116
  - Alternative Statement of the Second Law / 117
  - Carnot's Theorem / 118
- 6.4 The Thermodynamic Temperature Scale / 120
- 6.5 The Definition of  $S$ , the Entropy of a System / 125
- 6.6 The Proof that  $S$  is a Thermodynamic Property / 126
  - Any Substance in a Carnot Cycle / 126
  - Any Substance in Any Reversible Cycle / 127
  - Entropy  $S$  Depends Only on the State  
of the System / 129
- 6.7 Entropy Changes in Reversible Processes / 130
  - General Statement / 130
  - Isothermal Reversible Changes / 130
  - Adiabatic Reversible Changes / 131
  - Reversible Phase Transitions / 131
  - Isobaric Reversible Temperature Changes / 132
  - Isochoric Reversible Temperature Changes / 133
- 6.8 Entropy Changes in Irreversible Processes / 133
  - Irreversible Isothermal Expansion of an Ideal Gas / 133
  - Irreversible Adiabatic Expansion of an Ideal Gas / 135
  - Irreversible Flow of Heat from a Higher Temperature  
to a Lower Temperature / 136

Irreversible Phase Transitions / 137  
Irreversible Chemical Reactions / 138  
General Statement / 139

6.9 General Equations for the Entropy of Gases / 142  
    Entropy of the Ideal Gas / 142  
    Entropy of a Real Gas / 143

6.10 Temperature–Entropy Diagram / 144

6.11 Entropy as an Index of Exhaustion / 146

Exercises / 150  
References / 157

## 7 EQUILIBRIUM AND SPONTANEITY FOR SYSTEMS AT CONSTANT TEMPERATURE

159

7.1 Reversibility, Spontaneity, and Equilibrium / 159  
    Systems at Constant Temperature and Volume / 160  
    Systems at Constant Temperature and Pressure / 162  
    Heat of Reaction as an Approximate  
    Criterion of Spontaneity / 164

7.2 Properties of the Gibbs, Helmholtz, and Planck Functions / 165  
    The Functions as Thermodynamic Properties / 165  
    Relationships among  $G$ ,  $Y$ , and  $A$  / 165  
    Changes in the Functions for Isothermal Conditions / 165  
    Equations for Total Differentials / 166  
    Pressure and Temperature Derivatives of the  
    Functions / 167  
    Equations Derived from the Reciprocity  
    Relationship / 169

7.3 The Gibbs Function and Chemical Reactions / 170  
    Standard States / 170

7.4 Pressure and Temperature Dependence of  $\Delta G$  / 172

7.5 Useful Work and the Gibbs and Helmholtz Functions / 175  
    Isothermal Changes / 175  
    Changes at Constant Temperature and Pressure / 177  
    Relationship between  $\Delta H_P$  and  $Q_P$  When Useful Work is  
    Performed / 178  
    Application to Electrical Work / 179  
    Gibbs–Helmholtz Equation / 180  
    The Gibbs Function and Useful Work in  
    Biologic Systems / 181

Exercises / 185  
References / 191

## **8 APPLICATION OF THE GIBBS FUNCTION AND THE PLANCK FUNCTION TO SOME PHASE CHANGES** **193**

- 8.1 Two Phases at Equilibrium as a Function of Pressure and Temperature / 193
  - Clapeyron Equation / 194
  - Clausius–Clapeyron Equation / 196
- 8.2 The Effect of an Inert Gas on Vapor Pressure / 198
  - Variable Total Pressure at Constant Temperature / 199
  - Variable Temperature at Constant Total Pressure / 200
- 8.3 Temperature Dependence of Enthalpy of Phase Transition / 200
- 8.4 Calculation of Change in the Gibbs Function for Spontaneous Phase Change / 202
  - Arithmetic Method / 202
  - Analytic Method / 203
- Exercises / 205
- References / 210

## **9 THERMODYNAMICS OF SYSTEMS OF VARIABLE COMPOSITION** **211**

- 9.1 State Functions for Systems of Variable Composition / 211
- 9.2 Criteria of Equilibrium and Spontaneity in Systems of Variable Composition / 213
- 9.3 Relationships Among Partial Molar Properties of a Single Component / 215
- 9.4 Relationships Between Partial Molar Quantities of Different Components / 216
  - Partial Molar Quantities for Pure Phase / 218
- 9.5 Escaping Tendency / 219
  - Chemical Potential and Escaping Tendency / 219
- 9.6 Chemical Equilibrium in Systems of Variable Composition / 221
- Exercises / 223
- Reference / 226

## **10 MIXTURES OF GASES AND EQUILIBRIUM IN GASEOUS MIXTURES** **227**

- 10.1 Mixtures of Ideal Gases / 227
  - The Entropy and Gibbs Function for Mixing Ideal Gases / 228
  - The Chemical Potential of a Component of an Ideal Gas Mixture / 230

- Chemical Equilibrium in Ideal Gas Mixtures / 231
- Dependence of  $K$  on Temperature / 232
- Comparison of Temperature Dependence of  $\Delta G_m^\circ$  and  $\ln K$  / 234
- 10.2 The Fugacity Function of a Pure Real Gas / 236
  - Change of Fugacity with Pressure / 237
  - Change of Fugacity with Temperature / 238
- 10.3 Calculation of the Fugacity of a Real Gas / 239
  - Graphical or Numerical Methods / 240
  - Analytical Methods / 244
- 10.4 Joule–Thomson Effect for a Van der Waals Gas / 247
  - Approximate Value of  $\alpha$  for a Van der Waals Gas / 247
  - Fugacity at Low Pressures / 248
  - Enthalpy of a Van der Waals Gas / 248
  - Joule–Thomson Coefficient / 249
- 10.5 Mixtures of Real Gases / 249
  - Fugacity of a Component of a Gaseous Solution / 250
  - Approximate Rule for Solutions of Real Gases / 251
  - Fugacity Coefficients in Gaseous Solutions / 251
  - Equilibrium Constant and Change in Gibbs Functions and Planck Functions for Reactions of Real Gases / 252
- Exercises / 253
- References / 256

## 11 THE THIRD LAW OF THERMODYNAMICS

259

- 11.1 Need for the Third Law / 259
- 11.2 Formulation of the Third Law / 260
  - Nernst Heat Theorem / 260
  - Planck's Formulation / 261
  - Statement of Lewis and Randall / 262
- 11.3 Thermodynamic Properties at Absolute Zero / 263
  - Equivalence of  $G$  and  $H$  / 263
  - $\Delta C_p$  in an Isothermal Chemical Reaction / 263
  - Limiting Values of  $C_p$  and  $C_v$  / 264
  - Temperature Derivatives of Pressure and Volume / 264
- 11.4 Entropies at 298 K / 265
  - Typical Calculations / 266
  - Apparent Exceptions to the Third Law / 270
  - Tabulations of Entropy Values / 274
- Exercises / 277
- References / 280

<b>12 APPLICATION OF THE GIBBS FUNCTION TO CHEMICAL CHANGES</b>	<b>281</b>
12.1 Determination of $\Delta G_m^\circ$ from Equilibrium Measurements /	281
12.2 Determination of $\Delta G_m^\circ$ from Measurements of Cell potentials /	284
12.3 Calculation of $\Delta G_m^\circ$ from Calorimetric Measurements /	285
12.4 Calculation of a Gibbs Function of a Reaction from Standard Gibbs Function of Formation /	286
12.5 Calculation of a Standard Gibbs Function from Standard Entropies and Standard Enthalpies /	287
Enthalpy Calculations /	287
Entropy Calculations /	290
Change in Standard Gibbs Function /	290
Exercises /	293
References /	301
<b>13 THE PHASE RULE</b>	<b>303</b>
13.1 Derivation of the Phase Rule /	303
Nonreacting Systems /	304
Reacting Systems /	306
13.2 One-Component Systems /	307
13.3 Two-Component Systems /	309
Two Phases at Different Pressures /	312
Phase Rule Criterion of Purity /	315
Exercises /	316
References /	316
<b>14 THE IDEAL SOLUTION</b>	<b>319</b>
14.1 Definition /	319
14.2 Some Consequences of the Definition /	321
Volume Changes /	321
Heat Effects /	322
14.3 Thermodynamics of Transfer of a Component from One Ideal Solution to Another /	323
14.4 Thermodynamics of Mixing /	325
14.5 Equilibrium between a Pure Solid and an Ideal Liquid Solution /	327
Change of Solubility with Pressure at a Fixed Temperature /	328
Change of Solubility with Temperature /	329



14.6	Equilibrium between an Ideal Solid Solution and an Ideal Liquid Solution / 332	
	Composition of the Two Phases in Equilibrium / 332	
	Temperature Dependence of the Equilibrium Compositions / 333	
	Exercises / 333	
	References / 335	
<b>15</b>	<b>DILUTE SOLUTIONS OF NONELECTROLYTES</b>	<b>337</b>
15.1	Henry's Law / 337	
15.2	Nernst's Distribution Law / 340	
15.3	Raoult's Law / 341	
15.4	Van't Hoff's Law of Osmotic Pressure / 344	
	Osmotic Work in Biological Systems / 349	
15.5	Van't Hoff's Law of Freezing-Point Depression and Boiling-Point Elevation / 350	
	Exercises / 353	
	References / 355	
<b>16</b>	<b>ACTIVITIES, EXCESS GIBBS FUNCTIONS, AND STANDARD STATES FOR NONELECTROLYTES</b>	<b>357</b>
16.1	Definitions of Activities and Activity Coefficients / 358	
	Activity / 358	
	Activity Coefficient / 358	
16.2	Choice of Standard States / 359	
	Gases / 359	
	Liquids and Solids / 360	
16.3	Gibbs Function and the Equilibrium Constant in Terms of Activity / 365	
16.4	Dependence of Activity on Pressure / 367	
16.5	Dependence of Activity on Temperature / 368	
	Standard Partial Molar Enthalpies / 368	
	Equation for Temperature Derivative of the Activity / 369	
16.6	Standard Entropy / 370	
16.7	Deviations from Ideality in Terms of Excess Thermodynamic Functions / 373	
	Representation of $G_m^E$ as a Function of Composition / 374	
16.8	Regular Solutions and Henry's Law / 376	
16.9	Regular Solutions and Limited Miscibility / 378	
	Exercises / 381	
	References / 384	

<b>17</b>	<b>DETERMINATION OF NONELECTROLYTE ACTIVITIES AND EXCESS GIBBS FUNCTIONS FROM EXPERIMENTAL DATA</b>	<b>385</b>
17.1	Activity from Measurements of Vapor Pressure / 385	
	Solvent / 385	
	Solute / 386	
17.2	Excess Gibbs Function from Measurement of Vapor Pressure / 388	
17.3	Activity of a Solute from Distribution between Two Immiscible Solvents / 391	
17.4	Activity from Measurement of Cell Potentials / 393	
17.5	Determination of the Activity of One Component from the Activity of the Other / 397	
	Calculation of Activity of Solvent from That of Solute / 398	
	Calculation of Activity of Solute from That of Solvent / 399	
17.6	Measurements of Freezing Points / 400	
	Exercises / 401	
	References / 406	
<b>18</b>	<b>CALCULATION OF PARTIAL MOLAR QUANTITIES AND EXCESS MOLAR QUANTITIES FROM EXPERIMENTAL DATA: VOLUME AND ENTHALPY</b>	<b>407</b>
18.1	Partial Molar Quantities by Differentiation of $J$ as a Function of Composition / 407	
	Partial Molar Volume / 409	
	Partial Molar Enthalpy / 413	
	Enthalpies of Mixing / 414	
	Enthalpies of Dilution / 417	
18.2	Partial Molar Quantities of One Component from those of Another Component by Numerical Integration / 420	
	Partial Molar Volume / 421	
	Partial Molar Enthalpy / 421	
18.3	Analytic Methods for Calculation of Partial Molar Properties / 422	
	Partial Molar Volume / 422	
	Partial Molar Enthalpy / 423	
18.4	Changes in $J$ for Some Processes in Solutions / 423	
	Transfer Process / 423	
	Integral Process / 425	
18.5	Excess Properties: Volume and Enthalpy / 426	
	Excess Volume / 426	
	Excess Enthalpy / 426	
	Exercises / 427	
	References / 436	

<b>19</b>	<b>ACTIVITY, ACTIVITY COEFFICIENTS, AND OSMOTIC COEFFICIENTS OF STRONG ELECTROLYTES</b>	<b>439</b>
19.1	Definitions and Standard states for Dissolved Electrolytes / 440	
	Uni-univalent Electrolytes / 440	
	Multivalent Electrolytes / 443	
	Mixed Electrolytes / 446	
19.2	Determination of Activities of Strong Electrolytes / 448	
	Measurement of Cell Potentials / 449	
	Solubility Measurements / 453	
	Colligative Property Measurement: The Osmotic Coefficient / 455	
	Extension of Activity Coefficient Data to Additional Temperatures with Enthalpy of Dilution Data / 460	
19.3	Activity Coefficients of Some Strong Electrolytes / 462	
	Experimental Values / 462	
	Theoretical Correlation / 462	
	Exercises / 464	
	References / 470	
<b>20</b>	<b>CHANGES IN GIBBS FUNCTION FOR PROCESSES IN SOLUTIONS</b>	<b>471</b>
20.1	Activity Coefficients of Weak Electrolytes / 471	
20.2	Determination of Equilibrium Constants for Dissociation of Weak Electrolytes / 472	
	From Measurements of Cell Potentials / 473	
	From Conductance Measurements / 475	
20.3	Some Typical Calculations for $\Delta_f G_m^\circ$ / 480	
	Standard Gibbs Function for Formation of Aqueous Solute: HCl / 480	
	Standard Gibbs Function of Formation of Individual Ions: HCl / 482	
	Standard Gibbs Function for Formation of Solid Solute in Aqueous Solution / 482	
	Standard Gibbs Function for Formation of Ion of Weak Electrolyte / 484	
	Standard Gibbs Function for Formation of Moderately Strong Electrolyte / 485	
	Effect of Salt Concentration on Geological Equilibrium Involving Water / 486	
	General Comments / 486	
20.4	Entropies of Ions / 487	
	The Entropy of an Aqueous Solution of a Salt / 488	

	Entropy of Formation of Individual Ions / 488	
	Ion Entropies in Thermodynamic Calculations / 491	
	Exercises / 491	
	References / 496	
<b>21</b>	<b>SYSTEMS SUBJECT TO A GRAVITATIONAL OR A CENTRIFUGAL FIELD</b>	<b>499</b>
	21.1 Dependence of the Gibbs Function on External Field / 499	
	21.2 System in a Gravitational Field / 502	
	21.3 System in a Centrifugal Field / 505	
	Exercises / 509	
	References / 510	
<b>22</b>	<b>ESTIMATION OF THERMODYNAMIC QUANTITIES</b>	<b>511</b>
	22.1 Empirical Methods / 511	
	Group Contribution Method of Andersen, Beyer, Watson, and Yoneda / 512	
	Typical Examples of Estimating Entropies / 516	
	Other Methods / 522	
	Accuracy of the Approximate Methods / 522	
	Equilibrium in Complex Systems / 523	
	Exercises / 523	
	References / 524	
<b>23</b>	<b>CONCLUDING REMARKS</b>	<b>527</b>
	References / 529	
	<b>APPENDIX A PRACTICAL MATHEMATICAL TECHNIQUES</b>	<b>531</b>
	A.1 Analytical Methods / 531	
	Linear Least Squares / 531	
	Nonlinear Least Squares / 534	
	A.2 Numerical and Graphical Methods / 535	
	Numerical Differentiation / 535	
	Numerical Integration / 538	
	Use of the Digital Computer / 540	
	Graphical Differentiation / 541	
	Graphical Integration / 542	
	Exercises / 542	
	References / 543	
	<b>INDEX</b>	<b>545</b>



# PREFACE

---

This is the seventh edition of a book that was first published by Professor Klotz in 1950. He died while we were preparing this edition, and it is dedicated to his memory.

Many friends have asked why a new edition of a thermodynamics text is necessary, because the subject has not changed basically since the work of J. Willard Gibbs. One answer is given by the statement of Lord Rayleigh in a letter to Gibbs\*,

The original version, though now attracting the attention it deserves, is too condensed and too difficult for most, I might say all, readers.

This statement follows a request for Gibbs to prepare a new edition of, or a treatise founded on, the original. Those of us who still have difficulty with Gibbs are in good company. Planck wrote his famous textbook on thermodynamics independently of Gibbs, but subsequent authors were trying to make the work of Gibbs more easily understood than the Gibbs original. Similarly, each new edition of an established text tries to improve its pedagogical methods and bring itself up to date with recent developments or applications. This is the case with this edition.

One hundred fifty years ago, the two classic laws of thermodynamics were formulated independently by Kelvin and by Clausius, essentially by making the Carnot theorem and the Joule–Mayer–Helmholtz principle of conservation of energy concordant with each other. At first the physicists of the middle 1800s focused primarily on heat engines, in part because of the pressing need for efficient sources of power. At that time, chemists, who are rarely at ease with the calculus, shied away from

\*Quoted in E. B. Wilson, *Proc. Natl. Acad. Sci., U. S. A.* **31**, 34–38 (1945).

thermodynamics. In fact, most of them probably found the comment of the distinguished philosopher and mathematician August Comte very congenial:

Every attempt to employ mathematical methods in the study of chemical questions must be considered profoundly irrational. If mathematical analysis should ever hold a prominent place in chemistry—an aberration which is happily impossible—it would occasion a rapid and widespread degradation of that science.

—A. Comte, *Cours de philosophie positive*, Bachelier, Paris, 1838, Vol. 3, pp. 28–29

By the turn of the nineteenth into the twentieth century, the work of Gibbs, Helmholtz, Planck, van't Hoff, and others showed that the scope of thermodynamic concepts could be expanded into chemical systems and transformations. Consequently, during the first 50 years of the twentieth century, thermodynamics progressively pervaded all aspects of chemistry and flourished as a recognizable entity on its own—chemical thermodynamics.

By the middle of the twentieth century, biochemistry became increasingly understood in molecular and energetic terms, so thermodynamic concepts were extended into disciplines in the basic life sciences and their use has expanded progressively. During this same period, geology and materials science have adapted thermodynamics to their needs. Consequently, the successive revisions of this text incorporated examples and exercises representative of these fields.

In general, the spirit and format of the previous editions of this text have been maintained. The fundamental objective of the book remains unchanged: to present to the student the logical foundations and interrelationships of thermodynamics and to teach the student the methods by which the basic concepts may be applied to practical problems. In the treatment of basic concepts, we have adopted the classic, or phenomenological, approach to thermodynamics and have excluded the statistical viewpoint. This attitude has several pedagogical advantages. First, it permits the maintenance of a logical unity throughout the book. In addition, it offers an opportunity to stress the “operational” approach to abstract concepts. Furthermore, it makes some contribution toward freeing the student from a perpetual yearning for a mechanical analog for every new concept that is introduced.

A great deal of attention is paid in this text to training the student in the application of the basic concepts to problems that are commonly encountered by the chemist, the biologist, the geologist, and the materials scientist. The mathematical tools that are necessary for this purpose are considered in more detail than is usual. In addition, computational techniques, graphical, numerical, and analytical, are described fully and are used frequently, both in illustrative and in assigned problems. Furthermore, exercises have been designed to simulate more than in most texts the type of problem that may be encountered by the practicing scientist. Short, unrelated exercises are thus kept to a minimum, whereas series of computations or derivations, which illustrate a technique or principle of general applicability, are emphasized.

We have also made a definite effort to keep this volume to a manageable size. Too often, a textbook that attempts to be exhaustive in its coverage merely serves to overwhelm the student. On the other hand, if a student can be guided to a sound grasp of

the fundamental principles and be shown how these can be applied to a few typical problems, that individual will be capable of examining other special topics independently or with the aid of one of the excellent comprehensive treatises that are available.

Another feature of this book is the extensive use of subheadings in outline form to indicate the position of a given topic in the general sequence of presentation. In using this method of presentation, we have been influenced strongly by the viewpoint expressed so aptly by Poincare:

The order in which these elements are placed is much more important than the elements themselves. If I have the feeling . . . of this order, so as to perceive at a glance the reasoning as a whole, I need no longer fear lest I forget one of the elements, for each of them will take its allotted place in the array, and that without any effort of memory on my part.  
—H. Poincare, *The Foundations of Science*, translated by G. B. Halsted, Science Press, 1913.

It is a universal experience of teachers, that students can to retain a body of information much more effectively if they are aware of the place of the parts in the whole.

Although thermodynamics has not changed fundamentally since the first edition was published, conventions and pedagogical approaches have changed, and new applications continue to appear. A new edition prompts us to take note of the progressive expansion in range of areas in science and engineering that have been illuminated by thermodynamic concepts and principles. We have taken the opportunity, therefore, to revise our approach to some topics and to add problems that reflect new applications. We have continued to take advantage of the resources available on the World Wide Web so that students can gain access to databases available online.

We are indebted to the staff of Seeley-Mudd Science and Engineering Library for their assistance in obtaining resource materials. R.M.R. is grateful to the Chemistry Department of Northwestern University for its hospitality during his extended visiting appointment. We thank Warren Peticolas for his comments on several chapters and for his helpful suggestions on Henry's law. We are grateful to E. Virginia Hobbs for the index and to Sheree Van Vreede for her copyediting. We thank Rubin Battino for his careful reading of the entire manuscript.

A solutions manual that contains solutions to most exercises in the text is available.

While this edition was being prepared, the senior author, Irving M. Klotz, died. He will be sorely missed by colleagues, students, and the scientific community. This edition is dedicated to his memory.

ROBERT M. ROSENBERG

*Evanston, Illinois*





# CHAPTER 1

---

## INTRODUCTION

---

### 1.1 ORIGINS OF CHEMICAL THERMODYNAMICS

An alert young scientist with only an elementary background in his or her field might be surprised to learn that a subject called “thermodynamics” has any relevance to chemistry, biology, material science, and geology. The term *thermodynamics*, when taken literally, implies a field concerned with the mechanical action produced by heat. Lord Kelvin invented the name to direct attention to the *dynamic* nature of *heat* and to contrast this perspective with previous conceptions of heat as a type of fluid. The name has remained, although the applications of the science are much broader than when Kelvin created its name.

In contrast to mechanics, electromagnetic field theory, or relativity, where the names of Newton, Maxwell, and Einstein stand out uniquely, the foundations of thermodynamics originated from the thinking of over half a dozen individuals: Carnot, Mayer, Joule, Helmholtz, Rankine, Kelvin, and Clausius [1]. Each person provided crucial steps that led to the grand synthesis of the two classic laws of thermodynamics.

Eighteenth-century and early nineteenth-century views of the nature of heat were founded on the principle of conservation of caloric. This principle is an eminently attractive basis for rationalizing simple observations such as temperature changes that occur when a cold object is placed in contact with a hot one. The cold object seems to have extracted something (caloric) from the hot one. Furthermore,

if both objects are constituted of the same material, and the cold object has twice the mass of the hot one, then we observe that the increase in temperature of the former is only half the decrease in temperature of the latter. A conservation principle develops naturally. From this principle, the notion of the flow of a substance from the hot to the cold object appears almost intuitively, together with the concept that the total quantity of the caloric can be represented by the product of the mass multiplied by the temperature change. With these ideas in mind, Black was led to the discovery of specific heat, heat of fusion, and heat of vaporization. Such successes established the concept of caloric so solidly and persuasively that it blinded even the greatest scientists of the early nineteenth century. Thus, they missed seeing well-known facts that were common knowledge even in primitive cultures, for example, that heat can be produced by friction. It seems clear that the earliest of the founders of thermodynamics, Carnot, accepted conservation of caloric as a basic axiom in his analysis [2] of the heat engine (although a few individuals [3] claim to see an important distinction in the contexts of Carnot's uses of "calorique" versus "chaleur").

Although Carnot's primary objective was to evaluate the mechanical efficiency of a steam engine, his analysis introduced certain broad concepts whose significance goes far beyond engineering problems. One of these concepts is the reversible process, which provides for thermodynamics the corresponding idealization that "frictionless motion" contributes to mechanics. The idea of "reversibility" has applicability much beyond ideal heat engines. Furthermore, it introduces continuity into the visualization of the process being considered; hence, it invites the introduction of the differential calculus. It was Clapeyron [4] who actually expounded Carnot's ideas in the notation of calculus and who thereby derived the vapor pressure equation associated with his name as well as the performance characteristics of ideal engines.

Carnot also leaned strongly on the analogy between a heat engine and a hydrodynamic one (the water wheel) for, as he said:

we can reasonably compare the motive power of heat with that of a head of water.

For the heat engine, one needs two temperature levels (a boiler and a condenser) that correspond to the two levels in height of a waterfall. For a waterfall, the quantity of water discharged by the wheel at the bottom level is the same as the quantity that entered originally at the top level, with the work being generated by the drop in gravitational level. Therefore, Carnot postulated that a corresponding thermal quantity, "calorique," was carried by the heat engine from a high temperature to a low one; the heat that entered at the upper temperature level was conserved and exited in exactly the same quantity at the lower temperature, with work having been produced during the drop in temperature level. Using this postulate, he was able to answer in a general way the long-standing question of whether steam was suited uniquely for a heat engine; he did this by showing that in the ideal engine any other substance would be just as efficient. It was also from this construct that Kelvin subsequently realized that one could establish an absolute temperature scale independent of the properties of any substance.

When faced in the late 1840s with the idea of conservation of (heat plus work) proposed by Joule, Helmholtz, and Mayer, Kelvin at first rejected it (as did the Proceedings of the Royal Society when presented with one of Joule's manuscripts) because conservation of energy (work plus heat) was inconsistent with the Carnot analysis of the fall of an *unchanged* quantity of heat through an ideal thermal engine to produce work. Ultimately, however, between 1849 and 1851, Kelvin and Clausius, each reading the other's papers closely, came to recognize that Joule and Carnot could be made concordant if it was assumed that only *part* of the heat entering the Carnot engine at the high temperature was released at the lower level and that the *difference* was converted into work. Clausius was the first to express this in print. Within the next few years, Kelvin developed the mathematical expression  $\Sigma Q/T = 0$  for "the second fundamental law of the dynamical theory of heat" and began to use the word *thermodynamic*, which he had actually coined earlier. Clausius's analysis [5] led him, in turn, to the mathematical formulation of  $\int dQ/T \geq 0$  for the second law; in addition, he invented the term *entropy* (as an alternative to Kelvin's "dissipation of energy"), for, as he says,

I hold it better to borrow terms for important magnitudes from the ancient languages so that they may be adopted unchanged in all modern languages.

Thereafter, many individuals proceeded to show that the two fundamental laws, explicitly so-called by Clausius and Kelvin, were applicable to all types of macroscopic natural phenomena and not just to heat engines. During the latter part of the nineteenth century, then, the scope of thermodynamics widened greatly. It became apparent that the same concepts that allow one to predict the maximum efficiency of a heat engine apply to other energy transformations, including transformations in chemical, biological, and geological systems in which an energy change is not obvious. For example, thermodynamic principles permit the computation of the maximum yield in the synthesis of ammonia from nitrogen and hydrogen under a variety of conditions of temperature and pressure, with important consequences to the chemical fertilizer industry. Similarly, the equilibrium distribution of sodium and potassium ions between red blood cells and blood plasma can be calculated from thermodynamic relationships. It was the observation of deviations from an equilibrium distribution that led to a search for mechanisms of active transport of these alkali metal ions across the cell membrane. Also, thermodynamic calculations of the effect of temperature and pressure on the transformation between graphite and diamond have generated hypotheses about the geological conditions under which natural diamonds can be made.

For these and other phenomena, thermal and work quantities, although controlling factors, are only of indirect interest. Accordingly, a more refined formulation of thermodynamic principles was established, particularly by Gibbs [6] and, later, independently by Planck [7], that emphasized the nature and use of several special functions or potentials to describe the state of a system. These functions have proved convenient and powerful in prescribing the rules that govern chemical and physical transitions. Therefore, in a sense, the name "energetics" is more descriptive than is

“thermodynamics” insofar as applications to chemistry are concerned. More commonly, one affixes the adjective “chemical” to thermodynamics to indicate the change in emphasis and to modify the literal and original meaning of thermodynamics.

## 1.2 OBJECTIVES OF CHEMICAL THERMODYNAMICS

In practice, the primary objective of chemical thermodynamics is to establish a criterion for determining the feasibility or spontaneity of a given physical or chemical transformation. For example, we may be interested in a criterion for determining the feasibility of a spontaneous transformation from one phase to another, such as the conversion of graphite to diamond, or the spontaneous direction of a metabolic reaction that occurs in a cell. On the basis of the first and second laws of thermodynamics, which are expressed in terms of Gibbs’s functions, several additional theoretical concepts and mathematical functions have been developed that provide a powerful approach to the solution of these questions.

Once the spontaneous direction of a natural process is determined, we may wish to know how far the process will proceed before reaching equilibrium. For example, we might want to find the maximum yield of an industrial process, the equilibrium solubility of atmospheric carbon dioxide in natural waters, or the equilibrium concentration of a group of metabolites in a cell. Thermodynamic methods provide the mathematical relations required to estimate such quantities.

Although the main objective of chemical thermodynamics is the analysis of spontaneity and equilibrium, the methods also are applicable to many other problems. For example, the study of phase equilibria, in ideal and nonideal systems, is basic to the intelligent use of the techniques of extraction, distillation, and crystallization; to metallurgical operations; to the development of new materials; and to the understanding of the species of minerals found in geological systems. Similarly, the energy changes that accompany a physical or chemical transformation, in the form of either heat or work, are of great interest, whether the transformation is the combustion of a fuel, the fission of a uranium nucleus, or the transport of a metabolite against a concentration gradient. Thermodynamic concepts and methods provide a powerful approach to the understanding of such problems.

## 1.3 LIMITATIONS OF CLASSIC THERMODYNAMICS

Although descriptions of chemical change are permeated with the terms and language of molecular theory, the concepts of classic thermodynamics are independent of molecular theory; thus, these concepts do not require modification as our knowledge of molecular structure changes. This feature is an advantage in a formal sense, but it is also a distinct limitation because we cannot obtain information at a molecular level from classic thermodynamics.

In contrast to molecular theory, classic thermodynamics deals only with measurable properties of matter in bulk (for example, pressure, temperature, volume, cell potential,

magnetic susceptibility, and heat capacity). It is an empirical and phenomenological science, and in this sense, it resembles classic mechanics. The latter also is concerned with the behavior of macroscopic systems, with the position and the velocity of a body as a function of time, without regard to the body's molecular nature.

*Statistical mechanics* (or *statistical thermodynamics*) is the science that relates the properties of individual molecules and their interactions to the empirical results of classical thermodynamics. The laws of classic and quantum mechanics are applied to molecules; then, by suitable statistical averaging methods, the rules of macroscopic behavior that would be expected from an assembly of many such molecules are formulated. Because classical thermodynamic results are compared with statistical averages over very large numbers of molecules, it is not surprising that fluctuation phenomena, such as Brownian motion, the "shot effect," or certain turbidity phenomena, cannot be treated by classical thermodynamics. Now we recognize that all such phenomena are expressions of local microscopic fluctuations in the behavior of a relatively few molecules that deviate randomly from the average behavior of the entire assembly. In this submicroscopic region, such random fluctuations make it impossible to assign a definite value to properties such as temperature or pressure. However, classical thermodynamics is predicated on the assumption that a definite and reproducible value always can be measured for such properties.

In addition to these formal limitations, limitations of a more functional nature also exist. Although the concepts of thermodynamics provide the foundation for the solution of many chemical problems, the answers obtained generally are not definitive. Using the language of the mathematician, we might say that classical thermodynamics can formulate *necessary* conditions but not *sufficient* conditions. Thus, a thermodynamic analysis may rule out a given reaction for the synthesis of some substance by indicating that such a transformation cannot proceed spontaneously under any set of available conditions. In such a case, we have a definitive answer. However, if the analysis indicates that a reaction may proceed spontaneously, no statement can be made from classical thermodynamics alone indicating that it will do so in any finite time.

For example, classic thermodynamic methods predict that the *maximum* equilibrium yield of ammonia from nitrogen and hydrogen is obtained at low temperatures. Yet, under these optimum thermodynamic conditions, the rate of reaction is so slow that the process is not practical for industrial use. Thus, a smaller equilibrium yield at high temperature must be accepted to obtain a suitable reaction rate. However, although the thermodynamic calculations provide no assurance that an equilibrium yield will be obtained in a finite time, it was as a result of such calculations for the synthesis of ammonia that an intensive search was made for a catalyst that would allow equilibrium to be reached.

Similarly, specific catalysts called enzymes are important factors in determining what reactions occur at an appreciable rate in biological systems. For example, adenosine triphosphate is thermodynamically unstable in aqueous solution with respect to hydrolysis to adenosine diphosphate and inorganic phosphate. Yet this reaction proceeds very slowly in the absence of the specific enzyme adenosine triphosphatase. This combination of thermodynamic control of direction and enzyme control of rate makes possible the finely balanced system that is a living cell.

In the case of the graphite-to-diamond transformation, thermodynamic results predict that graphite is the stable allotrope at a fixed temperature at all pressures below the transition pressure and that diamond is the stable allotrope at all pressures above the transition pressure. But diamond is not converted to graphite at low pressures for kinetic reasons. Similarly, at conditions at which diamond is the thermodynamically stable phase, diamond can be obtained from graphite only in a narrow temperature range just below the transition temperature, and then only with a catalyst or at a pressure sufficiently high that the transition temperature is about 2000 K.

Just as thermodynamic methods provide only a *limiting value* for the yield of a chemical reaction, so also do they provide only a limiting value for the work obtainable from a chemical or physical transformation. Thermodynamic functions predict the work that may be obtained if the reaction is carried out with infinite slowness, in a so-called reversible manner. However, it is impossible to specify the actual work obtained in a real or natural process in which the time interval is finite. We can state, nevertheless, that the real work will be less than the work obtainable in a reversible situation.

For example, thermodynamic calculations will provide a value for the *maximum* voltage of a storage battery—that is, the voltage that is obtained when no current is drawn. When current is drawn, we can predict that the voltage will be less than the maximum value, but we cannot predict how much less. Similarly, we can calculate the *maximum* amount of heat that can be transferred from a cold environment into a building by the expenditure of a certain amount of work in a heat pump, but the actual performance will be less satisfactory. Given a nonequilibrium distribution of ions across a cell membrane, we can calculate the *minimum* work required to maintain such a distribution. However, the actual process that occurs in the cell requires much more work than the calculated value because the process is carried out irreversibly.

Although classical thermodynamics can treat only limiting cases, such a restriction is not nearly as severe as it may seem at first glance. In many cases, it is possible to approach equilibrium very closely, and the thermodynamic quantities coincide with actual values, within experimental error. In other situations, thermodynamic analysis may rule out certain reactions under any conditions, and a great deal of time and effort can be saved. Even in their most constrained applications, such as limiting solutions within certain boundary values, thermodynamic methods can reduce materially the amount of experimental work necessary to yield a definitive answer to a particular problem.

## REFERENCES

1. D. S. L. Cardwell, *From Watt to Clausius: The Rise of Thermodynamics in the Early Industrial Age*, Cornell University Press, Ithaca, NY, 1971.
2. S. Carnot, *Reflexions sur la puissance motrice du feu*, Bachelier, Paris, 1824; E. Mendoza, ed., *Reflections on the Motive Power of Fire by Sadi Carnot*, Dover, New York, 1960; T. S. Kuhn, *Am. J. Phys.* **23**, 95 (1955).

3. H. L. Callendar, *Proc. Phys. Soc. (London)* **23**, 153 (1911); V. LaMer, *Am. J. Phys.* **23**, 95 (1955).
4. E. Clapeyron, *J. Ecole Polytech. (Paris)* **14**, 153 (1834); Mendoza, *Motive Power of Fire*.
5. R. Clausius, *Pogg. Ann. Series III* **79**, 368, 500 (1859); *Series V* **5**, 353 (1859); *Ann. Phys.* **125**, 353 (1865); Mendoza, *Motive Power of Fire*.
6. J. W. Gibbs, *Trans. Conn. Acad. Sci.* **3**, 228 (1876); *The Collected Works of J Willard Gibbs*, Yale University Press, New Haven, CT, 1928; reprinted 1957.
7. M. Planck, *Treatise on Thermodynamics*, Berlin, 1897, Translated from the seventh German edition, Dover Publications, New York; M. Born, *Obituary Notices of Fellows of the Royal Society*, **6**, 161 (1948).





## CHAPTER 2

---

# MATHEMATICAL PREPARATION FOR THERMODYNAMICS

---

Ordinary language is deficient in varying degrees for expressing the ideas and findings of science. An exact science must be founded on precise definitions that are difficult to obtain by verbalization. Mathematics, however, offers a precise mode of expression. Mathematics also provides a rigorous logical procedure and a device for the development in succinct form of a long and often complicated argument. A long train of abstract thought can be condensed with full preservation of continuity into brief mathematical notation; thus, we can proceed readily with additional steps in reasoning without carrying in our minds the otherwise overwhelming burden of all previous steps in the sequence. Yet, we must be able to express the results of our investigations in plain language if we are to communicate our results to a general audience.

Most branches of theoretical science can be expounded at various levels of abstraction. The most elegant and formal approach to thermodynamics, that of Caratheodory [1], depends on a familiarity with a special type of differential equation (Pfaff equation) with which the usual student of chemistry is unacquainted. However, an introductory presentation of thermodynamics follows best along historical lines of development, for which only the elementary principles of calculus are necessary. We follow this approach here. Nevertheless, we also discuss exact differentials and Euler's theorem, because many concepts and derivations can be presented in a more satisfying and precise manner with their use.

## 2.1 VARIABLES OF THERMODYNAMICS

### Extensive and Intensive Quantities [2]

In the study of thermodynamics we can distinguish between variables that are independent of the quantity of matter in a system, the *intensive variables*, and variables that depend on the quantity of matter. Of the latter group, those variables whose values are directly proportional to the quantity of matter are of particular interest and are simple to deal with mathematically. They are called *extensive variables*. Volume and heat capacity are typical examples of *extensive* variables, whereas temperature, pressure, viscosity, concentration, and molar heat capacity are examples of *intensive* variables.

### Units and Conversion Factors

The base units of measurement under the Systeme International d'Unites, or SI units, are given in Table 2.1 [3].

Some SI-derived units with special names are included in Table 2.2. The standard atmosphere may be used temporarily with SI units; it is defined to be equal to  $1.01325 \times 10^5$  Pa. The thermochemical calorie is no longer recommended as a unit of energy, but it is defined in terms of an SI unit, joules, symbol J, as 4.184 J [4]. The unit of volume, liter, symbol L, is now defined as  $1 \text{ dm}^3$ .

The authoritative values for physical constants and conversion factors used in thermodynamic calculations are assembled in Table 2.3. Furthermore, information about the proper use of physical quantities, units, and symbols can be found in several additional sources [5].

## 2.2 ANALYTIC METHODS

### Partial Differentiation

As the state of a thermodynamic system generally is a function of more than one independent variable, it is necessary to consider the mathematical techniques for expressing these relationships. Many thermodynamic problems involve only two independent variables, and the extension to more variables is generally obvious, so we will limit our illustrations to functions of two variables.

**Equation for the Total Differential.** Let us consider a specific example: the volume of a pure substance. The molar volume  $V_m$  is a function  $f$  only of the temperature  $T$  and pressure  $P$  of the substance; thus, the relationship can be written in general notation as

$$V_m = f(P, T) \quad (2.1)$$

**TABLE 2.1. Base SI Units<sup>a</sup>**

Quantity	Unit	Symbol	Definition
Length	meter	m	The meter is the length of the path traveled by light in vacuum during a time interval of 1/299, 792, 458 of a second.
Mass	kilogram	kg	The kilogram is the mass of the international prototype of the kilogram.
Time	second	s	The second is the duration of 9, 192, 631, 770 periods of the radiation corresponding to the transition between the two hyperfine levels of the ground state of the cesium-133 atom.
Electric current	ampere	A	The ampere is that current which, if maintained in two straight parallel conductors of infinite length of negligible cross section, and placed 1 m apart in vacuum, would produce between these conductors a force equal to $2 \times 10^{-7}$ newton per meter of length.
Thermodynamic temperature	kelvin	K	The kelvin is the fraction 1/273.16 of the thermodynamic temperature of the triple point of water.
Amount of substance <sup>b</sup>	mole	mol	The mole is the amount of substance of a system that contains as many elementary entities as there are atoms in 0.012 kg of Carbon 12.
Luminous intensity	candela	cd	The candela is the luminous intensity, in a given direction, of a source that emits monochromatic radiation of frequency $540 \times 10^{12}$ hertz and that has a radiant intensity in that direction of 1/683 watts per steradian.

<sup>a</sup>B. N. Taylor, *Guide to the Use of the International System of Units (SI)*, NIST Special Publication 811, Gaithersburg, MD, 1995. <http://www.physics.nist.gov/cuu/units/current.html>. <http://www.bipm.fr>.

<sup>b</sup>The amount of substance should be expressed in units of moles, with one mole being Avogadro's constant number of designated particles or groups of particles, whether these are electrons, atoms, molecules, or the number of molecules of reactants and products specified by a chemical equation.

in which the subscript “m” indicates a molar quantity. Using the principles of calculus [6], we can write for the total differential

$$dV_m = \left( \frac{\partial V_m}{\partial P} \right)_T dP + \left( \frac{\partial V_m}{\partial T} \right)_P dT \quad (2.2)$$

TABLE 2.2. SI-Derived Units

Quantity	Name	Symbol	Expression in Terms of Other Units
Force	newton	N	$\text{m kg s}^{-2}$
Pressure	pascal	Pa	$\text{N m}^{-2}$
	bar	bar	$\text{N m}^{-2}$
Energy, work, quantity of heat	joule	J	$\text{N m}$
Power	watt	W	$\text{J s}^{-1}$
Electric charge	coulomb	C	$\text{A s}$
Electric potential, electromotive force	volt	V	$\text{W A}^{-1}, \text{J C}^{-1}$
Celsius temperature	degree	$^{\circ}\text{C}$	K
	Celsius		
Heat capacity, entropy	joule per kelvin		$\text{J K}^{-1}$

For the special case of one mole of an ideal gas, Equation (2.1) becomes

$$V_m = \frac{RT}{P} = RT \left( \frac{1}{P} \right) \quad (2.3)$$

where  $R$  is the universal gas constant. As the partial derivatives are given by the expressions

$$\left( \frac{\partial V_m}{\partial P} \right)_T = - \frac{RT}{P^2} \quad (2.4)$$

TABLE 2.3. Fundamental Constants and Conversion Factors\*

Ice-point temperature, ( $0^{\circ}\text{C}$ )	= 273.15 Kelvins (K)
Gas constant, $R$	= 8.314471 $\text{J K}^{-1} \text{mol}^{-1}$ ( $\pm 15$ ) <sup>a</sup>
	= 1.987 calth $\text{K}^{-1} \text{mol}^{-1}$
	= 0.0820575 $\text{dm}^3 \text{atm K}^{-1} \text{mol}^{-1}$
Avogadro constant, $N_A, L$	= 6.02215 $\times 10^{23} \text{mol}^{-1}$ ( $\pm 107$ ) <sup>a</sup>
Faraday constant, $F$	= 96485.3383 $\text{C mol}^{-1}$ ( $\pm 839$ ) <sup>a</sup>
Elementary charge, $e$	= 1.60217653 $\times 10^{-19} \text{C}$ ( $\pm 143$ ) <sup>a</sup>
Boltzmann constant, $k$	= 1.3806505 $\times 10^{-23} \text{J/K}$ ( $\pm 24$ ) <sup>a</sup>

<sup>a</sup>2002 CODATA recommended values of the Fundamental Physical Constants, ICSU-CODATA Task Group on Fundamental Constants, P. J. Mohr and B. N. Taylor, *Rev. Mod. Phys.*, **77**, 1 (2005). (<http://physics.nist.gov/cuu/Constants>). Uncertainties are in the last two digits of each value.

\*Uncertainties are in the last significant figures of the quantity.

and

$$\left(\frac{\partial V_m}{\partial T}\right)_P = \frac{R}{P} \quad (2.5)$$

the total differential for the special case of the ideal gas can be obtained by substituting from Equations (2.4) and (2.5) into Equation (2.2) and is given by the relationship

$$dV_m = -\frac{RT}{P^2}dP + \frac{R}{P}dT \quad (2.6)$$

We shall have frequent occasion to use this expression.

**Conversion Formulas.** Often no convenient experimental method exists for evaluating a derivative needed for the numerical solution of a problem. In this case we must convert the partial derivative to relate it to other quantities that are readily available. The key to obtaining an expression for a particular partial derivative is to start with the total derivative for the dependent variable and to realize that a derivative can be obtained as the ratio of two differentials [8]. For example, let us convert the derivatives of the volume function discussed in the preceding section.

1. We can obtain a formula for  $(\partial P/\partial T)_V$  by using Equation (2.2) for the total differential of  $V$  as a function of  $T$  and  $P$  and dividing both sides by  $dT$ . Keeping in mind that  $dV_m = 0$ , we obtain

$$\frac{dV_m}{dT} = 0 = \left(\frac{\partial V_m}{\partial P}\right)_T \frac{dP}{dT} + \left(\frac{\partial V_m}{\partial T}\right)_P \quad (2.7)$$

Now, if we indicate explicitly for the second factor of the first term on the right side that  $V_m$  is constant, and if we rearrange terms, we obtain

$$\left(\frac{\partial P}{\partial T}\right)_V = \frac{-\left(\frac{\partial V_m}{\partial T}\right)_P}{\left(\frac{\partial V_m}{\partial P}\right)_T} \quad (2.8)$$

Thus, if we needed  $(\partial P/\partial T)_V$  in some situation but had no method of direct evaluation, we could establish its value from the more readily measurable  $(\partial V_m/\partial P)_T$  and  $(\partial V_m/\partial T)_P$ . These coefficients are related to the *coefficient of thermal expansion*  $\alpha$ ,  $(1/V)(\partial V/\partial T)_P$  and to the *coefficient of compressibility*  $\beta$ ,  $-(1/V)(\partial V/\partial P)_T$ .

We can verify the validity of Equation (2.8) for an ideal gas by evaluating both sides explicitly and showing that the equality holds. The values of the

partial derivatives can be determined by reference to Equations (2.4) and (2.5), and the following deductions can be made:

$$\left(\frac{\partial P}{\partial T}\right)_V = \frac{-R/P}{-RT/P^2} = \frac{P}{T} = \frac{R}{V_m} \quad (2.9)$$

2. We can obtain a formula for  $(\partial T/\partial P)_V$  by dividing Equation (2.2) by  $dP$  to find  $dV_m/dP$  and by imposing the restriction that  $V_m$  be constant. Thus, we obtain

$$\frac{dV_m}{dP} = 0 = \left(\frac{\partial V_m}{\partial P}\right)_T + \left(\frac{\partial V_m}{\partial T}\right)_P \left(\frac{\partial T}{\partial P}\right)_V$$

Rearranging terms, we have

$$\left(\frac{\partial V_m}{\partial P}\right)_T = -\left(\frac{\partial V_m}{\partial T}\right)_P \left(\frac{\partial T}{\partial P}\right)_V \quad (2.10)$$

or, alternatively,

$$\left(\frac{\partial T}{\partial P}\right)_V = -\frac{(\partial V_m/\partial P)_T}{(\partial V_m/\partial T)_P} \quad (2.11)$$

3. From Equations (2.8) and (2.11), we infer a third relationship

$$\left(\frac{\partial P}{\partial T}\right)_V = \frac{1}{\left(\frac{\partial P}{\partial P}\right)_V} \quad (2.12)$$

Thus, we see again that the derivatives can be manipulated practically as if they were fractions.

4. A fourth relationship is useful for problems in which a new independent variable is introduced. For example, we could consider the volume  $V$  of a pure substance as a function of pressure and energy  $U$ .

$$V = g(U, P)$$

We then may wish to evaluate the partial derivative  $(\partial V_m/\partial P)_U$  that is, the change of volume with change in pressure at constant energy. A suitable expression for this derivative in terms of other partial derivatives can be obtained from Equation (2.2) by dividing  $dV_m$  by  $dP$  and explicitly adding the restriction that  $U$  is to be held constant. The result obtained is the relationship

$$\left(\frac{\partial V_m}{\partial P}\right)_U = \left(\frac{\partial V_m}{\partial P}\right)_T + \left(\frac{\partial V_m}{\partial T}\right)_P \left(\frac{\partial T}{\partial P}\right)_U \quad (2.13)$$

5. A fifth formula, for use in situations in which a new variable  $X(P,T)$  is to be introduced, is an example of the chain rule of differential calculus. The formula is

$$\left(\frac{\partial V_m}{\partial T}\right)_P = \left(\frac{\partial V_m}{\partial X}\right)_P \left(\frac{\partial X}{\partial T}\right)_P \quad (2.14)$$

These illustrations, which are based on the example of the volume function, are typical of the type of conversion that is required so frequently in thermodynamic manipulations.

### Exact Differentials

Many thermodynamic relationships can be derived easily by using the properties of the exact differential. As an introduction to the characteristics of exact differentials, we shall consider the properties of certain simple functions used in connection with a gravitational field. We will use a capital  $D$  to indicate an inexact differential, as in  $DW$ , and a small  $d$  to indicate an exact differential, as in  $dU$ .

**Example of the Gravitational Field.** Let us compare the change in potential energy and the work done in moving a large boulder up a hill against the force of gravity. From elementary physics, we see that these two quantities,  $\Delta U$  and  $W$ , differ in the following respects.

1. The change in potential energy depends only on the initial and final heights of the stone, whereas the work done (as well as the heat generated) depends on the path used. That is, the quantity of work expended if we use a pulley and tackle to raise the boulder directly will be much less than if we have to move the object up the hill by pushing it over a long, muddy, and tortuous road. However, the change in potential energy is the same for both paths as long as they have the same starting point and the same end point.
2. An explicit expression for the potential energy  $U$  exists, and this function can be differentiated to give  $dU$ , whereas no explicit expression for  $W$  that leads to  $DW$  can be obtained. The function for the potential energy is a particularly simple one for the gravitational field because two of the space coordinates drop out and only the height  $h$  remains. That is,

$$U = \text{constant} + mgh \quad (2.15)$$

The symbols  $m$  and  $g$  have the usual significance of mass and acceleration because of gravity, respectively.

3. A third difference between  $\Delta U$  and  $W$  lies in the values obtained if one uses a cyclic path, as in moving the boulder up the hill and then back down to the



initial point. For such a cyclic or closed path, the net change in potential energy is zero because the final and initial points are identical. This fact is represented by the equation

$$\oint dU = 0 \quad (2.16)$$

in which  $\oint$  denotes the integral around a closed path. However, the value of  $W$  for a complete cycle usually is not zero, and the value obtained depends on the particular cyclic path that is taken.

**General Formulation.** To understand the notation for exact differentials that generally is adopted, we shall express the total differential of a general function  $L(x, y)$  to indicate explicitly that the partial derivatives are functions of the independent variables ( $x$  and  $y$ ), and that the differential is a function of the independent variables and their differentials ( $dx$  and  $dy$ ). That is,

$$dL(x, y, dx, dy) = M(x, y)dx + N(x, y)dy \quad (2.17)$$

in which

$$M(x, y) = \left( \frac{\partial L}{\partial x} \right)_y \quad (2.18)$$

and

$$N(x, y) = \left( \frac{\partial L}{\partial y} \right)_x \quad (2.19)$$

The notation in Equation (2.17) makes explicit the notion that, in general,  $dL$  is a function of the path chosen. Using this expression, we can summarize the characteristics of an exact differential as follows:

1. A function  $f(x, y)$  exists, such that

$$df(x, y) = dL(x, y, dx, dy) \quad (2.20)$$

That is, the differential is a function only of the coordinates and is independent of the path.

2. The value of the integral over any specified path, that is, the line integral [7]

$$\int_1^2 dL(x, y, dx, dy) = \int_1^2 df(x, y) \quad (2.21)$$

and depends only on the initial and final states and is independent of the path between them.

3. The line integral over a closed path is zero; that is,

$$\oint dL(x, y, dx, dy) = \oint df(x, y) = 0 \quad (2.22)$$

It is this last characteristic that is used most frequently in testing thermodynamic functions for exactness. If the differential  $dJ$  of a thermodynamic quantity  $J$  is exact, then  $J$  is called a *thermodynamic property* or a *state function*.

**Reciprocity Characteristic.** A common test of exactness of a differential expression  $dL(x, y, dx, dy)$  is whether the following relationship holds:

$$\left[ \frac{\partial}{\partial y} M(x, y) \right]_x = \left[ \frac{\partial}{\partial x} N(x, y) \right]_y \quad (2.23)$$

We can see that this relationship must be true if  $dL$  is exact, because in that case a function  $f(x, y)$  exists such that

$$dL(x, y, dx, dy) = df(x, y) = \left( \frac{\partial f}{\partial x} \right)_y dx + \left( \frac{\partial f}{\partial y} \right)_x dy \quad (2.24)$$

It follows from Equations (2.20) and (2.24) that

$$M(x, y) = \left( \frac{\partial f}{\partial x} \right)_y \quad (2.25)$$

and

$$N(x, y) = \left( \frac{\partial f}{\partial y} \right)_x \quad (2.26)$$

But, for the function  $f(x, y)$ , we know from the principles of calculus that

$$\frac{\partial}{\partial y} \left( \frac{\partial f}{\partial x} \right)_y = \frac{\partial^2 f}{\partial y \partial x} = \frac{\partial}{\partial x} \left( \frac{\partial f}{\partial y} \right)_x \quad (2.27)$$

That is, the order of differentiation is immaterial for any function of two variables. Therefore, if  $dL$  is exact, Equation (2.23) is correct [8].

To apply this criterion of exactness to a simple example, let us assume that we know only the expression for the total differential of the volume of an ideal gas [Equation (2.6)] and do not know whether this differential is exact. Applying

Equation (2.23) to Equation (2.6), we obtain

$$\frac{\partial}{\partial P} \left( \frac{R}{P} \right) = -\frac{R}{P^2} = \frac{\partial}{\partial T} \left( -\frac{RT}{P^2} \right)$$

Thus, we would know that the volume of an ideal gas is a thermodynamic property, even if we had not been aware previously of an explicit function for  $V_m$ .

## Homogeneous Functions

In connection with the development of the thermodynamic concept of partial molar quantities, it is desirable to be familiar with a mathematical relationship known as *Euler's theorem*. As this theorem is stated with reference to "homogeneous" functions, we will consider briefly the nature of these functions.

**Definition.** As a simple example, let us consider the function

$$u = ax^2 + bxy + cy^2 \quad (2.28)$$

If we replace the variables  $x$  and  $y$  by  $\lambda x$  and  $\lambda y$ , in which  $\lambda$  is a parameter, we can write

$$\begin{aligned} u^* &= u(\lambda x, \lambda y) = a(\lambda x)^2 + b(\lambda x)(\lambda y) + c(\lambda y)^2 \\ &= \lambda^2 ax^2 + \lambda^2 bxy + \lambda^2 cy^2 \\ &= \lambda^2 (ax^2 + bxy + cy^2) \\ &= \lambda^2 u \end{aligned} \quad (2.29)$$

As the net result of multiplying each independent variable by the parameter  $\lambda$  merely has been to multiply the function by  $\lambda^2$ , the function is called *homogeneous*. Because the exponent of  $\lambda$  in the result is 2, the function is of the *second degree*.

Now we turn to an example of experimental significance. If we mix certain quantities of benzene and toluene, which form an ideal solution, the total volume  $V$  will be given by the expression

$$V = V_{\text{mb}}^{\bullet} n_{\text{b}} + V_{\text{mt}}^{\bullet} n_{\text{t}} \quad (2.30)$$

in which  $n_{\text{b}}$  is the number of moles of benzene,  $V_{\text{mb}}^{\bullet}$  is the volume of one mole of pure benzene,  $n_{\text{t}}$  is the number of moles of toluene, and  $V_{\text{mt}}^{\bullet}$  is the volume of one mole of pure toluene. Suppose that we increase the quantity of each of the independent variables,  $n_{\text{b}}$  and  $n_{\text{t}}$ , by the same factor, say 2. We know from experience that the volume of the mixture will be doubled. In terms of Equation (2.30), we also can see that if we

replace  $n_b$  by  $\lambda n_b$  and  $n_t$  by  $\lambda n_t$ , the new volume  $V^*$  will be given by

$$\begin{aligned} V^* &= V_{mb}^{\bullet} \lambda n_b + V_{mt}^{\bullet} \lambda n_t \\ &= \lambda (V_{mb}^{\bullet} n_b + V_{mt}^{\bullet} n_t) \\ &= \lambda V \end{aligned} \quad (2.31)$$

The volume function then is homogeneous of the first degree, because the parameter  $\lambda$ , which factors out, occurs to the first power. Although an ideal solution has been used in this illustration, Equation (2.31) is true of all solutions. However, for nonideal solutions, the partial molar volume must be used instead of molar volumes of the pure components (see Chapter 9).

Proceeding to a general definition, we can say that a function,  $f(x, y, z, \dots)$  is homogeneous of degree  $n$  if, upon replacement of each independent variable by an arbitrary parameter  $\lambda$  times the variable, the function is multiplied by  $\lambda^n$ , that is, if

$$f(\lambda x, \lambda y, \lambda z, \dots) = \lambda^n f(x, y, z, \dots) \quad (2.32)$$

**Euler's Theorem.** The statement of the theorem can be made as follows: If  $f(x, y)$  is a homogeneous function of degree  $n$ , then

$$x \left( \frac{\partial f}{\partial x} \right)_y + y \left( \frac{\partial f}{\partial y} \right)_x = n f(x, y) \quad (2.33)$$

The proof can be carried out by the following steps. First let us represent the variables  $\lambda x$  and  $\lambda y$  by

$$x^* = \lambda x \quad (2.34)$$

and

$$y^* = \lambda y \quad (2.35)$$

Then, because  $f(x, y)$  is homogeneous

$$f^* = f(x^*, y^*) = f(\lambda x, \lambda y) = \lambda^n f(x, y) \quad (2.36)$$

The total differential  $df^*$  is given by

$$df^* = \frac{\partial f^*}{\partial x^*} dx^* + \frac{\partial f^*}{\partial y^*} dy^* \quad (2.37)$$

Hence

$$\frac{df^*}{d\lambda} = \frac{\partial f^*}{\partial x^*} \frac{dx^*}{d\lambda} + \frac{\partial f^*}{\partial y^*} \frac{dy^*}{d\lambda} \quad (2.38)$$

From Equations (2.34) and (2.35)

$$\frac{dx^*}{d\lambda} = x \quad (2.39)$$

and

$$\frac{dy^*}{d\lambda} = y \quad (2.40)$$

Consequently, Equation (2.38) can be rewritten as

$$\frac{df^*}{d\lambda} = \frac{\partial f^*}{\partial x^*} x + \frac{\partial f^*}{\partial y^*} y \quad (2.41)$$

Using the equalities in Equation (2.36) we can obtain

$$\frac{df^*}{d\lambda} = \frac{df(x^*, y^*)}{d\lambda} = \frac{d[\lambda^n f(x, y)]}{d\lambda} = n\lambda^{n-1} f(x, y) \quad (2.42)$$

Equating the right sides of Equations (2.41) and (2.42), we obtain

$$x \frac{\partial f^*}{\partial x^*} + y \frac{\partial f^*}{\partial y^*} = n\lambda^{n-1} f(x, y) \quad (2.43)$$

Because  $\lambda$  is an arbitrary parameter, Equation (2.43) must hold for any particular value. It must be true then for  $\lambda = 1$ . In such an instance, Equation (2.43) reduces to

$$x \left( \frac{\partial f}{\partial x} \right)_y + y \left( \frac{\partial f}{\partial y} \right)_x = nf(x, y)$$

This equation is Euler's theorem [Equation (2.33)].

As one example of the application of Euler's theorem, we refer again to the volume of a two-component system. Evidently the total volume is a function of the number of moles of each component:

$$V = f(n_1, n_2) \quad (2.44)$$

As we have seen previously, the volume function is known from experience to be homogeneous of the first degree; that is, if we double the number of moles of each component, we also double the total volume. In other words, a homogeneous

function of the first degree is an *extensive property*. Applying Euler's theorem, we obtain the relationship

$$n_1 \frac{\partial V}{\partial n_1} + n_2 \frac{\partial V}{\partial n_2} = V \quad (2.45)$$

or,

$$V = n_1 V_{m1} + n_2 V_{m2} \quad (2.46)$$

where  $V_{m1}$  and  $V_{m2}$  are the partial molar volumes of components 1 and 2, respectively. Equation (2.46) is applicable to all solutions and is the analog of Equation (2.30), which is applicable only to ideal solutions.

## EXERCISES

- 2.1. Calculate the conversion factor for changing liter atmosphere to (a) erg, (b) joule, and (c) calorie. Calculate the conversion factor for changing atmosphere to pascal and atmosphere to bar.
- 2.2. Calculate the conversion factor for changing calorie to (a) cubic meter atmosphere and (b) volt faraday.
- 2.3. The area  $a$  of a rectangle can be considered to be a function of the breadth  $b$  and the length  $l$ :

$$a = bl$$

The variables  $b$  and  $l$  are considered to be the independent variables;  $a$  is the dependent variable. Other possible dependent variables are the perimeter  $p$

$$p = 2b + 2l$$

and the diagonal  $d$

$$d = (b^2 + l^2)^{\frac{1}{2}}$$

- a. Derive expressions for the following partial derivatives in terms of  $b$  and  $l$ , or calculate numerical answers:

$$\left(\frac{\partial a}{\partial l}\right)_b \quad \left(\frac{\partial l}{\partial b}\right)_a \quad \left(\frac{\partial p}{\partial l}\right)_b \quad \left(\frac{\partial l}{\partial b}\right)_p$$

$$\left(\frac{\partial d}{\partial b}\right)_l \quad \left(\frac{\partial p}{\partial b}\right)_l \quad \left(\frac{\partial a}{\partial b}\right)_l$$

- b. Derive suitable conversion expressions in terms of the partial derivatives given in (a) for each of the following derivatives; then evaluate the results in terms of  $b$  and  $l$ . (Do not substitute the equation for  $p$  or  $d$  into that for  $a$ .)

$$\left(\frac{\partial a}{\partial b}\right)_d \quad \left(\frac{\partial b}{\partial p}\right)_l \quad \left(\frac{\partial a}{\partial b}\right)_p$$

- c. Derive suitable conversion expressions in terms of the preceding partial derivatives for each of the following derivatives; then evaluate the results in terms of  $b$  and  $l$ :

$$\left(\frac{\partial p}{\partial b}\right)_d \quad \left(\frac{\partial a}{\partial p}\right)_l \quad \left(\frac{\partial b}{\partial p}\right)_d \quad \left(\frac{\partial a}{\partial p}\right)_d$$

- 2.4. In a right triangle, such as that illustrated in Figure 2.1, the following relationships are valid:

$$D^2 = H^2 + B^2$$

$$P = H + B + D$$

$$A = (1/2)BH$$

- a. Given the special conditions:

$$H = 1000 \text{ cm}$$

$$\left(\frac{\partial H}{\partial B}\right)_D = -0.5 \left(\frac{\partial H}{\partial B}\right)_A = -2 \left(\frac{\partial B}{\partial H}\right)_P = -1.309$$

compute the values of each of the following partial derivatives using conversion relationships if necessary:

$$\left(\frac{\partial A}{\partial B}\right)_H \quad \left(\frac{\partial A}{\partial H}\right)_B \quad \left(\frac{\partial A}{\partial B}\right)_D \quad \left(\frac{\partial A}{\partial H}\right)_P$$

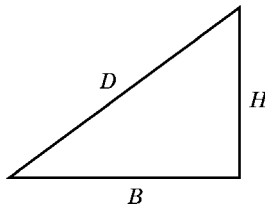


Figure 2.1. A right triangle.

b. Given the following different set of special conditions:

$$B = 4 \text{ cm}$$

$$\left(\frac{\partial H}{\partial A}\right)_P = -0.310 \left(\frac{\partial H}{\partial B}\right)_A = -2.0 \left(\frac{\partial P}{\partial B}\right)_A = 2.341$$

compute the values of each of the following partial derivatives using conversion relationships if necessary:

$$\left(\frac{\partial H}{\partial A}\right)_B \quad \left(\frac{\partial B}{\partial A}\right)_P \quad \left(\frac{\partial P}{\partial A}\right)_B$$

Compute A.

2.5. Considering  $U$  as a function of any two of the variables  $P$ ,  $V$ , and  $T$ , prove that

$$\left(\frac{\partial U}{\partial T}\right)_P \left(\frac{\partial T}{\partial P}\right)_V = - \left(\frac{\partial U}{\partial V}\right)_P \left(\frac{\partial V}{\partial P}\right)_T$$

2.6. Using the definition  $H = U + PV$  and, when necessary, obtaining conversion relationships by considering  $H$  (or  $U$ ) as a function of any two of the variables  $P$ ,  $V$ , and  $T$ , derive the following relationships:

$$\text{a. } \left(\frac{\partial H}{\partial T}\right)_P = \left(\frac{\partial U}{\partial T}\right)_V + \left[ P + \left(\frac{\partial U}{\partial V}\right)_T \right] \left(\frac{\partial V}{\partial T}\right)_P$$

$$\text{b. } \left(\frac{\partial H}{\partial T}\right)_P = \left(\frac{\partial U}{\partial T}\right)_V + \left[ V - \left(\frac{\partial H}{\partial P}\right)_T \right] \left(\frac{\partial P}{\partial T}\right)_V$$

$$\text{c. } \left(\frac{\partial U}{\partial T}\right)_V = \left(\frac{\partial H}{\partial T}\right)_P - \left[ \left(\frac{\partial H}{\partial T}\right)_P \left(\frac{\partial T}{\partial P}\right)_H + V \right] \left(\frac{\partial P}{\partial T}\right)_V$$

2.7. By a suitable experimental arrangement, it is possible to vary the total pressure  $P$  on a pure liquid independently of variations in the vapor pressure  $p$ . (However, the temperature of both phases must be identical if they are in equilibrium.) For such a system, the dependence of the vapor pressure on  $P$  and  $T$  is given by

$$\left(\frac{\partial \ln p}{\partial P}\right)_T = \frac{V_{\text{ml}}}{RT}$$

$$\left(\frac{\partial \ln p}{\partial T}\right)_P = \frac{\Delta H_{\text{m}}}{RT^2}$$



in which  $V_{\text{ml}}$  is the molar volume of liquid and  $\Delta H_{\text{m}}$  is the molar heat of vaporization. Prove that

$$\left(\frac{\partial P}{\partial T}\right)_P = -\frac{\Delta H_{\text{m}}}{TV_{\text{ml}}}$$

- 2.8. The length  $L$  of a wire is a function of the temperature  $T$  and the tension  $\tau$  on the wire. The linear expansivity  $\alpha$  is defined by

$$\alpha = \frac{1}{L} \left(\frac{\partial L}{\partial T}\right)_\tau$$

and is essentially constant in a small temperature range. Likewise, the isothermal Young's modulus  $Y$  defined by

$$Y = \frac{L}{A} \left(\frac{\partial \tau}{\partial L}\right)_T$$

in which  $A$  is the cross-sectional area of the wire is essentially constant in a small temperature range. Prove that

$$\left(\frac{\partial \tau}{\partial T}\right)_L = -\alpha AY$$

- 2.9. An ideal gas in State A (Fig. 2.2) is changed to State C. This transformation can be carried out by an infinite number of paths. However, only two paths will be considered, one along a straight line from A to C and the other from A to B to C [9].

- a. Calculate and compare the changes in volume from A to C that result from each of the two paths, AC and ABC. Proceed by integrating the differential Equation (2.2)

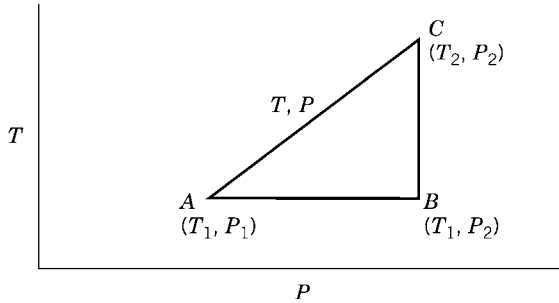
$$dV_{\text{m}} = \left(\frac{\partial V_{\text{m}}}{\partial P}\right)_T dP + \left(\frac{\partial V_{\text{m}}}{\partial T}\right)_P dT$$

or

$$dV_{\text{m}} = -\frac{RT}{P^2} dP + \frac{R}{P} dT$$

Before the integration is carried out along the path AC, use the following relationships to make the necessary substitutions:

$$\text{slope of line AC} = \frac{T_2 - T_1}{P_2 - P_1} = \frac{T - T_1}{P - P_1} \quad (2.47)$$



**Figure 2.2.** Two paths for carrying an ideal gas from State A to State C.

Therefore

$$T = T_1 + \frac{T_2 - T_1}{P_2 - P_1}(P - P_1) \quad (2.48)$$

and

$$dT = \frac{T_2 - T_1}{P_2 - P_1}dP \quad (2.49)$$

Remember that  $T_1$ ,  $T_2$ ,  $P_1$ , and  $P_2$  are constants in this problem.

- b. Applying the reciprocity test to Equation (2.6), show that  $dV_m$  is an exact differential.
- c. Calculate and compare the work performed in going from A to C by each of the two paths. Use the relationship

$$dW = -PdV_m = \frac{RT}{P}dP - RdT \quad (2.50)$$

and the substitution suggested by Equation (2.49).

- d. Applying the reciprocity test to Equation (2.50) show that  $dW$  is not an exact differential.
- 2.10.** For a wire, the change in length  $dL$  can be expressed by the following differential equation:

$$dL = \frac{L}{YA}d\tau + \alpha LdT$$

in which  $\tau$  is the tension and  $T$  is the temperature;  $A$  (cross-sectional area),  $Y$ , and  $\alpha$  are essentially constant if the extension is not large (see Exercise 8).

- a. Is  $dL$  an exact differential?
- b. Is the differential for the work of the stretching,  $dW = \tau dL$ , an exact differential?

- 2.11.** For an ideal gas we will show later that the molar entropy  $S_m$  is a function of the independent variables, molar volume  $V_m$  and temperature  $T$ . The total differential  $dS_m$  is given by the equation

$$dS_m = (C_{V_m}/T)dT + (R/V_m)dV_m$$

in which  $C_{V_m}$  and  $R$  are constants.

- Derive an expression for the change in volume of the gas as the temperature is changed at constant entropy, that is, for  $(\partial V_m/\partial T)_S$ . Your final answer should contain only independent variables and constants.
  - Is  $dS_m$  exact?
  - Derive an expression for  $(\partial C_{V_m}/\partial V_m)_T$ .
- 2.12.** The compressibility  $\beta$  and the coefficient of expansion  $\alpha$  are defined by the partial derivatives:

$$\beta = -\frac{1}{V} \left( \frac{\partial V}{\partial P} \right)_T$$

$$\alpha = \frac{1}{V} \left( \frac{\partial V}{\partial T} \right)_P$$

Show that

$$\left( \frac{\partial \alpha}{\partial P} \right)_T + \left( \frac{\partial \beta}{\partial T} \right)_P = 0$$

- 2.13.** For an elastic fiber such as a muscle fibril at constant temperature, the internal energy  $U$  is a function of three variables: the entropy  $S$ , the volume  $V$ , and the length  $L$ . With the aid of the laws of thermodynamics, it is possible to show that

$$dU = TdS - PdV + \tau dL$$

in which  $T$  is the absolute temperature,  $P$  is the pressure, and  $\tau$  is the tension on the elastic fiber. Prove the following relationships:

$$\left( \frac{\partial U}{\partial L} \right)_{S,V} = \tau - \left( \frac{\partial \tau}{\partial V} \right)_{S,L} = \left( \frac{\partial P}{\partial L} \right)_{S,V}$$

- 2.14.** The Gibbs function  $G$  is a thermodynamic property. If  $(\partial G/\partial T)_P = -S$  and  $(\partial G/\partial P)_T = V$ , prove the following relationship:

$$\left( \frac{\partial S}{\partial P} \right)_T = - \left( \frac{\partial V}{\partial T} \right)_P$$

- 2.15. The Helmholtz function  $A$  is a thermodynamic property. If  $(\partial A/\partial V)_T = -P$  and  $(\partial A/\partial T)_V = -S$ , prove the following relationship:

$$\left(\frac{\partial S}{\partial V}\right)_T = \left(\frac{\partial P}{\partial T}\right)_V$$

- 2.16. For a van der Waals gas

$$dU_m = C_{V_m}dT + \frac{a}{V_m^2}dV_m$$

in which  $a$  is independent of  $V_m$ .

- Can  $dU_m$  be integrated to obtain an explicit function for  $U_m$ ?
  - Derive an expression for  $(\partial C_{V_m}/\partial V_m)_T$ , which assumes that  $dU_m$  is exact.
- 2.17. Examine the following functions for homogeneity and degree of homogeneity:

a.  $u = x^2y + xy^2 + 3xyz$

b.  $u = \frac{x^3 + x^2y + y^3}{x^2 + xy + y^2}$

c.  $u = (x + y)^{1/2}$

d.  $e^{y/x}$

e.  $u = \frac{x^2 + 3xy + 2y^3}{y^2}$

## REFERENCES

- C. Caratheodory, *Math. Ann.* **67**, 355 (1909); P. Frank, *Thermodynamics*, Brown University Press, Providence, RI, 1945; J. T. Edsall and J. Wyman, *Biophysical Chemistry*, Vol. 1, Academic Press, New York, 1958; J. G. Kirkwood and I. Oppenheim, *Chemical Thermodynamics*, McGraw-Hill, New York, 1961; H. A. Buchdahl, *The Concepts of Classical Thermodynamics*, Cambridge University Press, Cambridge, UK, 1966; O. Redlich, *Rev. Mod. Phys.* **40**, 556 (1968); H. A. Buchdahl, *Am. J. Phys.*, **17**, 41 (1949); **17**, 212 (1949).
- R. C. Tolman, *Phys. Rev.* **9**, 237 (1917).
- P. J. Mohr and B. N. Taylor, *Rev. Mod. Phys.*, **77**, 1–107 (2005); <http://physics.nist.gov/constants>. [R. C. Tolman, *Phys. Rev.* **9**, 237 (1917), suggested that entropy replace temperature in the list of base units because  $S$  is an extensive quantity, and all the other base quantities are extensive. Ian Mills and colleagues recommended that the kilogram be defined rather than be based on a prototype mass, *Metrologia*, **42**, 71–80 (2005).]

4. IUPAC Compendium of Chemical Technology, 2nd ed., 1997. <http://www.iupac.org/goldbook/C00784.pdf>.
5. M. A. Paul, International Union of Pure and Applied Chemistry *Manual of Symbols and Terminology for Physicochemical Quantities and Units*, Butterworth London, 1975.
6. *Quantities, Units, and Symbols*, 2nd ed. A report of the Symbols Committee of the Royal Society, London, 1975; Chemical Society Specialist Periodical Reports, *Chemical Thermodynamics* Vol. 1, Chap. 2, 1971; I. Mills, T. Cvitas, K. Homann, N. Kallay, and K. Kuchitsu, eds., *Quantities, Units and Symbols in Physical Chemistry*, 2nd ed., Blackwell Science, Oxford, UK, 1993.
7. G. Thomas, M. D. Weir, J. Hass, and F. R. Giordano *Thomas' Calculus*, 11th ed., Pearson Education, Boston, 2004; J. Stewart, B. Pirtle, and K. Sandberg, *Multivariate Calculus: Early Transcendentals*, Brooks/Cole, Belmont, CA, 2003; R. Courant, *Differential and Integral Calculus*, 2nd ed., Blackie, Glasgow, Scotland, 1937.
8. For a conventional rigorous derivation in terms of limits, see H. Margenau and G. M. Murphy, *The Mathematics of Physics and Chemistry*, Van Nostrand, Princeton, NJ, 1st ed., 1943, pp. 6–8; 2nd ed., 1956, pp. 6–8. The approach of nonstandard analysis, however, provides a rigorous basis for the practice of treating a derivative as a ratio of infinitesimals. See A. Robinson, *Non-Standard Analysis*, North Holland, Amsterdam, The Netherlands, 1966, pp. 79–83, pp. 269–279.
9. We have demonstrated that Equation (2.24) is a necessary condition for exactness, which is adequate for our purposes. For a proof of mathematical sufficiency also, see A. J. Rutgers, *Physical Chemistry*, Interscience, New York, 1954, p. 177, or F. T. Wall, *Chemical Thermodynamics*, 3rd ed., W. H. Freeman, San Francisco, CA, 1974, p. 455.
10. Adapted from H. Margenau and G. M. Murphy, *Mathematics of Physics and Chemistry*, Van Nostrand, Princeton, NJ, 1943, pp. 8–11.

## CHAPTER 3

---

# THE FIRST LAW OF THERMODYNAMICS

---

Now that we have summarized the historical and mathematical background, the objectives, and the limitations of chemical thermodynamics, we will develop the basic postulates upon which its analytic framework is built. In discussing these fundamental postulates, which are essentially concise descriptions based on much experience, we will emphasize at all times their application to chemical, geological, and biological systems. However, first we must define a few of the basic concepts of thermodynamics.

### 3.1 DEFINITIONS

Critical studies of the logical foundations [1] of physical theory have emphasized the care that is necessary in defining fundamental concepts if contradictions between theory and observation are to be avoided. Our ultimate objective is clarity and precision in the description of the operations involved in measuring or recognizing the concepts. First let us consider a very simple example—a circle. At a primitive stage we might define a circle by the statement, “A circle is round.” Such a definition would be adequate for children in the early grades of elementary school, but it could lead to long and fruitless arguments as to whether particular closed curves are circles. A much more satisfactory and refined definition is “a group of points in a plane, all of which are the same distance from an interior reference point called the center.” This definition describes the operations that need to be carried out to generate a

---

*Chemical Thermodynamics: Basic Concepts and Methods, Seventh Edition.* Edited by Irving M. Klotz and Robert M. Rosenberg  
Copyright © 2008 John Wiley & Sons, Inc.

circle or to recognize one. The development of mature scientific insight involves, in part, the recognition that an early “intuitive understanding” at the primitive level often is not sound and sometimes may lead to contradictory conclusions from two apparently consistent sets of postulates and observations.

The operational approach to the definition of fundamental concepts in science has been emphasized by Mach, Poincare, and Einstein and has been expressed in a very clear form by Bridgman [2]. (Operational definitions had been used implicitly much earlier than the twentieth century. Boyle, for example, defined a chemical element in terms of the experiments by which it might be recognized, in order to avoid the futile discussions of his predecessors, who identified elements with qualities or properties.) In this approach, a concept is defined in terms of a set of experimental or mental operations used to measure or to recognize the quantity: “The concept is synonymous with the corresponding set of operations” (Bridgman). An operational definition frequently may fail to satisfy us that we know what the concept *really is*. The question of scientific *reality* has been explored by many scientists and philosophers and is one that every student should examine. However, in the operational approach, we are not concerned with whether our definition has told us what the concept *really is*; what we need to know is *how to measure it*. The operational approach has been stated succinctly by Poincare in the course of a discussion of the concept of force:

When we say force is the cause of motion we talk metaphysics, and this definition, if we were content with it, would be absolutely sterile. For a definition to be of any use, it must teach us to measure force. Moreover that suffices; it is not at all necessary that it teach what force is in itself nor whether it is the cause or the effect of motion.

The power of the operational approach became strikingly evident in Einstein’s theory of special relativity, with its analysis of the meaning of presumably absolute, intuitive concepts such as time or space. Newton defined absolute time as

Absolute, True, and Mathematical Time, of itself, and from its own nature flows equably without regard to anything external.

The difficulty with a definition of this type, based on properties or attributes, is that we have no assurance that anything of the given description actually exists in nature. Thus, Newton’s definition of time implies that it would be clear and meaningful to speak of two events in widely separated places (for example, the flaring up of two novae) as occurring simultaneously; presumably each event occurs at the same point on the time scale, which flows equably without regard to external events or to the activities of the individuals making the observations. In contrast, in relativity theory, time is defined by a description of specific manipulations with clocks, light signals, and measuring rods. It turns out that events that are simultaneous for one observer will occur at different moments if viewed by another observer moving at a different velocity. Which observer is *correct*? In practice this question is meaningless. Both are correct. In fact, no operational meaning exists to *absolute simultaneity*, despite its intuitive reasonableness. All operations by which time is measured are relative ones. Thus, the term *absolute time* becomes meaningless.

Relativity theory, with its rigorous operational definitions of time and space, led to many unexpected results that are contrary to common experience. One result was that the measured length of a body depends on the speed with which the body moves with respect to the observer. These new theorems from relativity theory removed apparent contradictions that had perplexed physicists in their measurements of the speed of light, and they also allowed prediction of a variety of new phenomena that since have been verified abundantly.

Thus, physical scientists have become increasingly aware of the need to define concepts in terms of operations instead of relying on intuitive feelings of *a priori* recognition. To avoid possible pitfalls in thermodynamic applications, it is desirable that all thermal and energy concepts likewise be approached with an operational attitude. The use of operational definitions is particularly important in a phenomenological science such as thermodynamics.

Before approaching these thermodynamic concepts, we need to agree on the meaning of certain more primitive terms that will occur often in our analyses. We shall assume without analysis that the term *body* as an identifiable, definite thing has an obvious meaning. When we carry out experiments on or make observations of a body in order to characterize it, we obtain information that we call the *properties* of the body. Similarly, we shall speak of the properties of a *system*, which is any region of the universe, large or small, that is being considered in our analysis. Regions outside the boundaries of the system constitute the *surroundings*. A system is said to be in a certain *state* when all of its properties have specified values. The values of these properties are called *variables of state*. Generally, only a few properties of a system in a given state can be expressed as independent variables. It has been found, empirically, that only *two* intensive variables need to be specified to determine the values of all other intensive variables and hence the state of a one component system. Relationships between dependent variables of state and independent variables of state are specified by *equations of state*. If one or more properties of a system are found to be different at two different times, then in this time interval, a *process* has taken place and a *change of state* has occurred. We also will speak of a *closed system*, by which we mean a system that mass neither enters nor leaves. Obviously then, an *open system* is one that mass may enter or leave. An *adiabatic system* is a closed system in which, if it is in thermal equilibrium, no change in state can be produced except by movement of its boundaries. In essence, work must be done on an adiabatic system if its state is to be changed; if only *PV* work is done, the boundaries must be moved. (If electrically charged bodies are present in the system, this definition of “adiabatic” is inadequate, but such situations will not be considered here.) Such a system also is described as *thermally insulated* from the surroundings. With these primitive notions, we will proceed to an analysis of thermodynamic concepts.

## Temperature

The earliest concept of temperature undoubtedly was physiologic, that is, based on the sensations of heat and cold. Such an approach necessarily is very crude in both precision and accuracy. In time, people observed that the same temperature



changes that produced physiologic responses in themselves also produced changes in the measurable properties of matter. Among these properties are the volume of a liquid, the electrical resistance of a metal, the resonance frequency of a quartz crystal, and the volume of a gas at constant pressure.

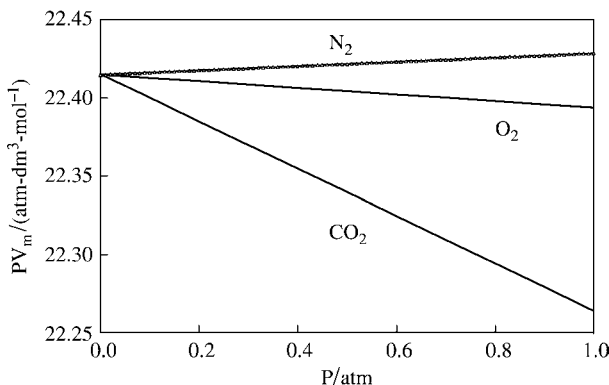
Each of these properties can provide the basis for an operational definition of a temperature scale. For example, the Celsius temperature  $\Theta$  is defined by Equation (3.1):

$$\theta = \frac{X_{\theta} - X_0}{X_{100} - X_0}(100) \quad (3.1)$$

in which  $X_{\theta}$  is the value of the property at temperature  $\Theta$ ,  $X_0$  is the value of the property at the temperature of a mixture of ice and water at equilibrium under a pressure of 1 atm ( $1.0135 \times 10^5$  Pa), and  $X_{100}$  is the value of the property at the temperature of an equilibrium mixture of water and steam under a pressure of 1 atm.

Unfortunately, when temperatures other than  $0^{\circ}\text{C}$  and  $100^{\circ}\text{C}$  are measured, the value obtained depends on the property used to measure it and, for the same property, depends on the substance whose property is measured. However, when the product of the pressure and the molar volume of a gas A, which is a quantity that changes in a monotonic fashion with changes of temperature, is measured at a series of pressures, and these values are extrapolated to a limit at zero pressure, the limit is the same for all gases at a given temperature. This phenomenon is illustrated for several gases in Figure 3.1.

The result shown in Figure 3.1 lends confidence in the use of the properties of gases at the limit of zero pressure as a fundamental basis for a temperature scale. It also is found that the limit of the pressure-volume product at zero pressure



**Figure 3.1.** Pressure-volume product data for several gases at low pressures at  $0^{\circ}\text{C}$ . Data for oxygen and nitrogen from G. Baxter and H. Starkweather, *Proc. Natl. Acad. Sci. U. S. A.* **12**, 699 (1926); **14**, 50 (1928); data for carbon dioxide from E. B. Millard, *Physical Chemistry for Colleges*, McGraw-Hill, New York, 1946, p. 15.

extrapolates to zero at a sufficiently low temperature. This behavior leads to a definition of an absolute ideal gas temperature scale, which is denoted by  $T$ .

Following an international convention [3], if we take the temperature of the triple point of water as a reference temperature ( $T_0$ ) and assign it the value of 273.16 K on the absolute scale, then any other ideal gas temperature  $T$  is defined by the equation

$$\frac{T}{T_0} = \frac{\lim_{P \rightarrow 0} (PV)_T}{\lim_{P \rightarrow 0} (PV)_{T_0}} = \frac{T}{273.16 \text{ K}} \quad (3.2)$$

Difficulties develop if the thermometer is exposed to certain types of radiation. However, calculations indicate that under normal circumstances, these radiation fields raise the temperature by only about  $10^{-12}^\circ\text{C}$ , which is a quantity that is not detectable even with the most sensitive current-day instruments [4]. Similarly, we shall neglect relativistic corrections that develop at high velocities, for we do not encounter such situations in ordinary thermodynamic problems.

Although the ideal gas temperature scale provides an adequate basis for a temperature scale that is independent of the working substance, it is difficult to do actual temperature measurements using it. Practical temperature scales are defined in terms of fixed points, interpolating instruments, and equations that relate the measurement of a particular instrument to the temperature. The most recent practical temperature scale, the *International Temperature Scale of 1990* (ITS-90), improves on earlier such scales by including reference temperatures between 0.5 K and 13.8 K and by replacing less-reproducible thermocouple measurements by measurements with a platinum resistance thermometer in the range between 630 K and 1064 K. The scale is designed to reproduce ideal gas temperatures with an uncertainty less than the uncertainty of the ideal gas scale itself [5].

The word “thermodynamics” implies a relationship between thermal properties, such as temperature, and the dynamic properties described by classic mechanics. Therefore, we shall consider next the dynamic concepts of work and energy and relate them to the properties of thermodynamic systems.

## Work

For our purposes, work is done when a displacement occurs under the influence of a force; the amount of work is taken as the product of a force by the displacement. Because force and displacement can be given suitable operational significance, the term “work” also will share this characteristic. The measurement of the displacement involves experimental determinations of a distance, which can be carried out, in principle, with a measuring rod. The concept of force is somewhat more complicated. It undoubtedly originated from the muscular sensation of resistance to external objects. A quantitative measurement is obtained readily with an elastic body, such as a spring, whose deformation can be used as a measure of the force. However, this definition of force is limited to static systems. For systems that are being accelerated, additional refinements must be considered. Because these considerations would take us far

from our main course, we merely make reference to Bridgman's critical analysis [2]. Nevertheless, for the definition of force even in the static situation, it should be emphasized that precision measurements require several precautions, particularly against changes in temperature. In dealing with these concepts, we generally assume implicitly that such sources of error have been recognized and accounted for.

A body or system can do work on its surroundings, or the surroundings can do work on the system. Therefore, we must agree on a sign convention for work  $W$ . We will follow the convention that  $W$  represents the work done *on* a system by its surroundings. Therefore, a negative value for  $W$  signifies that the system has done work on its surroundings; a positive value signifies that work has been done on the system by some agency in the surroundings.

As the concept "work" focuses on an interaction of the system with its surroundings, we shall define work in terms of the external force  $\mathbf{F}'$ , rather than  $\mathbf{F}$ , the force exerted by the system. For example, let us consider a spring subject to an external force  $\mathbf{F}'$ , where the restoring force of the spring is  $\mathbf{F}$ . Mathematically, work is defined as the line integral of the scalar product of the external force vector  $\mathbf{F}'$  and an infinitesimal displacement vector  $d\mathbf{s}$ , in this case the change in length of the spring. If  $\mathbf{F}'$  is greater than  $\mathbf{F}$ , then the displacement is in the direction of the external force; if  $\mathbf{F}'$  is less than  $\mathbf{F}$ , then the displacement is in the direction opposite to the external force. The symbolic statement of the definition is

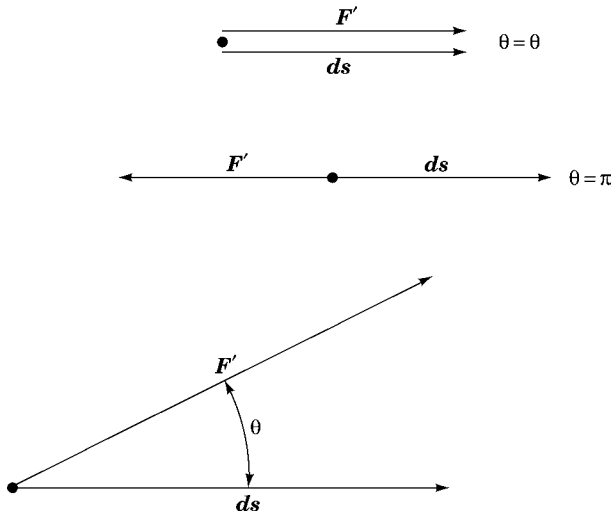
$$\begin{aligned} W &= \int_{\text{path}} \mathbf{F}' \cdot d\mathbf{s} \\ &= \int_{\text{path}} |\mathbf{F}'| |d\mathbf{s}| \cos \theta \end{aligned} \quad (3.3)$$

The vertical lines indicate the magnitude of the force vector and of the displacement vector, and  $\theta$  is the angle between the force vector and the displacement vector, as illustrated in Figure 3.2.

The sign convention for work  $W$  follows naturally from the definition in Equation (3.3). When the external force vector is in the same direction as the displacement vector, the surroundings do work on the system,  $\theta$  is equal to 0,  $\cos \theta$  is equal to 1, and  $W$  is positive. When the external force vector is in the opposite direction from that of the displacement vector, the system does work on the surroundings,  $\theta$  is equal to  $\pi$ ,  $\cos \theta$  is equal to  $-1$ , and  $W$  is negative. Thus, the convention that  $W$  represents the work done on the system by its surroundings follows naturally from the definition of work.<sup>2</sup>

Figure 3.3 is a schematic representation for the work done by an external force  $\mathbf{F}'$  in the interaction of a gas in a cylinder with its surroundings.  $|\mathbf{F}'|$  is the magnitude of the force exerted by the surroundings on the boundary of the system,  $|\mathbf{F}|$  is the magnitude of the force exerted by the gas on the boundary, and  $|d\mathbf{s}|$  is the magnitude of the element of displacement of the boundary. The sign of the work is consistent

<sup>2</sup>The opposite sign convention for work appears if we put a minus sign in Equation (3.3). Such a convention was formerly common in thermodynamics.

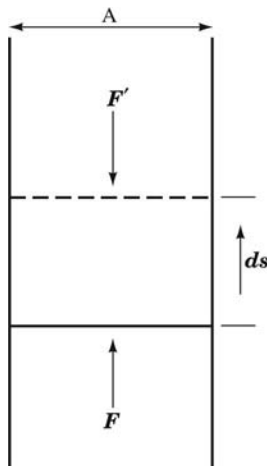


**Figure 3.2.** Possible relationships between the vector of external force  $F'$  and the displacement vector  $ds$ .

with the chosen convention if the infinitesimal element of work is defined as in Equation (3.4):

$$DW = |F'| |ds| \cos \theta \quad (3.4)$$

where the external force is in the direction shown in Figure 3.3. If the gas is compressed,  $ds$  is in the same direction as  $F'$  and the work is positive, because  $\cos \theta = 1$ . Conversely, if the gas expands,  $ds$  is in the opposite direction from  $F'$



**Figure 3.3.** Element of work.

and the work is negative, because  $\cos \theta = -1$ . The definition states explicitly that the amount of work done is determined by the *external force*, not the by the *internal force*.

In a noninfinitesimal change of state, the work done is obtained by integrating Equation (3.4) from a lower limit, the initial state, State 1, to an upper limit, the final state, State 2. That is,

$$W = \int_{\text{State 1}}^{\text{State 2}} |\mathbf{F}'| |d\mathbf{s}| \cos \theta \quad (3.5)$$

In accord with the definition of work in Equation (3.5), the path over which the change of state occurs must be known; that is,  $|\mathbf{F}'|$  must be known as a function of the displacement  $s$ .

For example, if the bottom of Figure 3.3 represents a cylinder of gas that exerts a force  $\mathbf{F}$  on the walls, then  $\mathbf{F}'$  represents the external force on the piston in the cylinder (for example, that caused by a weight). As the magnitude of the external force  $|\mathbf{F}'| = P'A$ , where  $P'$  is the external pressure and  $A$  is the area of the piston, we can write Equation (3.5) as

$$W = \int_{\text{State 1}}^{\text{State 2}} P'A |ds| \cos \theta = \int_{V_1}^{V_2} P' |dV| \cos \theta$$

For gaseous expansion,  $\cos \theta = -1$  and  $|dV| = dV$ ; for gaseous compression,  $\cos \theta = 1$ , and  $|dV| = -dV$ , so that for both expansion and compression,

$$W = - \int_{V_1}^{V_2} P' dV$$

and

$$dW = -P' dV \quad (3.6)$$

A special case of gaseous expansion, and one that can only be approached but not exactly realized, is that in which the external pressure is adjusted continuously so that it differs only infinitesimally from the pressure of the gas. By an infinitesimal change in the external pressure, the direction can be reversed, hence, the designation *reversible*.

If the change of state is carried out reversibly, so that  $P'$  is not significantly different from  $P$  throughout the change of state, then Equation (3.6) can be changed to

$$W = - \int_{V_1}^{V_2} P dV \quad (3.7)$$

If work is done on the system, the gas is compressed,  $V_2$  is less than  $V_1$ , and  $W$  is positive, which is consistent with the chosen convention. If work is done by the system, the gas expands,  $V_2$  is greater than  $V_1$ , and  $W$  is negative. In practice, to

evaluate the integral analytically,  $P$  must be known as a function of  $V$ , for example, from an equation of state.

Let us also consider the reversible work done when a spring changes in length by an amount  $dL$ . If the extension from the rest length  $L_0$  is not too great, the tension  $\tau$  in the spring is given by Hooke's law as

$$\tau = -k(L - L_0) \quad (3.8)$$

We can maintain the sign convention that we have chosen for  $W$  if we define  $DW$  as

$$DW = -\tau dL = k(L - L_0) dL \quad (3.9)$$

If the original length of the spring is greater than its rest length, the surroundings must do work on the spring for the length to be increased even more, because  $L - L_0$  is positive and  $dL$  is also positive. If the original length of the spring is less than its rest length, the spring must do work on the surroundings for the length to be increased even more, because  $L - L_0$  is negative and  $dL$  is still positive. Other possible combinations of length and direction also yield the correct sign of  $dW$ .

Similarly, if we focus attention on the reversible work in raising a body a certain height,  $dh$ , against the force of gravity, we write

$$DW = mgdh \quad (3.10)$$

in which  $m$  is the mass of the body and  $g$  is the gravitational acceleration. In this case, some force other than the gravitational force does work on the body in raising it in the gravitational field, and  $W$  is positive if  $dh$  is positive. If the body falls in the gravitational field,  $dh$  is negative, the body can do work, and  $W$  is negative.

From these examples, equations for other types of work should follow naturally.

## 3.2 THE FIRST LAW OF THERMODYNAMICS

### Energy

In its modern form, the first law of thermodynamics has its empirical basis in a series of experiments conducted by Joule between 1843 and 1848. He used a system surrounded by *adiabatic* walls, which do not allow the system to be affected by temperature differences between the system and the surroundings. He did work on such an adiabatic system in a variety of ways, using the rotation of a paddle wheel, the passage of an electric current, friction, and the compression of a gas. He concluded that a given amount of work done on the system, no matter how it was done, produced the same change of state, as measured by the change in the temperature of the system. Thus, to produce a given change of state, the *adiabatic work* required is *independent of the path* by which the change is achieved.

Therefore, it seems appropriate to define a quantity, the energy  $U$ , whose value is characteristic of the state of a system, whereby the adiabatic work required to bring about a change of state is equal to the difference between the value of  $U$  in one state and that in another state. That is,

$$\Delta U = U_2 - U_1 = W_{\text{adiabatic}} \quad (3.11)$$

The sign is consistent with our convention for work; if the system does work on the environment, the energy of the system must decrease, and vice versa. This formulation of the definitions of adiabatic systems and of energy and the subsequent discussion of the first law originated with Caratheodory [6].

## Heat<sup>1</sup>

It is well known that the changes of state brought about by adiabatic work also can be brought about without doing work. A change can be achieved without expenditure of work by placing a system in contact with another system at a different temperature through rigid, nonadiabatic (or thermally conducting) walls. It is this exchange of energy, which is a result of a temperature difference, that we call *heat* ( $Q$ ). As the energy difference has been determined in previous experiments by measuring the adiabatic work, the amount of heat transferred can be measured by the change in energy in a system on which no work is done. That is,

$$Q = \Delta U \text{ (no work)} = (U_2 - U_1) \text{ (no work)} \quad (3.12)$$

The positive sign in Equation (3.12) expresses the convention that  $Q$  is positive when heat is transferred from the surroundings to the system. Such a transfer results in an increase in the energy of the system.

## General Form of the First Law

Let us consider the general case in which a change of state is brought about both by work and by transfer of heat. It is convenient to think of the system as being in thermal contact with a body that acts as a heat bath (one that transfers heat but does no work) as well as in non-thermal contact with another portion of the environment, so that work can be done.

The value of  $\Delta U$  in the change of state can be determined from the initial and final states of the system as well as from a comparison with previous experiments that used only adiabatic work. The work  $W$  can be calculated from the changes in the environment (for example, from the change in position of a weight). The value of  $Q$  is determined from the change of state of the heat bath, which was also previously calibrated by experiments with adiabatic work.

<sup>1</sup>Alternate views can be found in Reference 7.

Although the change in state of the heat bath, hence the value of  $Q$ , usually is determined by measuring a change in temperature, this is a matter of convenience and custom. For a pure substance the state of a system is determined by specifying the values of two intensive variables. For a heat bath whose volume (and density) is fixed, the temperature is a convenient second variable. A measurement of the pressure, viscosity, or surface tension would determine the state of the system equally as well. This point is important to the logic of our development because a later definition of a temperature scale is based on heat measurements. To avoid circularity, the measurement of heat must be independent of the measurement of temperature.

Although the proportions of the energy change contributed by heat and by work can vary from one extreme to the other, the sum of the heat effect and the work effect is always equal to  $\Delta U$  for a given change of state, as indicated in Equation (3.13).

$$\Delta U = Q + W \quad (3.13)$$

That is,  $Q$  and  $W$  can vary for a given change of state, depending on how the change is carried out, but the quantity  $(Q + W)$  is always equal to  $\Delta U$ , which depends only on the initial and final states.

The energy  $U$  is called a *state function*. It is appropriate to use a quantity  $\Delta U$  equal to the difference between the values of  $U$  in two different states. The quantities  $Q$  and  $W$  are not expressed as differences because their values depend on the path taken from one state to another.

For an infinitesimal change of state, the analog of Equation (3.13) is

$$dU = DQ + DW \quad (3.14)$$

in which the difference in notation indicates that  $dU$  is a differential of a function, which is an *exact differential*, whereas  $DQ$  and  $DW$  are *inexact differentials*. Another way to express the difference is to say that the integral of  $dU$  around a closed path is equal to zero:

$$\oint dU = 0 \quad (3.15)$$

whereas the integrals of  $DQ$  and  $DW$  around a closed path can have any value, depending on the path taken. Equation (3.15) is thus a statement of the conservation of energy.<sup>3</sup>

It also should be pointed out that the very definition of the energy concept precludes the possibility of determining absolute values thermodynamically; that is, we have defined only a method of measuring *changes* in internal energy. In this regard, a significant difference exists between the character of the thermodynamic property energy and that of a property such as volume. We can specify an

<sup>3</sup>Some readers may prefer Joule's statement: "it is manifestly absurd to suppose that the power with which God has endowed matter can be destroyed any more than that they can be created by man's agency." J. P. Joule, *Scientific Papers*, Vol I, reprinted by Dawsons of Pallmall, London, 1963, p. 269.



unambiguous value for the volume of a system in a particular state. However, it is appropriate to speak of “energy” only with reference to a transition from one configuration of a system to another, that is, only with reference to an energy change. No measurement of the energy of a given state can occur. Energy differences can be measured, and a value can be assigned to a particular state in terms of an arbitrary reference state. To speak of energy in an absolute sense is only a way of expressing the observation that certain aspects of a transition depend uniquely on characteristics of the initial and final states.

Equations (3.11)–(3.13) (repeated here), together with the statement that  $U$  is a state function, constitute a complete statement of the first law. In effect, Equations (3.11) and (3.12) are operational definitions of  $\Delta U$  and  $Q$ , respectively, whereas Equation (3.13) is an empirical statement of the relationship among the quantities  $\Delta U$ ,  $Q$ , and  $W$ :

$$\Delta U = U_2 - U_1 = W_{\text{adiabatic}} \quad (3.11)$$

$$Q = \Delta U \text{ (no work)} = (U_2 - U_1) \text{ (no work)} \quad (3.12)$$

$$\Delta U = Q + W \quad (3.13)$$

## EXERCISES

- 3.1.** If the temperature of 1 mL of air at 1 atm and  $0^\circ\text{C}$  is raised to  $100^\circ\text{C}$  at the same pressure, the volume becomes 1.3671 mL. Calculate the value of absolute zero for a thermometer using air, assuming that the pressure-volume product is linear with absolute temperature even at 1 atm. Compare your result with the ice-point temperature in Table 2.3.
- 3.2.** Let Figure 3.3 represent a plane surface (such as a soap film between wires) that is being expanded in the direction indicated. (The symbol  $A$  must be replaced by a symbol  $L$  for the length of the wire, with  $A$  being the area of the surface.) Show that the work of reversible expansion is given by the expression

$$W = \int \gamma dA$$

in which  $\gamma$  is the force per unit length of the leading edge of the soap film and  $A$  is the surface area.

- 3.3.** Let  $\tau$  represent the tension of a wire of length  $L$ ,  $A$  represent its cross-sectional area, and  $Y$  represent the isothermal Young’s modulus  $(L/A)(\partial\tau/\partial L)_T$ . For a wire,  $A$  and  $Y$  are essentially constant as the tension is increased, and  $L$  changes very little with changing tension. (See Exercises 2.8 and 2.10.) Show that the work for an isothermal reversible increase in tension of a wire is

given by

$$W = \frac{L}{2AY} (\tau_{\text{final}}^2 - \tau_{\text{initial}}^2)$$

- 3.4. From Equation (3.13), show that  $DQ$  is an exact differential for a process at constant pressure in which only  $PV$  work is performed.
- 3.5. If the atmosphere were isothermal, the pressure would vary with height according to the equation

$$P = P_0 e^{-\frac{Mgh}{RT}}$$

where  $P_0$  ( $1.01325 \times 10^5$  Pa) is the pressure at sea level,  $M$  is the average molar mass of air (considered to be 80 mol%  $N_2$  and 20 mol%  $O_2$ ),  $g$  is the acceleration from gravity,  $h$  is the height,  $R$  is the gas constant and  $T$  is the ideal gas temperature. If a rigid balloon containing  $100 \times 10^3 \text{ dm}^3$  of helium and carrying a load of 100 kg is allowed to float in an atmosphere at 298 K, at what height will it come to rest? What will be its potential energy?

## REFERENCES

1. H. Poincare, *Science and Hypothesis*, reprinted by Dover, New York, 1952; P. W. Bridgman, *The Logic of Modern Physics*, Macmillan, New York, 1927; P. W. Bridgman, *The Nature of Thermodynamics*, Harvard University Press, Cambridge, MA, 1941; P. Duhem, *The Aim and Structure of Physical Theory*, Princeton University Press, Princeton, NJ, 1954.
2. Bridgman, *Logic of Modern Physics*.
3. M. A. Paul, International union of pure and applied chemistry, *Manual of Symbols and Terminology for Physicochemical Quantities and Units*, Butterworth, London, 1975. B. N. Taylor, ed., *The International System of Units*, 7th ed., NIST Special Publication 330 (2001), <http://physlab.nist.gov/Pubs/SPS330/sps330.html>.
4. Bridgman, *Nature of Thermodynamics*.
5. J. B. Ott and J. R. Goates, Temperature measurement with application to phase equilibria studies, in *Physical Methods of Chemistry*, 2nd ed., Vol. VI, *Determination of Thermodynamic Properties*, B. W. Rossiter and R. C. Baetzold, eds., Wiley-Interscience, New York, 1992; B. W. Mangum, *J. Res. Natl. Inst. Stand. Technol.* **95**, 69 (1990); H. Preston-Thomas, *Metrologia* **27**, 3 (1990); M. L. McGlashan, *J. Chem. Thermodynamics* **22**, 653 (1990).
6. C. Caratheodory, *Math. Ann.* **67**, 355 (1909); O. Redlich, *Rev. Mod. Phys.*, **40**, 556 (1968); H. A. Buchdahl, *Am. J. Physics*. **17**, 41, 212 (1949).
7. H. B. Callen, *Thermodynamics*, John Wiley & Sons, Inc., New York, 1959, pp. 15–20; K. Denbigh, *Principles of Chemical Equilibrium*, 3rd ed., Cambridge University Press, Cambridge, 1971, pp. 15–19; M. W. Zemansky and R. H. Dittman, Heat and Thermodynamics; N. C. Craig, *J. Chem. Educ.*, **79**, 193–200 (2002).



## CHAPTER 4

---

# ENTHALPY, ENTHALPY OF REACTION, AND HEAT CAPACITY

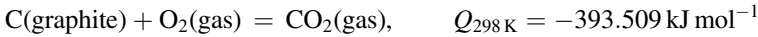
---

In Chapter 3, we defined a new function, the internal energy  $U$ , and noted that it is a thermodynamic property; that is,  $dU$  is an exact differential. As  $Q$  was defined in Equation (3.12) as equal to  $\Delta U$  when no work is done, the heat exchanged in a constant-volume process in which only  $PdV$  work is done is also independent of the path. For example, in a given chemical reaction carried out in a closed vessel of fixed volume, the heat absorbed (or evolved) depends only on the nature and condition of the initial reactants and of the final products; it does not depend on the mechanism by which the reaction occurs. Therefore, if a catalyst speeds up the reaction by changing the mechanism, it does not affect the heat exchange accompanying the reaction.

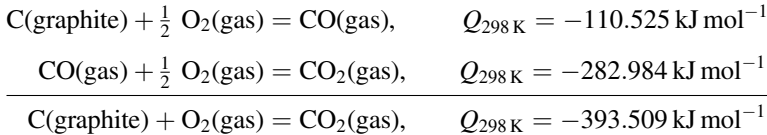
Most chemical reactions are carried out at constant (atmospheric) pressure rather than at constant volume. It is of interest to know then whether the heat absorbed in a constant-pressure reaction depends on the path—that is, on the method by which the reaction is carried out—or whether it too is a function only of the initial and final states. If the latter were true, it would be possible to tabulate heat quantities for given chemical reactions and to use known values to calculate heats for new reactions that can be expressed as sums of known reactions.

Actually, this question was answered on empirical grounds long before thermodynamics was established on a sound basis. In courses in elementary chemistry, students become familiar with Hess's law of constant heat summation, which was enunciated in 1840. Hess pointed out that the heat absorbed (or evolved) in a

given chemical reaction is the same whether the process occurs in one step or in several steps. Thus, to cite a familiar example, the heat of formation [1] of  $\text{CO}_2$  from its elements is the same if the process is the single step



or the series of steps



It is difficult to measure the heat of combustion of graphite to carbon monoxide because carbon dioxide always is produced as well. But, from Hess's law, it is possible to calculate the heat of combustion of graphite to carbon monoxide from the more easily measurable heats of combustion of graphite and of carbon monoxide to carbon dioxide.

We could introduce Hess's generalization into thermodynamics as another empirical law, which is similar to the first law. However, a firm theoretical framework depends on a minimum of empirical postulates. Thermodynamics is so powerful a method precisely because it leads to so many predictions from only two or three basic assumptions. Hess's law need not be among these postulates, because it can be derived directly from the first law of thermodynamics perhaps most conveniently by using a new thermodynamic function, *enthalpy*.

## 4.1 ENTHALPY

### Definition

Let us start by considering the quantity of heat  $DQ_P$  that is exchanged in a process at constant pressure when only  $PV$  work is performed. From the first law,

$$DQ = dU - DW$$

and, because only  $PV$  work is performed, and the pressure is equal to the constant pressure of the surroundings,

$$DW = -PdV$$

Then

$$DQ_P = dU + PdV \quad (4.1)$$

As the pressure is constant, we can add  $VdP$  to the right side of Equation (4.1) without changing the equality. The result is

$$\begin{aligned}DQ_P &= dU + PdV + VdP \\ &= dU + d(PV) \\ &= d(U + PV)\end{aligned}\tag{4.2}$$

Thus, the heat exchanged at constant pressure when only  $PV$  work is performed is the differential of a state function,  $U + PV$ . Therefore, it is useful to define a new state function, the enthalpy  $H$  as

$$H = U + PV\tag{4.3}$$

From the definition,<sup>1</sup> it is evident that  $H$ , the enthalpy, is a thermodynamic property because it is defined by an explicit function. All quantities on the right side of Equation (4.3),  $U$ ,  $P$ , and  $V$ , are properties of the state of a system; consequently, so is  $H$ . Then we can rewrite Equation (4.2) as

$$DQ_P = dH_P = dQ_P\tag{4.4}$$

It is also evident from the definition [Equation (4.3)] that absolute values of  $H$  are unknown because absolute values of  $U$  cannot be obtained from classic thermodynamics alone. Therefore, from an operational point of view, it is possible only to consider *changes* in enthalpy  $\Delta H$ . Such changes can be defined readily by the expression

$$\Delta H = \Delta U + \Delta(PV)\tag{4.5}$$

and

$$\Delta H_P = Q_P\tag{4.6}$$

in which the subscript emphasizes the restriction of constant pressure during the process. Equations (4.5) and (4.6) are valid *only* if no *nonmechanical* work is being performed. Under these conditions,  $dQ$  is an exact differential. In other words, for chemical reactions carried out at constant pressure (for example, at atmospheric pressure) in the usual laboratory or large-scale vessels, the heat absorbed depends only on the nature and conditions of the initial reactants and of the final products. Thus, it does not matter whether a given substance is formed in one step or in many steps. As long as the starting and final materials are the same, and as long as the processes are carried out at constant pressure and with no nonmechanical work, the net  $Q$ 's will be the same. Thus, Hess's law is a consequence of the first law of thermodynamics.

<sup>1</sup>This definition is an example of a Legendre transform, as discussed by some authors, such as R. A. Alberty, *Pure Appl. Chem.* **73**, 1349 (2001).

**Relationship between  $Q_V$  and  $Q_P$** 

We have just proved that  $\Delta H$  equals  $Q_P$  for a reaction at constant pressure. Although most calorimetric work is carried out at a constant pressure, some reactions must be observed in a closed vessel, that is, at constant volume. In such a closed system, the heat quantity that is measured is  $Q_V$ . For additional chemical calculations, it frequently is necessary to know  $Q_P$ . Therefore, it is highly desirable to derive some expression that relates these two heat quantities.

We will use the relationship implied in Equation (3.12),

$$\Delta U_V = Q_V \quad (4.7)$$

and in Equation (4.6),

$$\Delta H_P = Q_P$$

together with Equation (4.5) restricted to a constant-pressure process:

$$\Delta H_P = \Delta U_P + P \Delta V \quad (4.8)$$

where  $P$  is the pressure of the constant pressure process. Generally,  $\Delta U_P$  is not significantly different from  $\Delta U_V$ . In fact, for ideal gases at a fixed temperature (as we will see in Chapter 5),  $U$  is independent of the volume or pressure. Hence, as a rule,

$$\Delta U_P \cong \Delta U_V = Q_V \quad (4.9)$$

Substituting Equations (4.6) and (4.9) into (4.8), we obtain

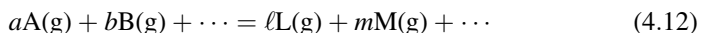
$$Q_P = Q_V + P \Delta V \quad (4.10)$$

(where  $Q_P$  and  $Q_V$  refer to different changes of state).

In reactions involving only liquids and solids, the  $P\Delta V$  term usually is negligible in comparison with  $Q$ ; hence, the difference between  $Q_P$  and  $Q_V$  is slight. However, in reactions involving gases,  $P\Delta V$  may be significant because the changes in volume may be large. Generally, this term can be estimated with sufficient accuracy by using the equation of state for ideal gases,

$$PV = nRT \quad (4.11)$$

in which  $n$  represents the number of moles of a particular gas. If the chemical reaction is represented by the expression



in which  $a$ ,  $b$ ,  $\ell$ , and  $m$  indicate the number of moles of each gas, then, because an isothermal change is being considered,

$$Q_P = Q_V + P\Delta V = Q_V + (\ell RT + mRT + \cdots - aRT - bRT - \cdots)$$

or

$$Q_P = Q_V + (\Delta n)RT \quad (4.13)$$

The symbol  $\Delta n$  refers to the change in number of moles *of gases only* when one mole of reaction occurs. In common reactions  $(\Delta n)RT$  contributes a few kilojoules to the difference  $Q_P - Q_V$  (see Exercise 4.1 at the end of this chapter).

## 4.2 ENTHALPY OF REACTIONS

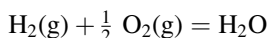
In Section 4.1, we introduced a new function—enthalpy—and found among its properties a correspondence with the heat of reaction at constant pressure (when the only work is from a volume change against that pressure). Most chemical reactions are carried out in a vessel exposed to the atmosphere and under conditions such that no work other than that against the atmosphere is produced. For this reason, and because  $\Delta H$  is independent of the path of a reaction and is measured by the heat transferred in the reaction, the enthalpy change of a reaction is a useful quantity. Knowledge of the heat of reaction is particularly important when one needs to plan the heating or cooling required to maintain an industrial chemical reaction at constant temperature.

Enthalpy changes also give pertinent information for several other problems in chemical thermodynamics. For a long time it was thought that a negative sign of  $\Delta H$ , which is characteristic of a reaction in which heat is evolved, is a criterion for a spontaneous reaction. When this misconception was cleared up, it was evident that this criterion is still useful within certain limitations. If the  $\Delta H$  values are large enough, their signs still can be used as the basis for a first guess regarding the spontaneity of a reaction. In more rigorous applications, the entropy change must be known in addition to the enthalpy change (see Chapter 6).

Also,  $\Delta H$  values are required to calculate the temperature dependence of equilibrium constants. For all these reasons, it is desirable to have tables of  $\Delta H$  values available, so that the enthalpies of various transformations can be calculated readily. In many of these calculations, we make use of Hess's law, which is now firmly established on the basis of the first law of thermodynamics. We can then calculate  $\Delta H$  for reactions for which the heat effect is difficult to measure but that can be expressed as sums of reactions with known values of  $\Delta H$ .

### Definitions and Conventions

**Some Standard States.** The enthalpy change of a reaction depends on the states of the substances involved. Thus, in the formation of water,

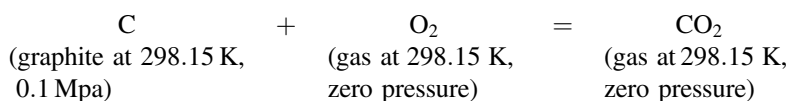




if the H<sub>2</sub>O produced is a liquid,  $\Delta H$  will differ from that observed if the H<sub>2</sub>O is a vapor. Similarly, for nonideal gases, the enthalpy change of the reaction depends on the pressure of any gases involved. Furthermore, for reactions involving solids, such as sulfur,  $\Delta H$  depends on which crystalline form (for example, rhombic or monoclinic) participates in the reaction. For these reasons, tabulated values of  $\Delta H$  refer to reactions with the reactants and products in specified *standard states*.

The states that have been agreed on as reference states in tabulating enthalpies of reaction are summarized in Table 4.1. Other standard states may be adopted in special problems. When no state is specified, it can be assumed to be that listed in Table 4.1.

**Enthalpy of Formation.** Tables of enthalpies of reaction generally list the enthalpies of formation of various compounds in their standard states from the elements in their standard states at the specified temperature. Thus, if the standard molar enthalpy of formation,  $\Delta_f H_m^\circ$ , of CO<sub>2</sub> at 25°C is given as  $-393.509 \text{ kJ mol}^{-1}$ , the following equation is implied:



$$\Delta_f H_m^\circ = -393.509 \text{ kJ mol}^{-1}$$

**TABLE 4.1. Standards and Conventions for Enthalpies of Reaction<sup>a</sup>**

Standard state of solid	The most stable form at 0.1-MPa (1 bar) pressure and the specified temperature (unless otherwise specified) <sup>b</sup>
Standard state of liquid	The most stable form at 0.1-MPa (1 bar) pressure and the specified temperature
Standard state of gas	Zero pressure <sup>c</sup> and the specified temperature
Standard state of carbon	Graphite
Reference temperature	25°C (298.15 K)
Sign of $\Delta H$	+If heat is absorbed

<sup>a</sup>The International Union of Pure and Applied Chemistry now recommends a standard pressure of 0.1 MPa (1 bar) in place of the previously accepted standard of 101.325 kPa (1 atm). The difference in thermodynamic quantities is not significant for condensed phases, and differences in  $\Delta H$  values are not significant even for gases, but the user of thermodynamic tables will have to note carefully the standard state chosen for any compilation of data. See Ref. 1, pp. 2–23; IUPAC Division of Physical Chemistry, Commission on Symbols, Terminology and Units, Manual of symbols and terminology for physico-chemical quantities and units, M. L. McGlashan, M. A. Paul, and D. N. Whiffen, eds., *Pure and Applied Chem.* **51**, 1 (1979), and Appendix IV, *Pure and Applied Chem.* **54**, 1239 (1982).

<sup>b</sup>Thus, for some problems, rhombic sulfur may be a convenient standard state, whereas for others, monoclinic sulfur may be a convenient standard state.

<sup>c</sup>It is shown in Chapter 16 that internal consistency in the definition of standard states requires that zero pressure be the standard state for the enthalpy of a gas. Unfortunately, most reference sources use the convention of 0.1-MPa or 101.325-Kpa pressure. In most cases, the difference in enthalpy among these three pressures is very small.

By this definition the enthalpy of formation of an element in its standard state is zero. In other words, elements in their standard states are taken as reference states in the tabulation of enthalpies of reaction, just as sea level is the reference point in measuring geographic heights.

Modern tables of thermodynamic data are made self-consistent either by methods of iteration or by computer-assisted simultaneous solutions [1]. The value of  $\Delta H$  for any chemical reaction that can be obtained from two or more thermodynamic cycles should have the same value from each of those cycles if the data are obtained from the same tables. Any thermodynamic calculation, therefore, should be carried out using data from a single database whenever possible. Thus, in listing some values of enthalpies of formation below, we provide values from different databases in separate tables.

Data for other substances can be obtained from the following critical compilations and online in the *NIST Chemistry WebBook* at <http://www.webbook.nist.gov/chemistry/> or from the NIST-TRC Databases available on disk. (Information can be found at <http://www.nist.gov/srd/thermo.htm>, or at <http://srdata.nist.gov/gateway/gateway?keyword=thermodynamics>.) An exhaustive list of earlier sources of tabulated thermochemical data can be found in Volume 1 of *Chemical Thermodynamics, A Specialist Periodical Report* [2]. A useful list of websites containing thermodynamic data is available at <http://tiger.uic.edu/~mansoori/Thermodynamic.Data.and.Property.html>.

A recent development is the creation of an electronic database from which particular properties can be retrieved on demand [3]. This work is being lead by the Thermodynamics Research Center, which is now part of the National Institute of Standards and Technology at Boulder, Colorado.

*International Critical Tables*, McGraw-Hill, New York, 1933.

Landolt-Börnstein, *Physikalisch-chemische Tabellen*, 5th ed., Springer, Berlin, 1936; Landolt-Börnstein, *Zahlenwerte und Funktionen*, 6th ed., Springer-Verlag, Berlin, 1961, 1963, 1967, 1972.

Landolt-Börnstein, Volume 19, *Thermodynamic Properties of Inorganic Materials*, Subvolume A1, *Pure Substances. Part 1: Elements and Compounds from AgBr to Ba<sub>3</sub>N<sub>2</sub>*, P. Franke and D. Neuschütz Guest eds., 1999, <http://www.springerlink.com/link.asp?id=KH6W2TX1RQ77>.

Subvolume A2, *Pure Substances. Part 2: Compounds from BeBr(g) to ZrCl<sub>2</sub>(g)*, 1999, <http://www.springerlink.com/link.asp?id=4EEKKY1F24PE>.

Subvolume A3, *Pure Substances. Part 3: Compounds from CoCl<sub>3</sub> to Ge<sub>3</sub>N<sub>4</sub>*, <http://www.springerlink.com/link.asp?id=NEGDT64X4YVX>.

Subvolume A4, *Pure Substances. Part 4: Compounds from HgH(g) to ZnTe(g)*. <http://www.springerlink.com/link.asp?id=92D3BEBCG7H0>.

Subvolume B1, *Binary Systems. Part 1: Elements and Binary Systems from Ag-Al to Au-Tl*, P. Franke and D. Neuschüt, Guest eds., 2002, <http://www.springerlink.com/link.asp?id=B5BVPDD2PX27>.

- Subvolume B2, *Thermodynamic Properties of Inorganic Materials: Binary Systems. Part 2: Elements and Binary Systems from B–C to Cr–Zr*, 2004, <http://www.springerlink.com/link.asp?id=Q4AMK7NV6RFN>.
- Subvolume B3, *Thermodynamic Properties of Inorganic Materials: Binary Systems. Part 3: Binary Systems from Cs–K to Mg–Zr*, 2005. <http://www.springerlink.com/link.asp?id=N4NFQ36PTE6B>.
- W. M. Latimer, *Oxidation Potentials*, 2nd ed., Prentice-Hall, Englewood Cliffs, NJ, 1952.
- D. R. Stull and G. C. Sinke, *Thermodynamic Properties of the Elements*, American Chemical Society, Washington, DC, 1956.
- M. W. Chase, ed., *NIST-JANAF Thermochemical Tables*, 4th ed., *J. Phys. Chem. Ref. Data*, Monograph No. 9 (Part I and Part II), 1998.
- R. A. Robie and B. S. Hemingway, Thermodynamic properties of minerals and related substances, *Geological Survey Bulletin 2131*, 1995.
- L. B. Pankratz, J. M. Stue, and N. A. Gokcen, *Bureau of Mines Bulletin 677*, 1984.
- S. G. Lias, J. E. Bartmess, J. F. Liebman, J. L. Holmes, R. D. Levin, and W. G. Mallard, Gas-Phase Ion and Neutral Thermochemistry, *J. Phys. Chem. Ref. Data*, **17**, Supplement No. 1, 1988.
- L. V. Gurvich, I. V. Veyts, and C. B. Alcock, eds., *Thermodynamic Properties of Individual Substances*, Vol. 3, Parts 1 and 2, CRC Press, Boca Raton, FL, 1994.

**TABLE 4.2. Standard Enthalpies<sup>a</sup> of Formation at 298.15 K**

Substance	$\Delta_f H_m^\circ / (\text{kJ mol}^{-1})$	Substance	$\Delta_f H_m^\circ / (\text{kJ mol}^{-1})$
H(g)	217.965	CO(g)	−110.525
O(g)	249.170	CO <sub>2</sub> (g)	−393.509
Cl(g)	121.679	NH <sub>3</sub> (g)	−46.11
Br(g)	111.884	Glycine(s)	−528.10
F(g)	78.99	Taurine(s)	−785.3
NO(g)	90.25	Acetic acid(l)	−484.5
I(g)	106.838	Urea(s)	333.51
N(g)	472.704	CaSiO <sub>3</sub> (s); wollastonite	−1634.94
C(g)	716.682	CuSO <sub>4</sub> ·5H <sub>2</sub> O(s); chalcantinite	−2279.65
Br <sub>2</sub> (g)	30.907	SiO <sub>2</sub> (s); α quartz	−910.94
I <sub>2</sub> (g)	62.438	SiO <sub>2</sub> (s); α cristobalite	−909.48
H <sub>2</sub> O(g)	−241.818	SiO <sub>2</sub> (s); α tridymite	−909.06
H <sub>2</sub> O(l)	−285.830	Mg <sub>2</sub> SiO <sub>4</sub> (s); forsterite	−2174.0
HF(g)	−271.1	MgSiO <sub>3</sub> (s); enstatite	−1549.00
HD(g)	0.318	Methane(g)	−74.81
C(diamond)	1.895	Ethane(g)	−84.68
HCl(g)	−92.307	Ethene(g)	52.26
HBr(g)	−36.40	Ethyne(g)	226.73
HI(g)	26.48	Methanol(l)	−238.66
ICl(g)	17.78	Ethanol(l)	−277.69

<sup>a</sup>Selected from Ref. 1.

**TABLE 4.3. Standard Enthalpies<sup>a</sup> of Formation at 298.15 K**

Substance	$\Delta_f H_m^\circ / (\text{kJ mol}^{-1})$	Substance	$\Delta_f H_m^\circ / (\text{kJ mol}^{-1})$
HBr(g)	-36.443	H <sub>2</sub> O(g)	-241.826
CO(g)	-110.527	NH <sub>3</sub> (g)	-45.898
CO <sub>2</sub> (g)	-393.522	HF(g)	-272.546
		HCl(g)	-92.312

<sup>a</sup>M. W. Chase, Jr., NIST-JANAF thermochemical tables, 4th ed. *J. Phys. Chem. Ref. Data*, Monograph No. 9, 1998.

J. B. Pedley, *Thermochemical Data and Structures of Organic Compounds*, Vol. I, Thermodynamics Research Center, College Station, TX, 1994.  
<http://www.fiz-chemie.de/infotherm/servlet/infothermSearch>.

An updated electronic version of these tables is available as NIST Standard Reference Database 85; information can be found at <http://trs.nist.gov/database/Table/wintable.htm>.

Quantum-chemical calculations now can provide values of enthalpies of formation with a precision and accuracy comparable with thermochemical values and those calculated from statistical thermodynamics. The basis for these calculations is beyond the scope of this text, but it is interesting to observe some values calculated in this way for comparison with other values in Tables 4.3–4.5. The data in Table 4.6 were obtained by a method called Gaussian-3 (G3) [5].

**TABLE 4.4. Standard Enthalpies<sup>a</sup> of Formation at 298.15 K**

Substance	$\Delta_f H_m^\circ / (\text{kJ mol}^{-1})$	Substance	$\Delta_f H_m^\circ / (\text{kJ mol}^{-1})$
Br <sub>2</sub> (g)	30.9 ± 0.1	CuSO <sub>4</sub> (s)	-771.4 ± 1.3
I <sub>2</sub> (g)	62.4 ± 0.1	CuSO <sub>4</sub> · 5H <sub>2</sub> O(s); chalcantite	-2279.7 ± 3.4
C(diamond)	1.9 ± 0.0	CaSO <sub>4</sub> · 2H <sub>2</sub> O(s)	-2023.0 ± 4.3
CO(g)	-110.5 ± 0.2	CaSO <sub>4</sub> (s)	-1434.4 ± 4.2
CO <sub>2</sub> (g)	393.5 ± 0.1	CaSiO <sub>3</sub> (s); wollastonite	-1634.8 ± 1.4
NO <sub>2</sub> (g)	33.1 ± 0.4	SiO <sub>2</sub> (s); α quartz	-910.7 ± 1.0
Br <sub>2</sub> (g)	30.9 ± 0.1	CuSO <sub>4</sub> (s)	-771.4 ± 1.3
SO <sub>2</sub> (g)	-296.8 ± 0.2	SiO <sub>2</sub> (s); α cristobalite	-908.4 ± 2.1
SO <sub>3</sub> (g)	-395.7 ± 0.1	SiO <sub>2</sub> (s); α tridymite	-907.5 ± 2.4
S(monoclinic)	0.3 ± 0.1	CH <sub>4</sub> (g)	-74.8 ± 0.3
MgO(s)	-601.6 ± 0.3	NH <sub>3</sub> (g)	-45.9 ± 0.4
Mg <sub>2</sub> SiO <sub>4</sub> (s); forsterite	-2173.0 ± 2.0	Fe <sub>2</sub> SiO <sub>4</sub> (s); fayalite	-1478.2 ± 1.3
K <sub>2</sub> SO <sub>4</sub> ; arcanite	-1437.7 ± 0.5	Fe <sub>2</sub> O <sub>3</sub> ; hematite	-826.2 ± 1.3
Fe <sub>2</sub> (SO <sub>4</sub> ) <sub>3</sub>	-2581.9 ± 2.9	H <sub>2</sub> O(g)	-241.8 ± 0.0
H <sub>2</sub> O(l)	-285.8 ± 0.1		

<sup>a</sup>R. A. Robie and B. S. Hemingway, Thermodynamic properties of minerals and related substances, *Geological Survey Bulletin* 2131, 1995.

**TABLE 4.5. Standard Enthalpies<sup>a</sup> of Formation at 298.15 K**

Substance	$\Delta_f H_m^\circ / (\text{kJ mol}^{-1})$	Substance	$\Delta_f H_m^\circ / (\text{kJ mol}^{-1})$
Methane(g)	-74.5	<i>o</i> -Xylene(g)	19.1
Ethane(g)	-83.8	<i>m</i> -Xylene(g)	17.3
Propane(g)	-104.7	<i>p</i> -Xylene(g)	18.0
<i>n</i> -Butane(g)	-126.8	Methanol(g)	-200.9
Ethylene(g)	52.5	Ethanol(g)	-235.0
Propylene(g)	19.7	CO(g)	-110.5
1-Butene(g)	-0.5	CO <sub>2</sub> (g)	-393.5
Acetylene(g)	228.2	Acetic acid(g)	-432.3
Benzene(g)	82.9	Toluene(g)	50.2
Cyclohexane(g)	-123.4		

<sup>a</sup>From Ref. 4.**TABLE 4.6. Standard Enthalpies of Formation at 298.15 K\***

Substance	$\Delta_f H_f^\circ / (\text{kJ mol}^{-1})$	Substance	$\Delta_f H_f^\circ / (\text{kJ mol}^{-1})$
CH <sub>4</sub> (g)	-74.9	Ethylene(g)	52.3
NH <sub>3</sub> (g)	-46.0	Ethane(g)	-84.1
H <sub>2</sub> O(g)	-241.8	CO(g)	-110.5
HF(g)	-272.4	CO <sub>2</sub> (g)	-393.7
Acetylene(g)	226.8		

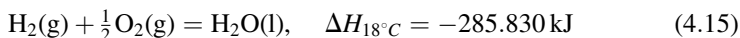
\*L. A. Curtiss, K. Raghavachari, P. C. Redfern, V. Rassolov, and J. A. Pople, *J. Chem. Phys.* **109**, 7764 (1998).

### 4.3 ENTHALPY AS A STATE FUNCTION

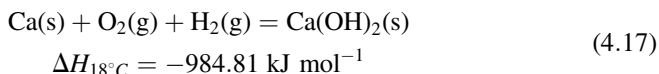
Because the enthalpy is a thermodynamic property, the value of  $\Delta H$  depends only on the nature and state of the initial reactants and final products, and not on the reactions that have been used to carry out the transformation. If we must deal with a reaction whose  $\Delta H$  is not available, it is sufficient to find a series of reactions for which  $\Delta H^\circ$ 's are available and whose sum is the reaction in question.

#### Enthalpy of Formation from Enthalpy of Reaction

As the formation of Ca(OH)<sub>2</sub>(solid) from the elements is not a calorimetrically accessible reaction, we will calculate the enthalpy of formation of Ca(OH)<sub>2</sub>(solid) from data for other reactions, such as follows [6]:

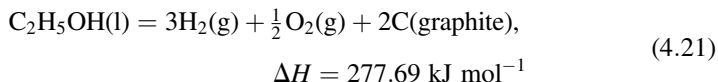
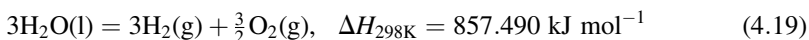
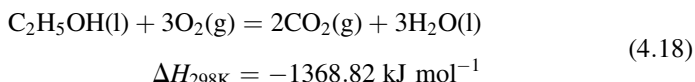


The addition of these three chemical equations leads to the desired equation; hence, the addition of the corresponding  $\Delta H$ 's gives the desired enthalpy of formation:

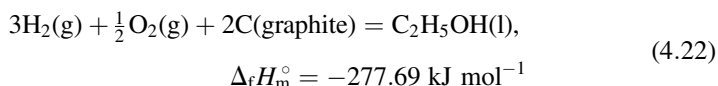


### Enthalpy of Formation from Enthalpy of Combustion

Calculation of the enthalpy of formation from the enthalpy of combustion is common because for most organic compounds, combustion is the most calorimetrically accessible reaction; yet the enthalpy of formation is the more useful quantity for additional thermodynamic calculations. A typical example of such a calculation is outlined by Equations (4.18)–(4.21):

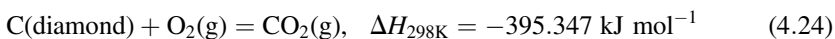
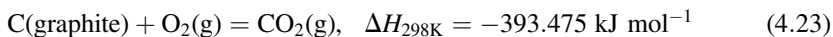


Reversing Equation (4.21), we obtain the enthalpy of formation of ethyl alcohol:

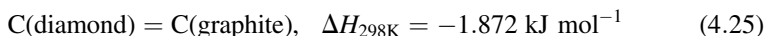


### Enthalpy of Transition from Enthalpy of Combustion

Calculation of the enthalpy of transition in the solid state from the enthalpy of combustion is particularly important when changes of reference state from one allotrope to another are necessary. Carbon is illustrated as an example [7]:



Subtracting the first reaction from the second, we obtain



The enthalpy change for the transition from graphite to diamond is an essential item of information in calculation of the conditions for the geological and industrial production of diamonds.

### Enthalpy of Conformational Transition of a Protein from Indirect Calorimetric Measurements [8]

Many protein molecules exist in two (or more) different structures of the same molecular mass but with different spatial disposition of constituent atoms. An intensively studied enzyme, aspartate transcarbamoylase (abbreviated ATCase), under some circumstances is in an enzymatically less-active constrained steric arrangement, which is labeled the T form, and under other conditions in the enzymatically very active, structurally more swollen and open conformation, the R form.

The  $\Delta H_{T \rightarrow R}$  of the transition from T to R is a thermodynamically valuable parameter for understanding the behavior of the enzyme. However, this quantity cannot be measured directly because the transition can only be achieved by addition of a small-molecule substrate or an analog thereof. One such analog, N-(phosphonacetyl)-L-aspartate (PALA), is very effective in promoting the  $T \rightarrow R$  transition. Calorimetric measurements have been reported [8] for the mixed process of binding the PALA and the accompanying  $T \rightarrow R$  transition. The observed  $\Delta H_m$  values (per mole of enzyme) depend on the number of moles of PALA bound.

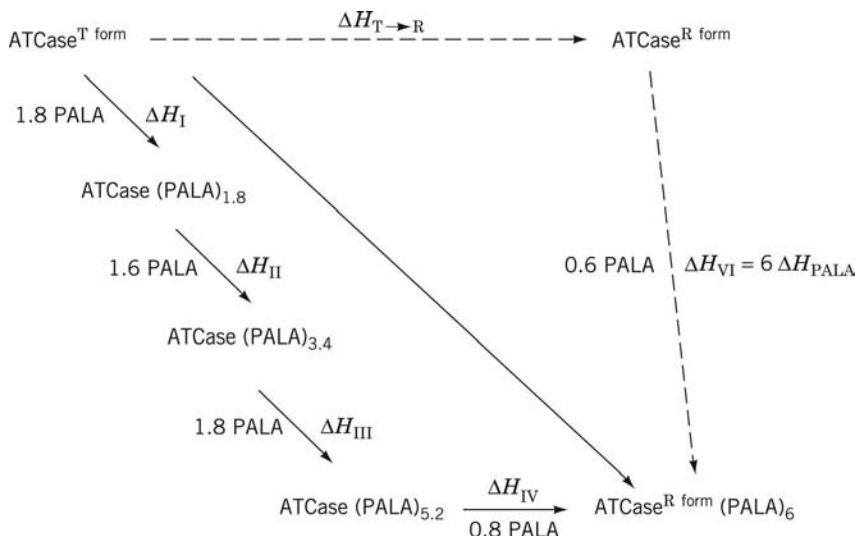
The different transitions for which calorimetric data have been obtained and the relationships of the experimental  $\Delta H_m$  values to the enthalpy of transition,  $\Delta H_{m(T \rightarrow R)}$ , and to the enthalpy of binding of PALA,  $\Delta H_{mPALA}$ , are shown in Figure 4.1, which is a thermodynamic cycle that permits calculation of  $\Delta H_m$  for one step if all others are known. Each enthalpy  $\Delta H_{mI}$  to  $\Delta H_{mV}$ , in principle, contains some contribution from the enthalpy of binding and some from the enthalpy of conformational transition. It has been assumed that the enthalpy of binding per mole of ligand,  $\Delta H_{mPALA}$ , is identical for each of the six PALA molecules taken up sequentially by the enzyme. Thus,

$$\Delta H_{mVI} = 6\Delta H_{mPALA} \quad (4.26)$$

However  $\Delta H_{mVI}$  is not accessible directly by calorimetric measurements. In each step,  $\Delta H_{mI}$  to  $\Delta H_{mV}$ , the contribution from  $\Delta H_{m(T \rightarrow R)}$  cannot be established without some knowledge of the extent of the conformational transition, which is known not to be proportional to the number of moles of bound PALA.

Extrathermodynamic (ultracentrifugation) experiments have established that 43% of the conformational transition occurs when the first 1.8 moles of ligand is added. Therefore, we can write

$$\Delta H_{mI} = 1.8 \Delta H_{mPALA} + 0.43 \Delta H_{m(T \rightarrow R)} \quad (4.27)$$



**Figure 4.1.** Thermodynamic cycles, which illustrate states of enzyme ATCase during calorimetric measurements of enthalpies accompanying the binding of progressively increasing quantities of the substrate analog PALA. At the outset, the ATCase is 100% in the T conformation; at the conclusion of the transformation, the  $\text{ATCase}^{\text{R form}}(\text{PALA})_6$  is 100% in the R conformation and has six bound PALA molecules. When the extent of binding of PALA is between 0 and 6, the extent of conformational conversion is between 0% and 100%. The horizontal broken arrow at the top of the diagram indicates the process that is accompanied by the enthalpy  $\Delta H_{\text{T} \rightarrow \text{R}}$  that we want to know. The vertical broken arrow at the right represents a pure binding step for the enzyme in the 100% R conformation.

Similarly, it is known that when the bound PALA is increased from 3.4 to 5.2, 23% of the conformational transition takes place. Therefore, for the additional binding of 1.8 moles of PALA, in the third step of the left-hand path of Figure 4.2, we can state that

$$\Delta H_{\text{mIII}} = 1.8 \Delta H_{\text{mPALA}} + 0.23 \Delta H_{\text{m(T} \rightarrow \text{R)}} \quad (4.28)$$

Using the experimentally determined values for  $\Delta H_{\text{mI}}$  and  $\Delta H_{\text{mIII}}$ ,  $-63.2 \text{ kJ mol}^{-1}$  and  $-59.0 \text{ kJ mol}^{-1}$ , respectively, shown in Table 4.7, we can solve Equations (4.27) and (4.28) for the  $\Delta H_{\text{m}}$ 's of the two inaccessible steps in Figure 4.1. In this way it has been shown that

$$\Delta H_{\text{m(T} \rightarrow \text{R)}} = -21 \text{ kJ/mol}^{-1}$$

$$\Delta H_{\text{mPALA}} = -30 \text{ kJ/mol}^{-1}$$

Alternatively, we can use the experimental calorimetric data for the diagonal path in Figure 4.1, that is, for the addition of 6 moles of ligand in one step. According to



**TABLE 4.7. Enthalpy Change on Binding PALA to ATCase**

Change in Moles PALA Bound per Mole ATCase	0.0 → 1.8	1.8 → 3.4	3.4 → 5.2	0.0 → 6.0
$\Delta H_m / (\text{kJ mol}^{-1})$	-63.2	-62.3	-59.0	-209.2

the table,  $\Delta H_{mV}$  is  $-209.2 \text{ kJ mol}^{-1}$ . Consequently we can write

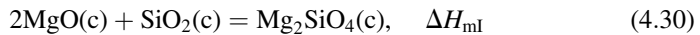
$$\Delta H_{mV} = 6 \Delta H_{m\text{PALA}} + \Delta H_{m(\text{T} \rightarrow \text{R})} \quad (4.29)$$

This equation can be combined with either Equation (4.27) or (4.28), and in each procedure alternative values can be computed for  $\Delta H_{m(\text{T} \rightarrow \text{R})}$  and for  $\Delta H_{m\text{PALA}}$ .

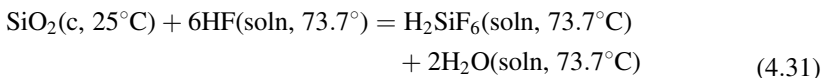
An additional method makes use of all three equations simultaneously to take advantage of all data available. In such an overdetermined set of data, one can use the method of least squares (see Appendix A) for more than one independent variable and matrix methods to solve the resulting equations [9].

### Enthalpy of Solid-State Reaction from Measurements of Enthalpy of Solution

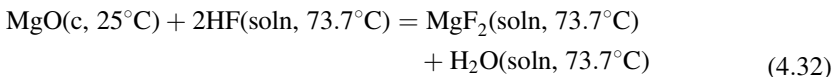
Many reactions of geological interest have crystalline (c) solids as reactants and products. Even when such reactions have large values of  $\Delta H_m$ , the enthalpy of reaction cannot be measured directly because the reactions are very slow. An important reaction of this kind is that of MgO (periclase) and SiO<sub>2</sub> (quartz) to form forsterite (Mg<sub>2</sub>SiO<sub>4</sub>).



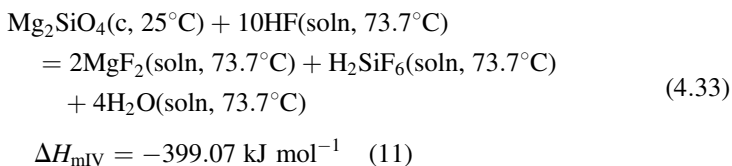
Workers at the Bureau of Mines were able to obtain  $\Delta H_{mI}$  by measurements of the value of  $\Delta H_m$  for the reaction of each of the solids with 20% HF solutions near 75°C. The reactions observed are as follows:



$$\Delta H_{mII} = -148.16 \text{ kJ mol}^{-1} \quad (10)$$



$$\Delta H_{mIII} = -162.13 \text{ kJ mol}^{-1} \quad (10)$$



From an inspection of the reactions, one can see that

$$\begin{aligned}
 \Delta H_{\text{mI}} & = 2(\Delta H_{\text{mIII}}) + \Delta H_{\text{mII}} - \Delta H_{\text{mIV}} \\
 & = -73.35 \text{ kJ mol}^{-1} \qquad (4.34)
 \end{aligned}$$

#### 4.4 BOND ENTHALPIES

The calculation of the enthalpy of formation of a given compound depends on the determination of the enthalpy of at least one reaction of this substance. Frequently, it is desirable to estimate the enthalpy of a chemical reaction involving a hitherto unsynthesized compound, or one that has been synthesized but has not been characterized calorimetrically. For the solution of problems of this type, a system of average bond enthalpies has been established such that, if the molecular structure of the compound is known, it is possible to approximate the enthalpy of formation by adding the appropriate average bond enthalpies.

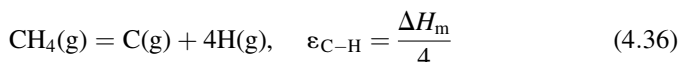
##### Definition of Bond Enthalpies

We must be careful to distinguish between “bond enthalpy” and the “dissociation enthalpy” of a given bond. The latter is a definite quantity that refers to the enthalpy absorbed when a given bond of some specific compound is broken. However, *bond enthalpy* is an average value of the dissociation enthalpies of a given bond in a series of different dissociating species.

The distinction between these two terms may be more evident if described in terms of a simple example, the C–H bond. The enthalpy of dissociation of the C–H bond depends on the nature of the molecular species from which the H atom is being separated. For example, in the methane molecule



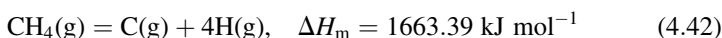
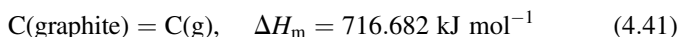
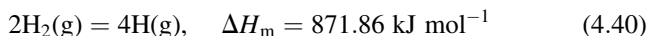
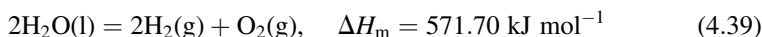
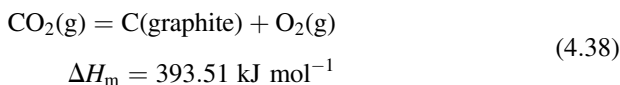
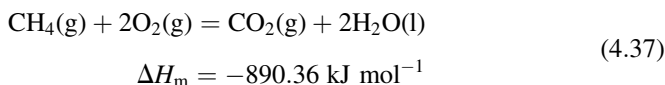
the dissociation enthalpy of the carbon–hydrogen bond in methane [12] is 427 kJ mol<sup>-1</sup>. This value is not equal to the *average bond enthalpy* of the C–H bond,  $\varepsilon_{\text{C-H}}$ . One reaction by which we can obtain a value of  $\varepsilon_{\text{C-H}}$  is



From experiments with many compounds in which the C–H bond is broken and from an average of the results, we can attain a representative value for  $\varepsilon_{\text{C-H}}$ , for example, 415.85 kJ mol<sup>-1</sup>.

### Calculation of Bond Enthalpies

The fundamental data for calculating  $\Delta H_m$  for Equation (4.36) are obtained from enthalpies of combustion. We will calculate the C–H bond enthalpy from data on the enthalpy of combustion of methane. Consider the following reactions at 298 K:



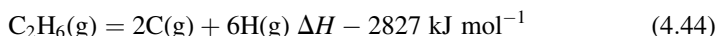
Thus, at 298 K

$$\varepsilon_{\text{C-H}} = \frac{1663.39}{4} = 415.85 \text{ kJ mol}^{-1} \quad (4.43)$$

This value of the C–H bond enthalpy does not correspond to the enthalpy of dissociation of the carbon–hydrogen bond in methane, as represented in Equation (4.35).

In the preceding calculation of  $\varepsilon_{\text{C-H}}$ , enthalpy values at 298 K were used; hence, the bond enthalpy also refers to this temperature. For some purposes, it is the practice to calculate bond enthalpies at 0 K, rather than 298 K. For  $\varepsilon_{\text{C-H}}$ , we would obtain  $410.9 \text{ kJ mol}^{-1}$  at 0 K, which is a value slightly lower than that at 298 K. Generally, the differences between the bond enthalpies at the two temperatures are small. A list of bond enthalpies at 298 K is given in Table 4.8.

In some cases, the value given in the table depends on that calculated previously for some other bond. For example, to obtain  $\varepsilon_{\text{C-C}}$ , we combine the enthalpy of combustion of ethane,  $-1,588 \text{ kJ mol}^{-1}$ , with the proper multiples of the  $\Delta H_m$ 's in Equations (4.38)–(4.41) to obtain the enthalpy change for the reaction



From our definition of bond enthalpy

$$\varepsilon_{\text{C-C}} = \Delta H_{\text{m Equation (4.44)}} - 6\varepsilon_{\text{C-H}} \quad (4.45)$$

TABLE 4.8. Bond Enthalpies<sup>a</sup> at 298 K

Bond	kJ mol <sup>-1</sup>	Bond	kJ mol <sup>-1</sup>	Bond	kJ mol <sup>-1</sup>
H-H	435.89	Te=Te	222*	O-Cl	218
Li-Li	105*	I-I	150.88	F-Cl	253.1*
C-C	345.6	Cs-Cs	43.5*	Na-Cl	410*
C=C	610.0	Li-H	243	Si-Cl	381
C≡C	835.1	C-H	413.0	P-Cl	326
N-N	163	N-H	390.8	S-Cl	255
N≡N	944.7	O-H	462.8	K-Cl	423*
O-O	146	F-H	565	Cu-Cl	368*
O=O	498.3	Na-H	197*	As-Cl	293
F-F	155	Si-H	318	Se-Cl	243
Na-Na	71*	P-H	322	Br-Cl	218*
Si-Si	222	S-H	347	Rb-Cl	428*
P-P	201	Cl-H	431.4	Ag-Cl	301*
S-S	226	K-H	180*	Sn-Cl	318
Cl-Cl	242.13	Cu-H	276*	Sb-Cl	310
K-K	49.4*	AsH	247	I-Cl	209*
Ge-Ge	188	Se-H	276	Cs-Cl	423*
As-As	146	Br-H	365.7	C-N	304.6
As≡As	381*	Rb-H	163*	C≡N	889.5
Se-Se	209	Ag-H	243*	C-O	357.7
Se=Se	272*	Te-H	238	C=O	745
Br-Br	192.80	I-H	298.7	C≡O	1046
Rb-Rb	45.2*	Cs-H	176*	P≡N	577*
Sn-Sn	163	Li-Cl	481*	S=O	498
Sb-Sb	121	C-Cl	339	C-S	272
Sb≡Sb	289*	N-Cl	192	C=S	536

<sup>a</sup>Calculated from data in T. L. Cottrell. *The Strengths of Chemical Bonds*, 2nd ed., Butterworths, London, 1958, pp. 270-289; and from data in A. G. Gaydon. *Dissociation Energies*, 3rd ed., Chapman and Hall, Ltd., London, 1968.

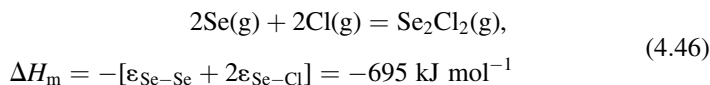
\*When values at 298 K have not been available, those at 0 K have been listed instead.

Thus, the value of 345.6 kJ mol<sup>-1</sup> listed in Table 4.8 is based on an  $\epsilon_{C-H}$  of 413.0 kJ mol<sup>-1</sup>. Other estimates of  $\epsilon_{C-H}$  would lead to different values for  $\epsilon_{C-C}$ .

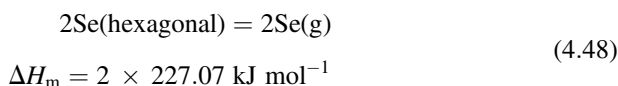
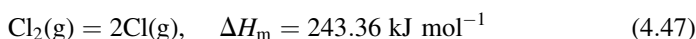
### Enthalpy of Reaction from Bond Enthalpies

The primary significance of bond enthalpies lies in the calculation of the enthalpy of a reaction involving a compound for which no enthalpy data are available. For example, if the enthalpy of formation of Se<sub>2</sub>Cl<sub>2</sub>(g) were not known, it could be calculated from bond enthalpies by the following steps. As the bond enthalpy refers to the dissociation of Cl-Se-Se-Cl gas into gaseous atoms, the enthalpy change for the formation of this gaseous molecule from the atoms should

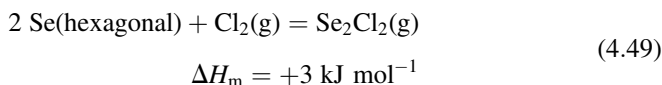
be given by



However, to estimate the standard enthalpy of formation, it is necessary to add two reactions to Equation (4.46), because, by definition, the standard enthalpy of formation refers to the formation of the compound in its standard state from the elements in their standard states. Therefore we introduce the following enthalpy changes to convert the elements from their standard states to the gaseous atoms at 298 K:



The addition of Equations (4.46)–(4.48) leads to the expression



If we wish to know the enthalpy of formation of liquid  $\text{Se}_2\text{Cl}_2$ , we can estimate the enthalpy of condensation (perhaps from Trouton's rule [13] or by comparison with related sulfur compounds) and can add it to the value of  $\Delta H_{\text{m}}$  obtained in Equation (4.49).

By these methods, one can obtain fairly reliable estimates of enthalpies of formation of many compounds. As the bond enthalpies used are average values, they cannot be expected to result in highly accurate results for enthalpies of formation. More complex procedures also have been developed that will provide greater accuracy [14]. Related methods for estimation of thermodynamic data are discussed in Appendix A.

## 4.5 HEAT CAPACITY

We introduced the enthalpy function particularly because of its usefulness as a measure of the heat that accompanies chemical reactions at constant pressure. We will find it convenient also to have a function to describe the temperature dependence of the enthalpy at constant pressure and the temperature dependence of the energy at constant volume. For this purpose, we will consider a new quantity, the heat capacity. (Historically, heat capacity was defined and measured much earlier than were enthalpy and energy.)

**Definition**

**Fundamental Statement.** The heat absorbed by a body (not at a transition temperature) is proportional to the change in temperature:

$$Q = C(T_2 - T_1) \quad (4.50)$$

The proportionality constant  $C$  is called the *heat capacity*<sup>2</sup> and is proportional to the mass of the substance undergoing the temperature change. Hence, the heat capacity per gram is called the *specific heat*, and the heat capacity for one mole of material is called the *molar heat capacity*.

The value of  $C$ ,

$$C = \frac{Q}{T_2 - T_1} = \frac{Q}{\Delta T} \quad (4.51)$$

may depend on the temperature. Thus, for a rigorous definition of heat capacity, we must consider an infinitesimally small temperature interval. Consequently we define the heat capacity by the expression

$$C = \frac{DQ}{dT} \quad (4.52)$$

in which the  $D$  in  $DQ$  emphasizes the inexactness of the differential of  $Q$ . As  $DQ$  is inexact,  $C$  has no unique value but depends on the path or conditions under which heat is supplied. We can place certain restrictions on Equation (4.52), such as constant pressure or constant volume. For these situations, we can modify Equation (4.52) to the following expressions:

$$C_P = \left( \frac{DQ}{dT} \right)_P \quad (4.53)$$

and

$$C_V = \left( \frac{DQ}{dT} \right)_V \quad (4.54)$$

**Derived Relationships.** Equations (4.52)–(4.54) are fundamental definitions. From these and previous thermodynamic principles, new relationships can be derived that are very useful in other work.

If we have a substance that is absorbing heat at a constant pressure, it is evident that the restrictions placed on Equation (4.4) are being fulfilled; that is,

$$DQ_P = dH_P$$

<sup>2</sup>The term “heat capacity” is a historical remnant of the time when it was thought that heat is stored in an object; we now consider that *thermal energy* is contained in an object and that heat is energy being transferred because of a difference in temperature.

Substitution of Equation (4.4) into Equation (4.53) leads to the important expression

$$C_P = \left( \frac{\partial H}{\partial T} \right)_P \quad (4.55)$$

As  $dH$  is exact,  $C_P$  has a definite value for a particular substance in a specified state.

Similarly, if we have a substance that is absorbing heat at constant volume, the restrictions placed on Equation (4.7) are being fulfilled; hence,

$$DQ_V = dU_V \quad (4.56)$$

Substitution of Equation (4.56) into Equation (4.54) leads to an additional basic relationship,

$$C_V = \left( \frac{\partial U}{\partial T} \right)_V \quad (4.57)$$

### Some Relationships between $C_P$ and $C_V$

From the considerations of the preceding section, no apparent connection is found immediately between the two heat capacities,  $C_P$  and  $C_V$ . We can illustrate the power of thermodynamic methods by developing several such relationships without any assumptions beyond the first law of thermodynamics and the definitions that have been made already. The following three examples are of derivations of these relationships:

1. Starting with the derived relationship for  $C_P$  [Equation (4.55)], we introduce the definition of  $H$ :

$$C_P = \left[ \frac{\partial(U + PV)}{\partial T} \right]_P = \left( \frac{\partial U}{\partial T} \right)_P + P \left( \frac{\partial V}{\partial T} \right)_P \quad (4.58)$$

The partial derivative  $(\partial U / \partial T)_P$  is not  $C_V$ , but if it could be expanded into some relationship with  $(\partial U / \partial T)_V$ , we would have succeeded in introducing  $C_V$  into Equation (4.58). The necessary relationship can be derived by considering the internal energy  $U$  as a function of  $T$  and  $V$  and setting up the total differential:

$$dU = \left( \frac{\partial U}{\partial T} \right)_V dT + \left( \frac{\partial U}{\partial V} \right)_T dV \quad (4.59)$$

Dividing by  $dT$  and imposing the condition of constant pressure, we obtain

$$\left( \frac{\partial U}{\partial T} \right)_P = \left( \frac{\partial U}{\partial T} \right)_V + \left( \frac{\partial U}{\partial V} \right)_T \left( \frac{\partial V}{\partial T} \right)_P \quad (4.60)$$

Substituting Equation (4.60) into Equation (4.58) and factoring out the partial derivative  $(\partial V/\partial T)_P$ , we obtain the desired expression:

$$\begin{aligned} C_P &= \left(\frac{\partial U}{\partial T}\right)_V + \left[P + \left(\frac{\partial U}{\partial V}\right)_T\right] \left(\frac{\partial V}{\partial T}\right)_P \\ &= C_V + \left[P + \left(\frac{\partial U}{\partial V}\right)_T\right] \left(\frac{\partial V}{\partial T}\right)_P \end{aligned} \quad (4.61)$$

This expression will be of considerable value when we consider special cases for which values or equations for the partial derivatives  $(\partial U/\partial V)_T$  and  $(\partial V/\partial T)_P$  are available.

2. A second relationship can be derived by starting with the definition for  $C_V$  [Equation (4.57)] and by substituting from the relation between  $U$  and  $H$ .

$$\begin{aligned} C_V &= \left(\frac{\partial U}{\partial T}\right)_V = \left[\frac{\partial(H - PV)}{\partial T}\right]_V \\ &= \left(\frac{\partial H}{\partial T}\right)_V - V \left(\frac{\partial P}{\partial T}\right)_V \end{aligned} \quad (4.62)$$

The partial derivative  $(\partial H/\partial T)_V$  is not  $C_P$ , but if it could be expanded into some relationship with  $(\partial H/\partial T)_P$ , we would have succeeded in introducing  $C_P$  into Equation (4.62). The necessary relationship can be derived by considering the enthalpy  $H$  as a function of  $T$  and  $P$  and by setting up the total differential:

$$dH = \left(\frac{\partial H}{\partial T}\right)_P dT + \left(\frac{\partial H}{\partial P}\right)_T dP \quad (4.63)$$

Dividing by  $dT$  and imposing the condition of constant volume, we obtain

$$\left(\frac{\partial H}{\partial T}\right)_V = \left(\frac{\partial H}{\partial T}\right)_P + \left(\frac{\partial H}{\partial P}\right)_T \left(\frac{\partial P}{\partial T}\right)_V \quad (4.64)$$

Substituting Equation (4.64) into Equation (4.62), and factoring out the partial derivative  $(\partial V/\partial T)_P$ , we obtain the desired expression:

$$\begin{aligned} C_V &= \left(\frac{\partial H}{\partial T}\right)_P + \left[-V + \left(\frac{\partial H}{\partial P}\right)_T\right] \left(\frac{\partial P}{\partial T}\right)_V \\ &= C_P + \left[-V + \left(\frac{\partial H}{\partial P}\right)_T\right] \left(\frac{\partial P}{\partial T}\right)_V \end{aligned} \quad (4.65)$$



or,

$$C_P = C_V + \left[ V - \left( \frac{\partial H}{\partial P} \right)_T \right] \left( \frac{\partial P}{\partial T} \right)_V \quad (4.66)$$

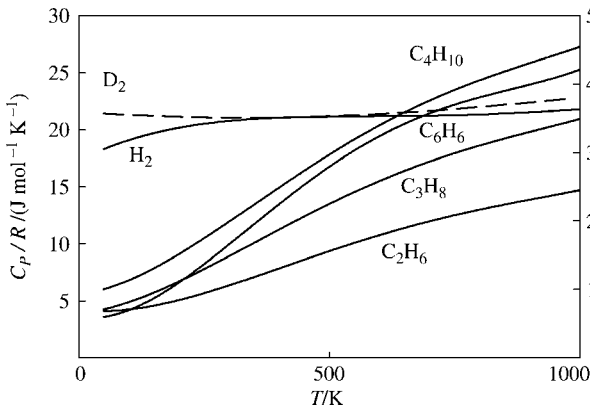
Several other general relationships between  $C_P$  and  $C_V$  are obtainable by procedures similar to those just outlined.

### Heat Capacities of Gases

From classic thermodynamics alone, it is impossible to predict numeric values for heat capacities; these quantities are determined experimentally from calorimetric measurements. With the aid of statistical thermodynamics, however, it is possible to calculate heat capacities from spectroscopic data instead of from direct calorimetric measurements. Even with spectroscopic information, however, it is convenient to replace the complex statistical thermodynamic equations that describe the dependence of heat capacity on temperature with empirical equations of simple form [15]. Many expressions have been used for the molar heat capacity, and they have been discussed in detail by Frenkel et al. [4]. We will use the expression

$$\frac{C_{Pm}}{R} = a_0 + a_1T + a_2T^2 + a_3T^3 + a_4T^4 \quad (4.67)$$

Some results of the calculations of Frenkel et al. [4] for the coefficients in this equation are summarized in Table 4.9 and are illustrated in Figure 4.2.



**Figure 4.2.** Variation of heat capacity with temperature as calculated from the equations of Frenkel et al. [4]. The differences observed between isotopic species and the way heat capacity depends on molecular size and structure can be described thermodynamically, but they must be explained by the methods of quantum-statistical thermodynamics. The right-hand scale is for  $H_2$  and  $D_2$ ; the left-hand scale is for the other compounds.

**TABLE 4.9. Coefficients in Heat Capacity Equations<sup>a</sup>**

Substance	Temperature Range/K	$a_0$	$a_1/10^{-3}$ K	$a_2/10^{-5}$ K <sup>2</sup>	$a_3/10^{-8}$ K <sup>3</sup>	$a_4/10^{-1}$ K <sup>4</sup>
H <sub>2</sub> (g)	50–1000	2.8833	3.6807	-0.7720	0.6915	-0.2125
	1000–5000	3.2523	0.20599	0.02562	-0.008887	0.000859
D <sub>2</sub> (g)	50–1000	3.5904	-0.4616	0.0572	0.0364	-0.02595
	1000–5000	2.7339	1.47478	-0.04767	0.00782	-0.000479
HD(g)	50–1000	3.893	-3.508	1.083	-1.337	0.580
	1000–5000	0.595	5.538	-0.324	0.084	-0.008
O <sub>2</sub> (g)	50–1000	3.6297	-1.7943	0.6579	-0.6007	0.17861
	1000–5000	3.4480	1.08016	-0.04187	0.00919	-0.000763
N <sub>2</sub> (g)	50–1000	3.5385	-0.2611	0.0074	0.1574	-0.09887
	1000–5000	2.8405	1.64542	-0.06651	0.01248	-0.000878
Cl <sub>2</sub> (g)	50–1000	3.0560	5.3708	-0.8098	0.5693	-0.15256
	1000–5000	4.1967	0.54228	-0.03370	0.01108	-0.001205
Br <sub>2</sub> (g)	50–1000	3.2118	7.1600	-1.5277	1.4446	-0.49867
	1000–5000	4.8113	-0.57566	0.03856	-0.00696	0.000303
H <sub>2</sub> O(g)	50–1000	4.395	-4.186	1.405	-1.564	0.632
	1000–5000	0.507	7.331	-0.372	0.089	-0.008
CO <sub>2</sub> (g)	50–1000	3.259	1.356	1.502	-2.374	1.056
	1000–5000	0.269	11.337	-0.667	0.167	-0.015
CO(g)	50–1000	3.912	-3.913	1.182	-1.302	0.515
	1000–5000	0.574	6.257	-0.374	0.095	-0.008
CNCl(g)	298–1000	2.541	15.740	-2.713	2.354	-0.787
HCl(g)	50–1000	3.827	-2.936	0.879	-1.031	0.439
	1000–5000	0.578	5.777	-0.336	0.085	-0.008
DCI(g)	50–1000	3.917	-3.965	1.205	-1.323	0.521
	1000–5000	0.567	6.328	-0.378	0.096	-0.009

(Continued)

TABLE 4.9 Continued

Substance	Temperature Range/K	$a_0$	$a_1/$ $10^{-3}$ K	$a_2/$ $10^{-5}$ K <sup>2</sup>	$a_3/$ $10^{-8}$ K <sup>3</sup>	$a_4/$ $10^{-1}$ K <sup>4</sup>
SO <sub>2</sub> (g)	50–1000	4.147	-2.234	2.344	-3.271	1.393
	1000–5000	0.391	11.636	-0.713	0.183	-0.016
SO <sub>3</sub> (g)	50–1000	3.426	6.479	1.691	-3.356	1.590
	1000–5000	0.233	16.771	-1.023	0.261	-0.023
CH <sub>4</sub> (g)	50–1000	4.568	-8.975	3.631	-3.407	1.091
	1000–5000	0.282	12.718	-0.520	0.101	-0.007
C <sub>2</sub> H <sub>6</sub> (g)	50–1000	4.178	-4.427	5.660	-6.651	2.487
	1000–5000	0.001	11.202	1.928	-2.205	0.628
C <sub>3</sub> H <sub>8</sub> (g)	50–1000	3.847	5.131	6.011	-7.893	3.079
	1000–5000	0.001	19.052	2.087	-2.682	0.785
<i>n</i> -C <sub>4</sub> H <sub>10</sub> (g)	200–1000	5.547	5.536	8.057	-10.571	4.134
	1000–1500	0.006	24.568	2.855	-3.659	1.076
<i>n</i> -C <sub>5</sub> H <sub>12</sub> (g)	200–1000	7.554	-0.368	11.846	-14.939	5.753
	1000–1500	0.008	24.320	5.170	-5.975	1.751
Benzene(g)	50–1000	3.551	-6.184	14.365	-19.807	8.234
	1000–1500	0.001	-22.947	14.018	-12.663	3.469
Pyridine(g)	298–1000	-3.505	49.389	-1.746	-1.595	1.097
Carbon (graphite)	50–400	-1.30031	21.18994	-10.16834	26.66831	-25.41989
	400–5000	0.037945	4.450695	-0.241501	0.056079	-0.004567

<sup>a</sup>Reprinted with permission from Ref. 4, pp. 532–537, pp. 575–717. See also K. K. Kelley, *U.S. Bur. Mines Bulletin* **476** (1949) and **584** (1960); NIST Chemistry WebBook: at <http://webbook.nist.gov/chemistry/>.

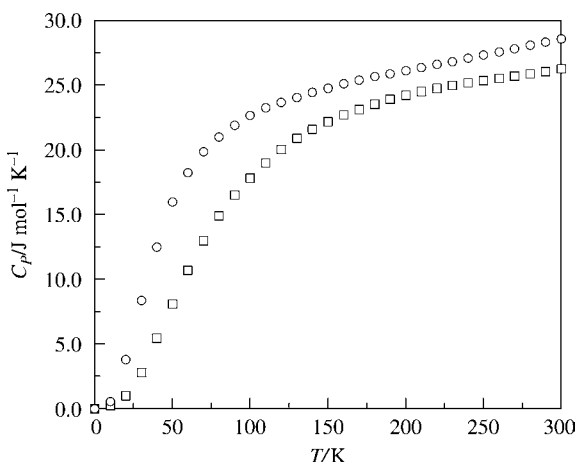
## Heat Capacities of Solids

Early in the nineteenth century, Dulong and Petit observed that the molar heat capacity of a solid element generally is near  $6 \text{ cal mol}^{-1} \text{ K}^{-1}$  ( $25 \text{ J mol}^{-1} \text{ K}^{-1}$ ). Subsequent investigation showed that  $C_{V,m}$  (or  $C_{P,m}$ ) varies markedly with the temperature, in the fashion indicated by Figure 4.3. However, the upper limiting value of about  $25 \text{ J mol}^{-1} \text{ K}^{-1}$  is approached by the heavier elements at room temperature.

Data for a large number of organic compounds can be found in E. S. Domalski, W. H. Evans, and E. D. Hearing, "Heat capacities and entropies in the condensed phase," *J. Phys. Chem. Ref. Data*, Supplement No. 1, **13** (1984). It is impossible to predict values of heat capacities for solids by purely thermodynamic reasoning. However, the problem of the solid state has received much consideration in statistical thermodynamics, and several important expressions for the heat capacity have been derived. For our purposes, it will be sufficient to consider only the Debye equation and, in particular, its limiting form at very low temperatures:

$$C_{V,m} = \frac{12\pi^4}{5} R \frac{T^3}{\Theta^3} = 1943.8 \frac{T^3}{\Theta^3} \text{ J mol}^{-1} \text{ K}^{-1} \quad (4.68)$$

The symbol  $\theta$  is called the characteristic temperature and can be calculated from an experimental determination of the heat capacity at a low temperature. This equation has been very useful in the extrapolation of measured heat capacities [16] down to 0 K, particularly in connection with calculations of entropies from the third law of thermodynamics (see Chapter 11). Strictly speaking, the Debye equation was derived only for an isotropic elementary substance; nevertheless, it is applicable to most compounds, particularly in the region close to absolute zero [17].



**Figure 4.3.** Molar heat capacities of solid sodium (○) and palladium (□). [Data from G. L. Pickard and F. E. Simon, *Proc. Phys. Soc.* **61**, 1 (1948).]

## Heat Capacities of Liquids

No adequate theoretical treatment has been developed that might serve as a guide in interpreting and correlating data on the heat capacities of liquids, but a critical review and recommended values are available for several liquids [18]. However, it has been observed that the molar heat capacity of a pure liquid generally is near that of the solid, so if measurements are not available we may assume that  $C_{V,m}$  is  $25 \text{ J mol K}^{-1}$ . However, the heat capacities of solutions cannot be predicted reliably from the corresponding properties of the components. Empirical methods of treating solutions will be considered in later chapters.

## Other Sources of Heat Capacity Data

Sources of heat capacity data at many temperatures include:

J. D. Cox, D. D. Wagman, and V. A. Medvedev, *CODATA Key Values for Thermodynamics*, Hemisphere Publishing Corporation, New York, 1989.

M. W. Chase, Jr., *JANAF Thermochemical Tables*, 4th ed., *J. Phys. Chem. Ref. Data*, Monograph No. 9 (1998).

R. A. Robie and B. S. Hemingway, Thermodynamic properties of minerals and related substances, *U. S. Geological Survey Bulletin 2131*, 1995.

NIST Webbook, <http://webbook.nist.gov/chemistry>.

<http://i-systems.dechema.de/detherm.datasets.php?>

M. Zabransky, V. Ruzicka, E. S. Domalski, *J. Phys. Chem. Ref. Data*, **30**, 1199 (2001).

G. Kreysa, ed., *Solid and Liquid Heat Capacity Data Collection*, John Wiley & Sons, New York, 1998.

The NIST Webbook gives data for heat capacity over a range of temperatures, and it provides coefficients for empirical equations for heat capacity as a function of temperature for solid, liquid, and gas phases. The latter are referred to as “Shomate equation parameters.”

## 4.6 ENTHALPY OF REACTION AS A FUNCTION OF TEMPERATURE

In the preceding sections we discussed methods of obtaining enthalpies of reaction at a fixed temperature (generally 298.15 K). In particular, we pointed out that it is possible to tabulate enthalpies of formation and bond enthalpies and to use these to calculate enthalpies of reaction. Such tables of enthalpies of formation are available for only a few standard temperatures. Frequently, however, it is necessary to know the enthalpy of a reaction at a temperature different from those available in a reference table. Therefore, we consider now the procedures that can be used to calculate the enthalpy of reaction (at constant pressure) at one temperature, from data at another temperature.

### Analytic Method

As we are interested in the variation of enthalpy with temperature, we recall from Equation (4.55) that

$$\left(\frac{\partial H}{\partial T}\right)_P = C_P$$

Such an equation can be integrated at constant pressure:

$$\int dH = \int C_P dt$$

and

$$H = \int C_P dT + H_0 \quad (4.69)$$

In Equation (4.69),  $H_0$  is an integration constant. If we are considering a chemical transformation, represented in general terms by



we can write a series of equations of the form

$$\begin{aligned} H_A &= \int C_{PA} dT + H_{0A} \\ H_B &= \int C_{PB} dT + H_{0B} \\ H_M &= \int C_{PM} dT + H_{0M} \\ H_N &= \int C_{PN} dT + H_{0N} \end{aligned} \quad (4.71)$$

For the chemical reaction 4.70, the enthalpy change  $\Delta H_m$  is given by

$$\begin{aligned} \Delta H_m &= H_{mM} + H_{mN} + \dots - H_{mA} - H_{mB} - \dots \\ &= (H_{mOM} + H_{mON} + \dots - H_{mOA} - H_{mOB} - \dots) \\ &\quad + \int C_{PmM} dT + \int C_{PmN} dT + \dots - \int C_{PmA} dT - \int C_{PmB} dT - \dots \end{aligned} \quad (4.72)$$

If we define the quantities inside the parentheses as  $\Delta H_{m0}$  and if we group the integrals together, we obtain

$$\Delta H_m = \Delta H_{m0} + \int (C_{PmM} + C_{PmN} + \dots - C_{PmA} - C_{PmB} - \dots) dT \quad (4.73)$$

or

$$\Delta H_m = \Delta H_{m0} + \int \Delta C_{Pm} dT \quad (4.74)$$

in which  $\Delta C_{Pm}$  represents the expression in the parentheses, that is, the integrand of Equation 4.73. Thus, to obtain  $\Delta H_m$  as a function of the temperature, it is necessary to know the dependence of the heat capacities of the reactants and products on the temperature, as well as one value of  $\Delta H_m$  so that  $\Delta H_{m0}$  can be evaluated.

As an example, let us consider the enthalpy of formation of  $\text{CO}_2(\text{g})$ :



The heat capacities of the substances involved can be expressed by the equations

$$\begin{aligned} C_{Pm(\text{C})} = & -1.30031 + 21.18994 \times 10^{-3} T - 10.16834 \times 10^{-5} T^2 \\ & + 26.66831 \times 10^{-8} T^3 - 25.4198 \times 10^{-11} T^4 \end{aligned} \quad (4.75)$$

$$\begin{aligned} C_{Pm(\text{O}_2)} = & 3.6297 - 1.7943 \times 10^{-3} T + 0.6579 \times 10^{-5} T^2 \\ & - 0.6007 \times 10^{-8} T^3 + 0.17861 \times 10^{-11} T^4 \end{aligned} \quad (4.76)$$

$$\begin{aligned} C_{Pm(\text{CO}_2)} = & 3.912 + 1.356 \times 10^{-3} T - 1.502 \times 10^{-5} T^2 \\ & - 2.374 \times 10^{-8} T^3 + 1.056 \times 10^{-11} T^4 \end{aligned} \quad (4.77)$$

Hence, the difference in heat capacities of products and reactants is given by the equation

$$\begin{aligned} \Delta C_{Pm} = & -1.018 - 18.040 \times 10^{-3} T + 11.012 \times 10^{-5} T^2 \\ & - 28.442 \times 10^{-8} T^3 + 26.297 \times 10^{-11} T^4 \end{aligned} \quad (4.78)$$

Consequently,

$$\begin{aligned} \Delta H_m = \Delta H_{m0} + \int & (-1.018 - 18.040 \times 10^{-3} T + 11.012 \times 10^{-5} T^2 \\ & - 28.442 \times 10^{-8} T^3 + 26.297 \times 10^{-11} T^4) dT \end{aligned} \quad (4.79)$$

or

$$\begin{aligned} \Delta H_m = \Delta H_{m0} + & 1.018T - 9.020 \times 10^{-3} T^2 \\ & + 3.671 \times 10^{-5} T^3 + 7.111 \times 10^{-8} T^4 + 5.259 \times 10^{-11} T^5 \end{aligned} \quad (4.80)$$

As  $\Delta H_m$  is known at 298.15 K, it is possible to substitute that value into the preceding equation and to calculate  $\Delta H_{m0}$ :

$$\Delta H_{m0} = -392,713 \text{ J mol}^{-1} \quad (4.81)$$

Now we can write a completely explicit equation for the enthalpy of formation of  $\text{CO}_2$  as a function of the temperature:

$$\begin{aligned} \Delta H_m = & -392,713 + 1.018T - 9.020 \times 10^{-3}T^2 + 3.671 \times 10^{-5}T^3 \\ & + 7.111 \times 10^{-8}T^4 + 5.259 \times 10^{-11}T^5 \end{aligned} \quad (4.82)$$

with the result expressed in  $\text{J mol}^{-1}$ . However, this expression is valid only in the temperature range for which Equations (4.75)–(4.77) represent the heat capacities of the reactants and products (see Table 4.9; as the values for  $C$  are valid from 50 K to 400 K, any calculation for temperatures above 400 K would require another integration from 400 K to that temperature using the coefficients for the higher range). These equations are empirical equations that are fitted to experimental data in a limited temperature range. In particular,  $\Delta H_{m0}$  is not the value of  $\Delta H_m$  at 0 K.

### Arithmetic Method

A second procedure, which is fundamentally equivalent to the analytic method, involves adding suitable equations to get the desired equation and makes use explicitly of the property that  $\Delta H_m$  is a state function. For example, if we consider the freezing of water, the enthalpy of the reaction is known at  $0^\circ\text{C}$  ( $T_1$ ), but it may be required at  $-10^\circ\text{C}$  ( $T_2$ ). We can obtain the desired  $\Delta H_m$  by adding the following equations (assuming that  $C_{Pm}$  is constant over the temperature range):

$$\text{H}_2\text{O}(\text{l}, 0^\circ\text{C}) = \text{H}_2\text{O}(\text{s}, 0^\circ\text{C}), \quad \Delta H_m = -6008 \text{ J mol}^{-1} \quad (4.83)$$

$$\begin{aligned} \text{H}_2\text{O}(\text{s}, 0^\circ\text{C}) = \text{H}_2\text{O}(\text{s}, -10^\circ\text{C}), \quad \Delta H_m &= \int_{0^\circ\text{C}}^{-10^\circ\text{C}} C_{Pm}(\text{s})dT \\ &= C_{Pm}(\text{s})(T_2 - T_1) \\ &= -364 \text{ J mol}^{-1} \end{aligned} \quad (4.84)$$

$$\begin{aligned} \text{H}_2\text{O}(\text{l}, -10^\circ\text{C}) = \text{H}_2\text{O}(\text{l}, 0^\circ\text{C}), \quad \Delta H_m &= \int_{-10^\circ\text{C}}^{0^\circ\text{C}} C_{Pm}(\text{l})dT \\ &= C_{Pm}(\text{l})(T_1 - T_2) \\ &= 753 \text{ J mol}^{-1} \end{aligned} \quad (4.85)$$

$$\begin{aligned} \text{H}_2\text{O}(\text{l}, -10^\circ\text{C}) = \text{H}_2\text{O}(\text{s}, -10^\circ\text{C}), \quad \Delta H_m &= -6008 - 364 + 753 \\ &= -5619 \text{ J mol}^{-1} \end{aligned} \quad (4.86)$$



### Graphical or Numerical Methods<sup>3</sup>

If analytic equations for the heat capacities of reactants and products are unavailable, we still can carry out the integration required by Equation (4.78) by graphical or numerical methods. In essence, we replace Equation (4.79) by the expression

$$\Delta H_m \cong \Delta H_{m0} + \sum (\overline{\Delta C_{Pm}})(\Delta T) \quad (4.87)$$

where  $\overline{\Delta C_{Pm}}$  is the average value in the interval  $\Delta T$ .

### EXERCISES

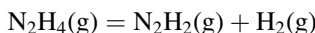
- 4.1. Calculate the differences between  $Q_P$  and  $Q_V$  in the following reactions:
  - a.  $\text{H}_2(\text{g}) + 1/2 \text{O}_2(\text{g}) = \text{H}_2\text{O}(\text{l})$  at  $25^\circ\text{C}$
  - b. Ethyl acetate + water = ethyl alcohol + acetic acid, at  $25^\circ\text{C}$
  - c. Haber synthesis of ammonia, at  $400^\circ\text{C}$
  - d.  $\text{C}_6\text{H}_{12}\text{O}_6 + 6\text{O}_2(\text{g}) = 6\text{CO}_2(\text{g}) + 6\text{H}_2\text{O}$ , at  $25^\circ\text{C}$
  - e.  $\alpha$  quartz =  $\beta$  quartz, at 846 K
- 4.2. Find the enthalpy of formation of ethyl alcohol in the International Critical Tables and the National Bureau of Standards tables (Table 4.2). Compare the respective values. Compare each of these with the value obtained from the Thermodynamic Research Center tables (Table 4.5) when combined with a value of the enthalpy of vaporization.
- 4.3. According to Schwabe and Wagner [19], the enthalpies of combustion in a constant-volume calorimeter for fumaric and maleic acids are  $-1337.21 \text{ kJ mol}^{-1}$  and  $-1360.43 \text{ kJ mol}^{-1}$ , respectively, at approximately  $25^\circ\text{C}$ .
  - a. Calculate the enthalpies of formation of these isomers.
  - b. What is the difference in enthalpy between these isomers?
- 4.4. Standard enthalpies of formation of some sulfur compounds [Reprinted with permission from Ref. (20). Copyright 1958 American Chemical Society.] are listed below, together with that for  $\text{S}(\text{g})$  from tables of the National Bureau of Standards:

Substance	$\Delta_f H^\circ_{m298.15\text{K}} / (\text{kJ mol}^{-1})$
$\text{C}_2\text{H}_5\text{-S-C}_2\text{H}_5(\text{g})$	-147.24
$\text{C}_2\text{H}_5\text{-S-S-C}_2\text{H}_5(\text{g})$	-201.92
$\text{S}(\text{g})$	278.805

From these data alone, compute  $\epsilon_{\text{S-S}}$ .

<sup>3</sup>See section A.2.

- 4.5. For  $\text{NF}_3(\text{g})$  at  $25^\circ\text{C}$ ,  $\Delta_f H_m^\circ$  is  $-124.3 \text{ kJ mol}^{-1}$  [21]. Using Table 4.8 for any necessary bond enthalpies, calculate  $\epsilon_{\text{N-F}}$ .
- 4.6. From mass spectrometric experiments [22], it is possible to compute a value of  $109 \text{ kJ mol}^{-1}$  for  $\Delta H_{m298\text{K}}^\circ$  for the reaction



Knowing in addition that  $\Delta_f H_{m298\text{K}}^\circ$  of hydrazine gas,  $\text{N}_2\text{H}_4$ , is  $95.0 \text{ kJ mol}^{-1}$ , and assuming that the structure of  $\text{N}_2\text{H}_2$  is  $\text{HN}=\text{NH}$ , calculate  $\epsilon_{\text{N=N}}$ .

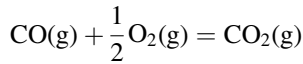
- 4.7. Taking the enthalpy of combustion of ethane as  $-1559.8 \text{ kJ mol}^{-1}$ , calculate the C–C bond enthalpy.
- 4.8. Find data for the standard enthalpies of formation of  $\text{Cl}(\text{g})$ ,  $\text{S}(\text{g})$ ,  $\text{S}_8(\text{g})$ , and  $\text{S}_2\text{Cl}_2(\text{g})$  from appropriate sources.
- Calculate the enthalpy of the S–S bond. Assume that  $\text{S}_8$  consists of eight such linkages.
  - Calculate the enthalpy of the S–Cl bond.
  - Estimate the enthalpy of formation of  $\text{SCl}_2(\text{g})$ .
- 4.9. Molar heat capacities of solid n-heptane are listed in Table A.4.
- Calculate  $H_{m,182.5 \text{ K}} - H_{m,15 \text{ K}}$  by numerical integration.
  - Calculate  $H_{m,15 \text{ K}} - H_{m,0 \text{ K}}$  by analytical integration of the Debye equation from 0 K to 15 K.
  - Calculate  $H_{m,182.5 \text{ K}} - H_{m,0 \text{ K}}$  from the results of a and b.
- 4.10. Prove the following relationships using only definitions and mathematical principles:

a. 
$$\left(\frac{\partial U}{\partial V}\right)_P = C_P \left(\frac{\partial T}{\partial V}\right)_P - P$$

b. 
$$\left(\frac{\partial U}{\partial P}\right)_V = C_V \left(\frac{\partial T}{\partial P}\right)_V$$

- 4.11. Using the equations in Exercise 10, calculate  $(\partial U_m / \partial V_m)_P$  and  $(\partial U_m / \partial P)_V$  for the special case of 1 mol of an ideal gas, for which  $PV_m = RT$ .
- 4.12. Suggest a substance, and the conditions for that substance, such that  $C_P = C_V$ , that is, for which the second term on the right side of Equation (4.61) equals zero.

- 4.13. Derive an equation for the dependence of  $\Delta H_m$  on temperature for the reaction

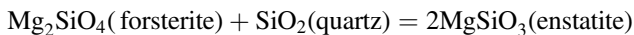


Appropriate data can be found in the tables of this chapter.

- 4.14. Enthalpies of formation of solid alloy phases can be calculated from enthalpies of solution of these phases in a suitable liquid metal. The pure metals and alloys listed below, which were all originally at 31°C, have each been dropped into liquid tin at 250°C, and the heat of this process has been measured. The results, which are reprinted with permission from Ref. 23, Copyright American Chemical Society, computed for 1 mole of material are as follows:

Phase	$\Delta H_m / (\text{J mol}^{-1})$
Ag	20418
Cd	18995
$\zeta(\text{Ag}_{0.5}\text{Cd}_{0.5})$	27447
$\gamma(\text{Ag}_{0.412}\text{Cd}_{0.588})$	27949

- a. Calculate  $\Delta_f H_m^\circ$  of the  $\zeta$  phase at 31°C.  
 b. Calculate  $\Delta_f H_m^\circ$  of the  $\gamma$  phase at 31°C.
- 4.15. Calculate the enthalpy change at 25°C for the following reaction using standard enthalpies of formation:

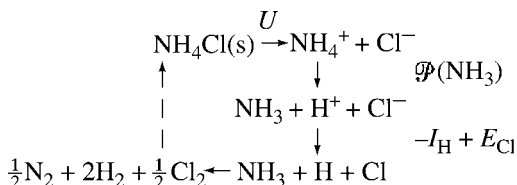


- 4.16. The “proton affinity”  $\phi$  of a substance such as  $\text{NH}_3$  is defined as the change in energy for the reaction



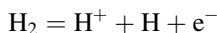
$\phi(\text{NH}_3)$  at 0 K can be computed from other thermal data through consideration of an appropriate Born–Haber cycle (all substances except  $\text{NH}_4\text{Cl}$

being gases):



in which  $U$  represents the lattice energy per mole of crystalline  $\text{NH}_4\text{Cl}$ ,  $I_{\text{H}}$  is the ionization energy of a mole of hydrogen atoms, and  $E_{\text{Cl}}$  is the electron affinity of a mole of chlorine atoms. The values of these quantities are (in  $\text{kJ mol}^{-1}$ ) 640, 1305, and 387.0, respectively. Using  $-314.2 \text{ kJ mol}^{-1}$  as the enthalpy of formation of  $\text{NH}_4\text{Cl(s)}$  and  $-45.6 \text{ kJ mol}^{-1}$  as the enthalpy of formation of  $\text{NH}_3(\text{g})$ , and finding any other quantities you need from tables in this chapter, calculate  $\varphi(\text{NH}_3)$ .

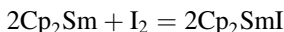
- 4.17.** The adiabatic flame temperature is the temperature that would be attained if a compound were burned completely under adiabatic conditions so that all the heat evolved would go into heating the product gases. Calculate the adiabatic flame temperature for the burning of ethane in an air mixture containing originally twice as much air as is necessary for complete combustion to  $\text{CO}_2(\text{g})$  and  $\text{H}_2\text{O}(\text{g})$ . Assume that air is composed of 20%  $\text{O}_2$  and 80%  $\text{N}_2$  by volume. In using heat capacity equations, neglect all terms containing  $T^2$  or higher powers of  $T$ . Assume also that the combustion occurs at constant pressure.
- 4.18.** Mass spectrometry is one of the experimental methods for determining bond dissociation enthalpies. The mass spectrometer can provide a measure of the appearance potential for a given reaction, that is, the threshold energy necessary to produce a particular set of particles. The appearance potential for the following reaction of  $\text{H}_2$ ,



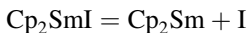
is 18.0 eV. The ionization energy of hydrogen is 13.6 eV. Calculate the bond enthalpy of  $\text{H}_2$ . (1 eV = 96.44  $\text{kJ mol}^{-1}$ )

- 4.19.** Good [24] measured at 298.15 K the standard enthalpy of combustion of  $n$ -octane(l) as  $-5470.29 \text{ kJ mol}^{-1}$  and the standard enthalpy of combustion of 2,2,3,4-tetramethyl butane(s) as  $-5451.46 \text{ kJ mol}^{-1}$ . Calculate the corresponding standard enthalpies of formation.

- 4.20.** Johnson and Steele [25] determined the standard enthalpy of combustion of  $\text{UO}_2(\text{s})$  in gaseous fluorine. The products of combustion are  $\text{UF}_6(\text{s})$  and  $\text{O}_2(\text{g})$ . The measured value of the enthalpy of combustion is  $-1112.6 \text{ kJ mol}^{-1}$ , and the standard enthalpy of formation of  $\text{UF}_6(\text{s})$  is  $-2197.7 \text{ kJ mol}^{-1}$ . Calculate the standard enthalpy of formation of  $\text{UO}_2(\text{s})$ .
- 4.21.** McDonald et al. [26] used a flowing afterglow apparatus to measure the proton and electron affinities of hypovalent ion radicals in the gas phase.
- They obtained a value of  $364 \text{ kcal mol}^{-1}$  for the proton affinity of  $(\text{CF}_3)_2\text{CH}^-$ . Calculate  $\Delta_f H_m^\circ$  for this anion, using the value of  $367.2 \text{ kcal mol}^{-1}$  for  $\Delta_f H_m^\circ$  of  $\text{H}^+(\text{g})$  and  $-326.9 \text{ kcal mol}^{-1}$  for  $\Delta_f H_m^\circ$  of  $(\text{CF}_3)_2\text{CH}_2(\text{g})$ .
  - With the results of part **a** and their determination of  $\Delta H_m^\circ$  of dissociation of  $(\text{CF}_3)_2\text{CH}^-$  to  $(\text{CF}_3)_2\text{C}^- + \text{H}^\cdot$ , equal to  $100 \text{ kcal mol}^{-1}$ , calculate  $\Delta_f H_m^\circ$  for  $(\text{CF}_3)\text{C}^-$ .
- 4.22.** Ervin et al. [27] have determined the electron affinity of the acetylide radical,  $\text{HC}\equiv\text{C}^\cdot$ , to be equal to  $2.969 \pm 0.010 \text{ eV}$  and the enthalpy of the acid dissociation of acetylene in the gas phase to be equal to  $377.8 \pm 0.6 \text{ Kcal mol}^{-1}$ . Use these data, together with the ionization potential of the hydrogen atom,  $13.595 \text{ eV}$ , to calculate the enthalpy for the dissociation of the  $\text{CH}$  bond in acetylene. The ionization potentials are properly applied at  $0 \text{ K}$ , but a good approximation is to assume that they are equal to enthalpy changes at  $298.15 \text{ K}$ , the temperature at which the enthalpy of the acid dissociation was measured.
- 4.23.** Steele et al. [28] have measured the standard enthalpy of combustion of buckminsterfullerene  $\text{C}_{60}$  with bomb calorimetry of solid samples at  $298.15 \text{ K}$ . They have found a value of  $26,033 \pm 14 \text{ kJ mol}^{-1}$ . Calculate the standard enthalpy of formation of  $\text{C}_{60}$  and the standard enthalpy of transition from graphite to  $\text{C}_{60}$ .
- 4.24.** Nolan et al. [29] have determined metal ligand bond dissociation enthalpies by titration calorimetry.
- For the reaction in toluene,

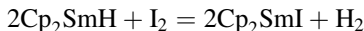


they found  $\Delta H_m = -102.4 \text{ kcal mol}^{-1}$ , where  $\text{Cp}$  is the cyclopentadienyl ligand. Use this value and other data in this chapter to calculate  $\Delta H_m$  for the reaction in toluene:

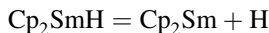


(You may assume that gas phase data may be used for reactions in toluene.)

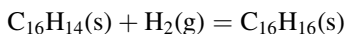
b. For the reaction in toluene,



they found  $\Delta H_{\text{m}} = -104.8 \text{ kcal mol}^{-1}$ . Use this value, the results in a, and other data in this chapter to calculate  $\Delta H_{\text{m}}$  for the reaction in toluene:



- 4.25. Chirico et al. [30] have determined the standard molar enthalpies of combustion at 298.15 K of 4,5,9,10-tetrahydropyrene ( $\text{C}_{16}\text{H}_{14}$ ),  $-8,322.18 \pm 1.21 \text{ kJ mol}^{-1}$ , and 1,2,3,6,7,8-hexahydropyrene ( $\text{C}_{16}\text{H}_{16}$ ),  $-8,538.75 \pm 1.74 \text{ kJ mol}^{-1}$ . Calculate  $\Delta H_{\text{m}}^{\circ}$  for the reaction



- 4.26. Forray et al. [31] determined the enthalpy of formation of the mineral yavapaiite  $\text{KFe}(\text{SO}_4)_2$  by high-temperature oxide melt solution calorimetry. Yavapaiite was dissolved in molten  $3\text{Na}_2\text{O} \cdot 4\text{MoO}_4$ . The enthalpy of solution for yavapaiite was measured as well as the corresponding values for  $\text{Fe}_2\text{O}_3$ ,  $\text{K}_2\text{SO}_4$ , and  $\text{SO}_3$ , although the products of solution of yavapaiite were  $\text{K}_2\text{O}$ ,  $\text{Fe}_2\text{O}_3$ , and  $\text{SO}_3$ , because the corresponding experiment could not be carried out for  $\text{K}_2\text{O}$ . The values obtained were as follows:  $\Delta H$  of solution for yavapaiite at 298 K to solution in the melt at 973 K is  $-2042.8 \pm 6.2 \text{ kJ mol}^{-1}$ ;  $\Delta H$  of solution for  $\text{Fe}_2\text{O}_3$  under the same conditions is  $-826.2 \pm 1.3 \text{ kJ mol}^{-1}$ ,  $\Delta H$  of solution for  $\text{SO}_3$  under the same conditions is  $-395.7 \pm 0.7 \text{ kJ mol}^{-1}$ , and  $\Delta H$  of solution for  $\text{K}_2\text{SO}_4$  to yield  $\text{K}_2\text{O}$  and  $\text{SO}_3$  under the same conditions is  $-1437.7 \pm 0.5 \text{ kJ mol}^{-1}$ . Use these data along with any values needed from Table 4.4 to calculate  $\Delta_f H_{\text{m}}^{\circ}$  for yavapaiite.
- 4.27. Corrazana et al. [32] have measured the enthalpy of inclusion of rimantidine, an adamantyl compound, into several cyclodextrins. The values of  $\Delta H$  for inclusion of rimantidine in  $\beta$  cyclodextrin, 6-amino  $\beta$  cyclodextrin, and 3-amino  $\beta$  cyclodextrin, respectively, are  $-28.60 \pm 0.16 \text{ kJ mol}^{-1}$ ,  $-25.02 \pm 0.13 \text{ kJ mol}^{-1}$ , and  $-17.29 \pm 0.18 \text{ kJ mol}^{-1}$ . Calculate the values of  $\Delta H$  for transfer of rimantidine from each cyclodextrin to each of the others. We can write the equations for the inclusion process as:
- $\beta \text{ cyclo} + \text{rimantidine} = \text{complex 1}$
  - 6-amino  $\beta \text{ cyclo} + \text{rimantidine} = \text{complex 2}$
  - 3-amino  $\beta \text{ cyclo} + \text{rimantidine} = \text{complex 3}$

## REFERENCES

1. D. D. Wagman, The NBS tables of chemical thermodynamic properties, *J. Phys. Chem. Ref. Data* **11**, Supplement No. 2, (1982), pp. 2–7, pp. 2–14. Similar data can also be found listed by compound at <http://webbook.nist.gov/chemistry/>, the Chemistry WebBook of the National Institute of Science and Technology.
2. E. F. G. Herington, Thermodynamic quantities, thermodynamic data, and their uses, in *Chemical Thermodynamics, A Specialist Periodical Report* Vol. 1, M. L. McGlashan, ed., The Chemical Society London, 1973.
3. R. C. Wilhoit and K. N. Marsh, *Int. J. Thermophysics* **20**, 247 (1999); M. Frenkel, R. D. Chirico, V. D. Diky, Q. Dong, S. Frenkel, P. R. Franchois, D. L. Embry, T. L. Teague, K. N. Marsh, and R. C. Wilhoit, *J. Chem. Eng. Data* **48**, 2 (2003), and succeeding and earlier publications.
4. M. Frenkel, K. N. Marsh, R. C. Wilhoit, G. J. Kabo, and G. N. Roganov, *Thermodynamics of Organic Compounds in the Gas State*, Vol. II, Thermodynamics Research Center, College Station, TX, 1994, pp. 529–569.
5. L. A. Curtiss, K. Raghavachari, P. C. Redfern, V. Rassolov, and J. A. Pople, *J. Chem. Phys.* **109**, 7764 (1998); L. A. Curtiss, and K. Raghavachari, *Theore. Chem. Accounts* **108**, 61 (2002); See also, D. W. Rogers and F. J. McLaafferty, *J. Org. Chem.* **66**, 1157 (2001).
6. F. D. Bichowsky and F. D. Rossini, *The Thermochemistry of Chemical Substances*, Reinhold New York, 1936. The authors report results at 18°C instead of the already more accepted 25°C because a major source of the experimental data they use is the classic work of J. Thomsen, *Thermochemische Untersuchungen*, Vol. I-IV, J. A. Barth, Leipzig, 1882–86.
7. P. Hawtin, J. B. Lewis, N. Moul, and R. H. Phillips, *Proc. Roy. Soc.* **261**, 9 (1966).
8. A. Shrake, A. Ginsburg, and H. K. Schachman, *J. Biol. Chem.* **256**, 5005 (1981)
9. D. W. Rogers, *Computational Chemistry Using the PC*, Chapter 6, VCH Publishers, New York, 1994.
10. G. L. Humphrey and E. G. King, *J. Am. Chem. Soc.* **74**, 2041 (1952).
11. D. R. Torgerson and Th. G. Sahama, *J. Am. Chem. Soc.* **70**, 2156 (1948).
12. G. B. Kistiakowsky and E. R. Van Artsdalen, *J. Chem. Phys.* **12**, 469 (1944).
13. J. H. Hildebrand, J. M. Prausnitz, and R. L. Scott, *Regular and Related Solutions*, Van Nostrand Reinhold Co., New York, 1970, pp. 40–41; J. S. Rowlinson and F. L. Swinton, *Liquids and Liquid Mixtures*, 3rd ed., Butterworth Scientific, London, 1982, pp. 23–24, 264.
14. C. T. Mortimer, *Reaction Heats and Bond Strengths*, Addison-Wesley, Reading, MA, 1963; G. J. Janz, *Thermodynamic Properties of Organic Compounds*, Chapter 7, rev. ed., Academic Press, New York, 1967; S. W. Benson, *J. Chem. Ed.* **42**, 502 (1965); J. B. Pedley, R. D. Naylor, and S. P. Kirby, *Thermochemical Data of Organic Compounds*, 2nd ed., Chapman Hall, London, 1986.
15. A method has been described [B. L. Crawford, Jr., and R. G. Parr, *J. Chem. Phys.* **16**, 233 (1948)] by means of which one can proceed directly from spectroscopic data to an empirical equation of the form of Equation (4.67).
16. Deviations from the  $T^3$  law and their significance have been discussed by K. Clusius and L. Schachinger, *Z. Naturforsch.* **2a**, 90 (1947), and by G. L. Pickard and F. E. Simon, *Proc. Phys. Soc.* **61**, 1 (1948).

17. Low temperature heat capacity experiments with buckminsterfullerene, C<sub>60</sub>, indicate that this substance does not follow the Debye equation, but requires a more complex model. See W. P. Beyermann, et al. *Phys. Rev. Lett.* **68**, 2046 (1992).
18. M. Zábanský, V. Růžička Jr., V. Majer, and E. S. Domalski, Heat capacity of liquids: Vols. I and II *J. Phys. Chem. Ref. Data*, Monograph No. 6, 1996.
19. K. Schwabe and W. Wagner, *Chem. Ber.* **91**, 686 (1958).
20. N. Hubbard, D. R. Douslin, J. P. McCullough, D. W. Scott, S. S. Todd, J. F. Messerly, I. A. Hossenlop, A. George, and G. Waddington, *J. Am. Chem. Soc.* **80**, 3547 (1958).
21. G. T. Armstrong, S. Marantz, and C. F. Coyle, *J. Am. Chem. Soc.* **81**, 3798 (1959).
22. S. N. Foner and R. L. Hudson, *J. Chem. Phys.* **28**, 719 (1958).
23. P. D. Anderson, *J. Am. Chem. Soc.* **80**, 3171 (1958).
24. W. D. Good, *J. Chem. Thermodynamics* **4**, 709 (1972).
25. G. K. Johnson and W. V. Steele, *J. Chem. Thermodynamics* **13**, 717 (1981).
26. R. N. McDonald, A. K. Chowdhury, and W. D. McGhee, *J. Am. Chem. Soc.* **106**, 4112 (1984).
27. K. M. Ervin, et al., *J. Am. Chem. Soc.* **112**, 5750 (1990).
28. W. V. Steele, et al., *J. Phys. Chem.* **96**, 4731 (1992).
29. S. P. Nolan, D. Stern, and T. J. Marks, *J. Am. Chem. Soc.* **111**, 7844 (1989).
30. R. D. Chirico, S. E. Knipmeyer, A. Nguyen, N. K. Smith, and W. V. Steele, *J. Chem. Thermodynamics* **25**, 729 (1993).
31. F. L. Forray, C. Drouet, and A. Navrotsky, *Geochim. Cosmochim. Acta* **69**, 2133 (2005).
32. J. Corrazana, A. Jover, F. Mejjide, and V. H. Soto, *J. Phys. Chem.* **109**, 9719 (2005).





## CHAPTER 5

---

# APPLICATION OF THE FIRST LAW TO GASES

---

As a prelude to the development of the second law of thermodynamics, we will find it useful to consider the information obtainable for the behavior of gases by the application of the first law of thermodynamics and the associated definitions that have been developed so far. In addition, the relationships developed for gases that are based on the first law will be useful in developing the second law of thermodynamics and in applying the second law to specific systems. As the behavior of many gases at low pressure can be approximated by the simple equation of state for the ideal gas, and as the ideal equation of state describes accurately the behavior of real gases at the limit of zero pressure, we will begin our discussion with a consideration of ideal gases.

### 5.1 IDEAL GASES

#### Definition

An ideal gas is one (1) that obeys the equation of state

$$PV = nRT \quad (5.1)$$

in which  $n$  is the amount of matter in units of moles and  $R$  is a universal constant; and (2) for which the energy  $U$  is a function of the temperature

only; that is,

$$\left(\frac{\partial U}{\partial V}\right)_T = \left(\frac{\partial U}{\partial P}\right)_T = 0 \quad (5.2)$$

It follows from Equation (5.2) that if an ideal gas undergoes any isothermal transformation, its energy remains fixed.<sup>1</sup>

Equation (5.1) can be derived from the empirical laws of Boyle and Charles by using the total differential. Boyle's law can be expressed by the relationship

$$V = \frac{nk_T}{P} \quad (T \text{ constant, } n \text{ constant}) \quad (5.3)$$

or

$$\left(\frac{\partial V}{\partial P}\right)_T = -\frac{nk_T}{P^2} \quad (5.4)$$

in which  $k_T$  is a constant at a fixed temperature. Similarly, Charles's law can be expressed by relationship

$$V = nk_P T \quad (P \text{ constant, } n \text{ constant}) \quad (5.5)$$

or

$$\left(\frac{\partial V}{\partial T}\right)_P = nk_P \quad (5.6)$$

If we consider the total differential of the volume  $V = f(T, P)$ , we obtain

$$dV = \left(\frac{\partial V}{\partial T}\right)_P dT + \left(\frac{\partial V}{\partial P}\right)_T dP \quad (5.7)$$

Equations (5.4) and (5.6) can be used to substitute for the partial derivatives in Equation (5.7) to obtain

$$dV = nk_P dT - \frac{nk_T}{P^2} dP \quad (5.8)$$

<sup>1</sup>We shall show as an exercise in Chapter 6, that Equation (5.2) follows from the second law of thermodynamics and does not have to be a part of the definition of an ideal gas.

The constants  $k_P$  and  $k_T$  can be replaced by their values from Equations (5.3) and (5.5):

$$dV = \frac{V}{T} dT - \frac{V}{P} dP \quad (5.9)$$

Rearranging Equation (5.9), we obtain

$$\frac{dV}{V} + \frac{dP}{P} = \frac{dT}{T} \quad (5.10)$$

which can be integrated to give

$$\ln V + \ln P = T + \ln k' \quad (5.11)$$

or

$$PV = k'T \quad (5.12)$$

in which  $k'$  is a constant of integration. If we identify  $k'$  with  $nR$ , we have Equation (5.1), the ideal gas law. The identification of  $k'$  with  $nR$  is derived from the empirical content of Avogadro's law, that the  $PV$  product of a gas at constant temperature is proportional to the amount of matter, which is expressed in moles.

### Enthalpy as a Function of Temperature Only

We can show that the enthalpy, as well as the internal energy, is constant in any isothermal change of an ideal gas as follows:

$$H = U + PV \quad (4.3)$$

and

$$\left(\frac{\partial H}{\partial V}\right)_T = \left(\frac{\partial U}{\partial V}\right)_T + \left[\frac{\partial(PV)}{\partial V}\right]_T \quad (5.13)$$

But from Equations (5.1) and (5.2), it is evident that each term on the right side of Equation (5.13) is zero. Consequently

$$\left(\frac{\partial H}{\partial V}\right)_T = 0 \quad (5.14)$$

By an analogous procedure, it also can be shown that

$$\left(\frac{\partial H}{\partial P}\right)_T = 0 \quad (5.15)$$

### Relationship Between $C_P$ and $C_V$

In Chapter 4 the following expression [Equation (4.61)] was shown to be a general relationship between the heat capacity at constant pressure and the heat capacity at constant volume:

$$C_P = C_V + \left[ P + \left( \frac{\partial U}{\partial V} \right)_T \right] \left( \frac{\partial V}{\partial T} \right)_P$$

For 1 mole of an ideal gas

$$\left( \frac{\partial U_m}{\partial V_m} \right)_T = 0 \quad (5.16)$$

and

$$\left( \frac{\partial V_m}{\partial T} \right)_P = \frac{R}{P} \quad (5.17)$$

The substitution of Equations (5.15) and (5.16) into Equation (4.61) leads to the familiar expression

$$C_{Pm} = C_{Vm} + R \quad (5.18)$$

### Calculation of the Thermodynamic Changes in Expansion Processes

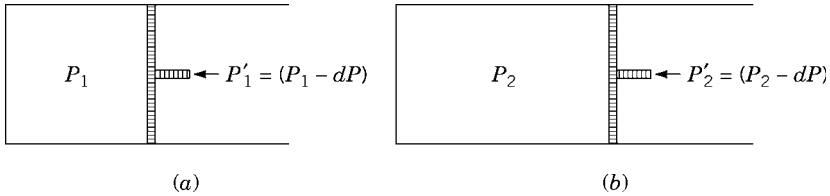
**Isothermal.** As pointed out in Equation (3.6), work performed in a finite gaseous expansion is given by the expression

$$W = - \int_{V_1}^{V_2} P' dV \quad (3.6)$$

in which  $P'$  is the external pressure.

Any finite expansion that occurs in a finite time is irreversible. A reversible expansion can be approximated as closely as desired, and the values of the thermodynamic changes can be calculated for the limiting case of a reversible process. In the limiting case, the process must be carried out infinitely slowly so that the pressure  $P$  is always a well-defined quantity. A reversible process is a succession of states, each of which is an equilibrium state, in which the temperature and pressure have well-defined values; such a process is also called a quasi-static process.

As the actual work done approaches the reversible work, the pressure  $P$  of the gas and the external pressure  $P'$  differ infinitesimally, and the direction of change can be



**Figure 5.1.** Schematic representation of an isothermal reversible expansion from pressure  $P_1$  to pressure  $P_2$ . The external pressure is maintained only infinitesimally less than the internal pressure.

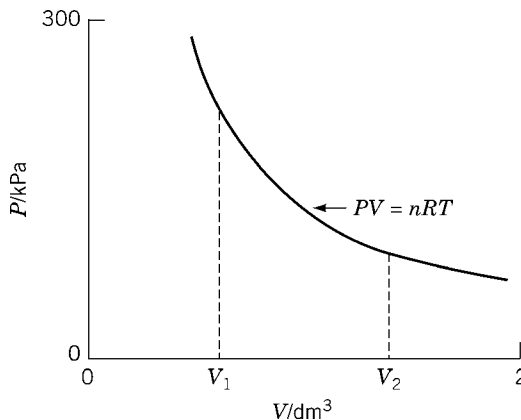
reversed by an infinitesimal change in the external pressure. Under these conditions,  $P'$  is essentially equal to  $P$ ; thus, Equation (3.6) can be rewritten as

$$W = - \int_{V_1}^{V_2} P dV \text{ (reversible)} \quad (5.19)$$

Because the reversible process is a succession of equilibrium states,  $P$  is given by the equation of state, which is Equation (5.1) for an ideal gas. Substituting from Equation (5.1) into Equation (5.19), we obtain

$$W = - \int_{V_1}^{V_2} \frac{nRT}{V} dV = -nRT \ln \frac{V_2}{V_1} \quad (5.20)$$

for the case in which the gas is in thermal equilibrium with the surroundings, which are maintained at a constant temperature  $T$ . The reversible expansion can be visualized as in Figures 5.1 and 5.2. The curve in Figure 5.2 represents the succession of



**Figure 5.2.** The path in  $P$ - $V$  space taken in a reversible isothermal expansion of an ideal gas. The area between the dashed lines under the curve represents the negative of the work performed.

equilibrium states in the expansion, and the area under the curve between the dashed lines is the negative of the work performed in an expansion from  $V_1$  to  $V_2$ .

As the process is isothermal, and as  $U$  depends only on the temperature,

$$\Delta U = 0 \quad (5.21)$$

With this information and the use of the first law of thermodynamics, we can calculate the heat absorbed from the surroundings in the process:

$$Q = \Delta U - W = nRT \ln \frac{V_2}{V_1} \quad (5.22)$$

Finally,  $\Delta H$  also is equal to zero, because

$$\Delta H = \Delta U + \Delta(PV) = 0 + \Delta(nRT) = 0 \quad (5.23)$$

If the gas is allowed to expand against zero external pressure (a free expansion; Fig. 5.3), then from Equation (3.6)  $W$  equals zero. Although the temperature of the gas may change during the free expansion (indeed, the temperature is not a well-defined quantity during an irreversible change), the temperature of the gas will return to that of the surroundings with which it is in thermal contact when the system has reached a new equilibrium. Thus, the process can be described as isothermal, and for the gas,

$$W = 0 \quad (5.24)$$

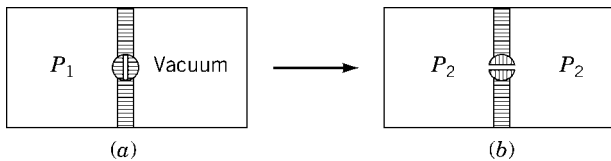
$$\Delta U = 0 \quad (5.25)$$

and

$$Q = \Delta U - W = 0$$

$$\Delta H = \Delta U + \Delta(PV) = 0 \quad (5.26)$$

In an intermediate irreversible expansion in which the external pressure is not zero but is less than the pressure of the gas by a finite amount, some work would be



**Figure 5.3.** Schematic representation of a free expansion. A small valve separating the two chambers in (a) is opened so that the gas can rush in from left to right. The initial volume of the gas is  $V_1$ , and the final volume is  $V_2$ .

obtained. However, because  $P'$  is always less than  $P$ , the work performed always will be less in magnitude than that for the reversible expansion. That is,

$$0 < |W| < \left| -nRT \ln \frac{V_2}{V_1} \right| \quad (5.27)$$

because  $W$  is negative in an expansion by our convention.

For an ideal gas when isothermal conditions are maintained as in Equation (5.21) and  $Q$  is given by the first law as

$$Q = \Delta U - W = -W \quad (5.28)$$

Then

$$0 < Q < nRT \ln \frac{V_2}{V_1} \quad (5.29)$$

The enthalpy change is calculated from the relationship

$$\Delta H = \Delta U + \Delta(PV) = 0 \quad (5.30)$$

**TABLE 5.1. Thermodynamic Quantities for Isothermal Changes in an Ideal Gas**

Expansion	Compression	Cycle
<i>Reversible</i>		
$W = -nRT \ln \frac{V_2}{V_1}$	$W = -nRT \ln \frac{V_1}{V_2}$	$W = 0$
$\Delta U = 0$	$\Delta U = 0$	$\Delta U = 0$
$Q = nRT \ln \frac{V_2}{V_1}$	$Q = nRT \ln \frac{V_1}{V_2}$	$Q = 0$
$\Delta H = 0$	$\Delta H = 0$	$\Delta H = 0$
<i>Free</i>		
$W = 0$	$W = P'(V_1 - V_2) > nRT \ln \frac{V_1}{V_2}$	$W = -P'(V_1 - V_2) > 0$
$\Delta U = 0$	$\Delta U = 0$	$\Delta U = 0$
$Q = 0$	$Q = P'(V_1 - V_2) < nRT \ln \frac{V_1}{V_2}$	$Q = P'(V_1 - V_2) < 0$
$\Delta H = 0$	$\Delta H = 0$	$\Delta H = 0$
<i>Intermediate</i>		
$0 <  W  < \left  -nRT \ln \frac{V_2}{V_1} \right $	$W = P'(V_1 - V_2) > nRT \ln \frac{V_1}{V_2}$	$W > 0$
$\Delta U = 0$	$\Delta U = 0$	$\Delta U = 0$
$0 < Q < nRT \ln \frac{V_2}{V_1}$	$Q = P'(V_1 - V_2) < nRT \ln \frac{V_1}{V_2}$	$Q < 0$
$\Delta H = 0$	$\Delta H = 0$	$\Delta H = 0$



The thermodynamic changes for reversible, free, and intermediate expansions are compared in the first column of Table 5.1. This table emphasizes the difference between an exact differential and an inexact differential. Thus,  $U$  and  $H$ , which are state functions whose differentials are exact, undergo the same change in each of the three different paths used for the transformation. They are thermodynamic properties. However, the work and heat quantities depend on the particular path chosen, even though the initial and final values of the temperature, pressure, and volume, respectively, are the same in all these cases. Thus, heat and work are not thermodynamic properties; rather, they are energies in transfer between system and surroundings.

It is permissible to speak of the energy (or enthalpy) of a system, even though we can measure only differences in these functions, because their differences are characteristic of the initial and final states and are independent of the path. In contrast, heat and work are not properties of the system alone but also of the path followed when the system goes from one state to another. Because the work or heat obtained in going from State A to State B may be different from that required to return it from State B to State A, it is misleading to speak of the work or heat contained in the system.

If we consider the reverse of the changes described in the first column of Table 5.1, we can examine the net results of a complete cycle. For a reversible isothermal compression from  $V_2$  to  $V_1$ , the work performed is, according to Equation (3.6)

$$W = - \int_{V_2}^{V_1} P dV$$

$$= - \int_{V_2}^{V_1} \frac{nRT}{V} dV \quad (5.31)$$

$$= -nRT \ln \frac{V_1}{V_2} \quad (5.32)$$

As we have observed,  $\Delta U = 0$  and

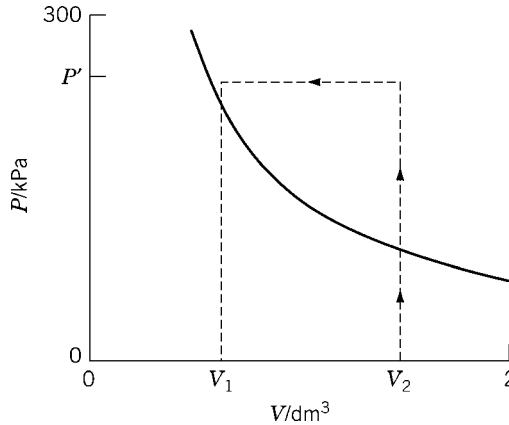
$$Q = -W = nRT \ln \frac{V_1}{V_2} \quad (5.33)$$

Similarly,

$$\Delta H = \Delta U + \Delta(PV) = 0 \quad (5.34)$$

for both expansion and compression.

No compression equivalent to a free expansion exists. We shall consider that the free expansion is reversed by an irreversible compression at a constant external pressure  $P'$  that is greater than the final pressure of the gas, as shown in Figure 5.4.



**Figure 5.4.** The irreversible compression at pressure  $P'$  used to return a gas to its initial state after a free expansion or an intermediate expansion. The area bounded by dashed lines represents the negative of the work performed.

Thus,

$$W = - \int_{V_2}^{V_1} P' dV \quad (5.35)$$

and the work performed in the irreversible compression is a greater positive quantity than the work performed in the reversible compression. Again  $\Delta U = 0$ , so

$$Q = -W = P'(V_1 - V_2) < nRT \ln \frac{V_1}{V_2} \quad (5.36)$$

and the heat lost to the surroundings, a negative quantity, is greater in magnitude than in the reversible compression. As in the reversible compression,

$$\Delta H = \Delta U + \Delta(PV) = 0 \quad (5.37)$$

As no meaningful distinction exists in a compression process between the free and the intermediate expansion, the reverse of the intermediate irreversible expansion can be chosen to be the same as the reverse of the free expansion. The work performed in the intermediate expansion is less in magnitude than the reversible work of expansion. Even if the compression were carried out reversibly, the work performed on the gas would be numerically equal (but opposite in sign) to that performed by the gas in the reversible expansion. Hence, the work performed in the compression is greater in magnitude than the work obtained in the expansion, so the net work in the cycle is positive; that is, work is performed by the surroundings on the system. Similarly, the heat liberated on compression is greater in magnitude than the heat absorbed during expansion; thus, the net heat exchanged is negative, and heat is transferred from the system to the surroundings.

Table 5.1 summarizes the thermodynamic changes in the ideal gas for expansions, compressions, and the complete cycles, all at constant temperature. For both the reversible and the irreversible changes in the ideal gas,  $\Delta U$  and  $\Delta H$  are zero for the complete cycle, because the system has been restored to its initial state and  $U$  and  $H$  are state functions. In contrast,  $Q$  and  $W$  for the cycle depend on the way in which the change is carried out.  $Q$  and  $W$  are zero for the reversible cycle, which thereby indicates that for a reversible cycle, the *surroundings*, as well as the system, return to their initial state. For the irreversible cycles,  $Q$  and  $W$  are not zero. A net amount of work has been performed by the surroundings on the system, and a net amount of heat has been transferred to the surroundings from the system. It is this change in the surroundings that is characteristic of irreversible cycles and of all real processes, and that will be important in our consideration of the second law of thermodynamics.

Some critical studies of the treatment of irreversible work have been discussed and extended by G. L. Bertrand [1].

**Adiabatic.** By definition, an adiabatic expansion is one that is not accompanied by a transfer of heat. Therefore

$$DQ = 0 \quad (5.38)$$

It follows from the definition of  $U$  [Equation (3.11)] that

$$dU = DW = dW \text{ (adiabatic)} \quad (5.39)$$

This equality then can be used to specify more explicitly the work performed, because if  $\Delta U$  is known,  $W$  is obtained immediately. For an ideal gas,  $\Delta U$  in the adiabatic expansion can be obtained by the following procedure.

If we consider the energy as a function of temperature and volume,  $U = f(T, V)$ , we can write an equation for the total differential [Equation (4.59)]:

$$dU = \left(\frac{\partial U}{\partial T}\right)_V dT + \left(\frac{\partial U}{\partial V}\right)_T dV \quad (4.59)$$

Because we are dealing with an ideal gas, from Equation (5.2),

$$\left(\frac{\partial U}{\partial V}\right)_T = 0 \quad (5.40)$$

Hence, Equation (4.59) can be reduced to

$$dU = \left(\frac{\partial U}{\partial T}\right)_V dT = C_V dT = dW \quad (5.41)$$

Then the work performed  $W$  and the energy change  $\Delta U$  can be obtained by integrating Equation (5.39):

$$W = \int_{T_1}^{T_2} C_V dT = \Delta U \quad (5.42)$$

Because  $dU$  is an exact differential and  $(\partial U/\partial V)_T$  is equal to zero, the cross-derivative property of the exact differential leads to the conclusion that  $(\partial C_V/\partial V)_T$  is equal to zero, so  $C_V$  is a function of  $T$  only.

To calculate  $\Delta H$ , we use Equation (5.15), which is valid for an ideal gas,

$$\left(\frac{\partial H}{\partial P}\right)_T = 0 \quad (5.15)$$

so that

$$dH = \left(\frac{\partial H}{\partial T}\right)_P dT = C_P dT \quad (5.43)$$

and

$$\Delta H = \int_{T_1}^{T_2} C_P dT \quad (5.44)$$

So far we have not specified whether the adiabatic expansion under consideration is reversible. Equations (5.40), (5.42), and (5.44) for the calculation of the thermodynamic changes in this process apply to the reversible expansion, the free expansion, or the intermediate expansion, so long as we are dealing with an ideal gas. However, the numerical values of  $W$ ,  $\Delta U$ , and  $\Delta H$  will not be the same for each of the three types of adiabatic expansion because  $T_2$ , the final temperature of the gas, will depend on the type of expansion, even though the initial temperature is identical in all cases.

If we consider the free expansion, it is apparent from Equation (5.43) that, because no work is performed, no change in temperature occurs; that is,  $T_2 = T_1$ . Thus,  $\Delta U$  and  $\Delta H$  also must be zero for this process. A comparison with the results for a free expansion in Table 5.1 shows that an adiabatic free expansion and an isothermal free expansion are two different names for the same process.

For the reversible adiabatic expansion, we can see from Equation (5.42) that the final temperature  $T_2$  must be less than  $T_1$ , because  $W$  is negative and  $C_V$  is always positive. Thus, the adiabatic reversible expansion is accompanied by a temperature drop, and  $W$ ,  $\Delta U$ , and  $\Delta H$  can be calculated from the measured initial and final temperatures using Equations (5.42) and (5.43).

For an irreversible adiabatic expansion in which some work is performed, the work performed is less in magnitude than that in the reversible process because the external pressure is less than the pressure of the gas by a finite amount. Thus, if the final volume  $V_2$  is the same as that in the reversible process,  $T_2$  will not be as low in

the actual expansion because, according to Equation (5.44), the value of the integral will be less than for the reversible expansion. Similarly, from Equations (5.42) and (5.44),  $\Delta U$  and  $\Delta H$ , respectively, also must be numerically smaller in the intermediate expansion than in the reversible one.

The three types of adiabatic expansions are summarized in Table 5.2.

For the reversible adiabatic expansion, a definite expression can be derived to relate the initial and final temperatures to the respective volumes or pressures if we assume that the heat capacity is independent of temperature. This assumption is exact at all temperatures for monatomic gases and above room temperature for diatomic gases. Again we start with Equation (5.39). Recognizing the restriction of reversibility, we obtain

$$dU = dW = -PdV \tag{5.45}$$

As we are dealing with an ideal gas, Equation (5.40) is valid. Substitution from Equation (5.41) into Equation (5.45) leads to

$$C_V dT = -PdV \tag{5.46}$$

For an ideal gas, from Equation (5.1),  $P = nRT/V$  and  $C_V$  equals  $nC_{Vm}$ . Thus, Equation (5.46) becomes

$$nC_{Vm}dT = \frac{nRT}{V}dV \tag{5.47}$$

Separating the variables, we obtain

$$\frac{C_{Vm}}{T}dT = -\frac{R}{V}dV \tag{5.48}$$

**TABLE 5.2. Thermodynamic Changes in Adiabatic Expansions of an Ideal Gas**

Reversible	Free	Intermediate
$V_1$	$V_1$	$V_1$
$V_2$	$V_2$	$V_2$
$W = \int_{T_1}^{T_2} C_V dT < 0$	$W' = \int_{T_1}^{T_2'} C_V dT = 0$	$W'' = \int_{T_1}^{T_2''} C_V dT < 0$
$\therefore T_2 < T_1$	$\therefore T_2' = T_1$	$\therefore T_2'' = T_1$
$\Delta U = \int_{T_1}^{T_2} C_V dT < 0$	$\Delta U' = 0$	$\Delta U'' = \int_{T_1}^{T_2''} C_V dT < 0$
$\Delta H = \int_{T_1}^{T_2} C_P dT < 0$	$\Delta H' = 0$	$\Delta H'' = \int_{T_1}^{T_2''} C_P dT < 0$
	$T_2 < T_2'' < T_2' = T_1$	
	$W < W'' < W' = 0$	
	$\Delta U < \Delta U'' < \Delta U' = 0$	
	$ \Delta U  >  \Delta U''  >  \Delta U'  = 0$	
	$\Delta H < \Delta H'' < \Delta H' = 0$	

which can be integrated within definite limits when  $C_{V_m}$  is constant to give

$$C_{V_m} \ln \frac{T_2}{T_1} = -R \ln \frac{V_2}{V_1} \quad (5.49)$$

This equation can be converted to

$$\left(\frac{T_2}{T_1}\right)^{C_{V_m}} = \left(\frac{V_2}{V_1}\right)^{-R} = \left(\frac{V_1}{V_2}\right)^R$$

or

$$\frac{T_2}{T_1} = \left(\frac{V_1}{V_2}\right)^{R/C_{V_m}} \quad (5.50)$$

Hence

$$T_2 V_2^{R/C_{V_m}} = T_1 V_1^{R/C_{V_m}} \quad (5.51)$$

Equation (5.51) states that the particular temperature–volume function shown is constant during a reversible adiabatic expansion. Hence we can write

$$TV^{R/C_{V_m}} = \text{constant} \quad (5.52)$$

or

$$VT^{C_{V_m}/R} = \text{constant}' \quad (5.53)$$

Any one of the Equations (5.51) through (5.53) can be used to calculate a final temperature from the initial temperature and the observed volumes.

If we measure pressures instead of temperatures, it is possible to use the following equation instead:

$$PV^{C_{P_m}/C_{V_m}} = \text{constant}'' \quad (5.54)$$

Equation (5.54) can be derived from Equation (5.53) by substituting from the equation of state for the ideal gas [2]<sup>2</sup>.

We can see from Equation (5.52) that the final temperature  $T_2$  in the reversible adiabatic expansion is less than  $T_1$ , because  $V_1$  is less than  $V_2$  and both  $R$  and  $C_V$  are positive numbers. Thus, the adiabatic reversible expansion is accompanied by a temperature drop, which can be calculated from the measured initial and final volumes or pressures. If we know the initial and final temperatures, we can calculate  $W$ ,  $\Delta U$ , and  $\Delta H$  by substitution into Equations (5.42) and (5.44).

<sup>2</sup>Equation (5.53) can be derived from Boyle's law and from the definitions of  $C_P$  and  $C_V$  without assuming the validity of the first law of thermodynamics. See Ref. [2].

For an irreversible adiabatic expansion in which some work is performed, the work performed is less in magnitude than that in the reversible process because the external pressure is less than the pressure of the gas by a finite amount. Thus, if the final volume is the same as in the reversible process, the final temperature will not be as low in the irreversible process, because, according to Equation (5.47), the temperature drop depends directly on the work performed by the expanding gas. Similarly, from Equations (5.42) and (5.44),  $\Delta U$  and  $\Delta H$ , respectively, also must be numerically smaller in the intermediate expansion than in the reversible expansion. In the adiabatic expansion, from a common set of initial conditions to the same final volume, the values of  $\Delta U$  and  $\Delta H$ , as well as the values of the work performed, seem to depend on the path (see summary in Table 5.2). At first glance, such behavior seems to contradict the assumption that  $U$  and  $H$  are state functions. Careful consideration shows that the difference occurs because the end-points of the three paths are different. Even though the final volume can be made the same, the final temperature depends on whether the expansion is free, reversible, or intermediate (Table 5.2).

## 5.2 REAL GASES

The isotherms for real gases are unlike the isotherm for an ideal gas shown in Figure 5.2 except for temperatures above the critical temperature, as illustrated in Andrews's isotherms for  $\text{CO}_2$  shown in Figure 5.5. He suggested the term "critical" for the state at  $T_c$ ,  $P_c$ , and  $V_c$ .

### Equations of State

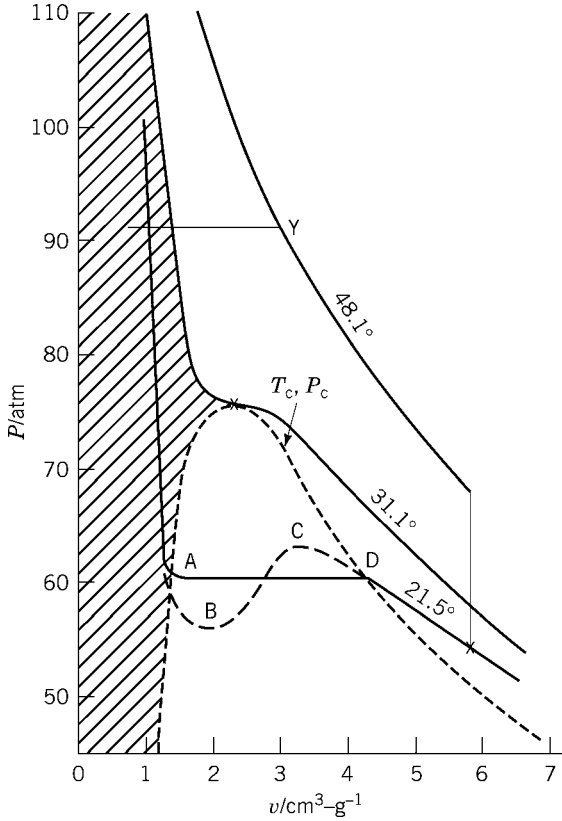
Numerous representations have been used to describe the isotherms in Figure 5.5. Some representations, such as the *Van der Waals equation*, are semi-empirical, with the form suggested by theoretical considerations, whereas others, like the *virial equation*, are simply empirical power series expansions. Whatever the description, a good measure of the deviation from ideality is given by the value of the *compressibility factor*,  $Z = (PV_m)/(RT)$ , which equals 1 for an ideal gas.

### Semi-Empirical Equations

*Van der Waals Equation.* The van der Waals equation was one of the first introduced to describe deviations from ideality [4]. The argument behind the equation is discussed adequately in elementary textbooks. Usually, it is stated in the form

$$\left(P + \frac{a}{V_m^2}\right)(V_m - b) = RT \quad (5.55)$$

in which  $V_m$  is the volume per mole and  $a$  and  $b$  are constants. Because the critical isotherm, as shown in Figure 5.5, exhibits a horizontal tangent and an inflection point



**Figure 5.5.** Isotherms for  $\text{CO}_2$  taken from the work of Andrews [3]. The shaded area indicates the region of stability of a one-phase liquid system. Liquid and vapor exist together at equilibrium under the dashed curve. Above the critical isotherm,  $31.1^\circ\text{C}$ , no distinction exists between liquid and gas. Andrews suggested that the term “vapor” be used only to represent the region to the right of the dashed curve below the critical temperature. The dashed curve ABCD represents the van der Waals equation. (By permission, from J. R. Partington, *An Advanced Treatise on Physical Chemistry*, Vol. 1, Longman Group, Ltd., London, 1949, p. 628.)

at the critical point, we can use the original equation, together with the two conditions:

$$\left(\frac{\partial P}{\partial V_m}\right)_{T_c} = 0$$

and

$$\left(\frac{\partial^2 P}{\partial V_m^2}\right)_{T_c} = 0 \quad (5.56)$$



to evaluate the coefficients  $a$ ,  $b$ , and  $R$  in terms of the critical pressure, critical temperature, and critical molar volume, respectively,  $P_c$ ,  $T_c$ , and  $V_{mc}$ . The resulting relations are as follows:

$$\begin{aligned} b &= \frac{V_{mc}}{3} & a &= 3P_c V_{mc}^2 & R &= \frac{8P_c V_{mc}}{3T_c} & z_c &= \frac{3}{8} \\ &= \frac{RT_c}{8P_c} & &= \frac{27R^2 T_c^2}{64P_c} & & & & \end{aligned} \quad (5.57)$$

**Berthelot Equation.** This equation is too unwieldy to be used generally as an equation of state. However, it is convenient in calculations of deviations from ideality near pressures of 1 atm; hence, it has been used extensively in the determination of entropies from the third law of thermodynamics. This aspect of the equation will receive more attention in subsequent discussions.

The Berthelot equation can be expressed as

$$\begin{aligned} \left(P + \frac{a}{TV_m^2}\right)(V_m - b) &= RT \\ \text{or } PV_m &= RT \left[1 + \frac{9}{128} \frac{P T_c}{P_c T} \left(1 - 6 \frac{T_c^2}{T^2}\right)\right] \end{aligned} \quad (5.58)$$

**Redlich–Kwong Equation.** The Redlich–Kwong equation, which was proposed in 1949 [5], has been found to reproduce experimental  $P$ – $V$ – $T$  data for gases just as well as several equations that use more than two empirical constants and better than other two-parameter equations [6]. It has the form

$$\left[P + \frac{a}{T^{0.5} V_m (V_m + b)}\right](V_m - b) = RT \quad (5.59)$$

in which  $a$  and  $b$  are the constants characteristic of the gas. They are related to the critical constants of the gas by the equations

$$\begin{aligned} a &= \frac{0.42748 R^2 T_c^{2.5}}{P_c} \\ b &= \frac{0.0866 RT_c}{P_c} \\ Z_c &= \frac{P_c V_{mc}}{RT_c} = \frac{1}{3} \end{aligned} \quad (5.60)$$

where the subscript  $c$  indicates the critical constants and  $Z$  is the compressibility factor [7]. More complex and accurate equations of state are discussed in Ref. [8].

Each of the two-parameter semi-empirical equations above leads to the *law of corresponding states*, first formulated by Van der Waals in 1881 [9], which says that all

gases obey the same equation of state in terms of the reduced variables

$$P_r = P/P_c$$

$$V_{mr} = V_m/V_{mc}$$

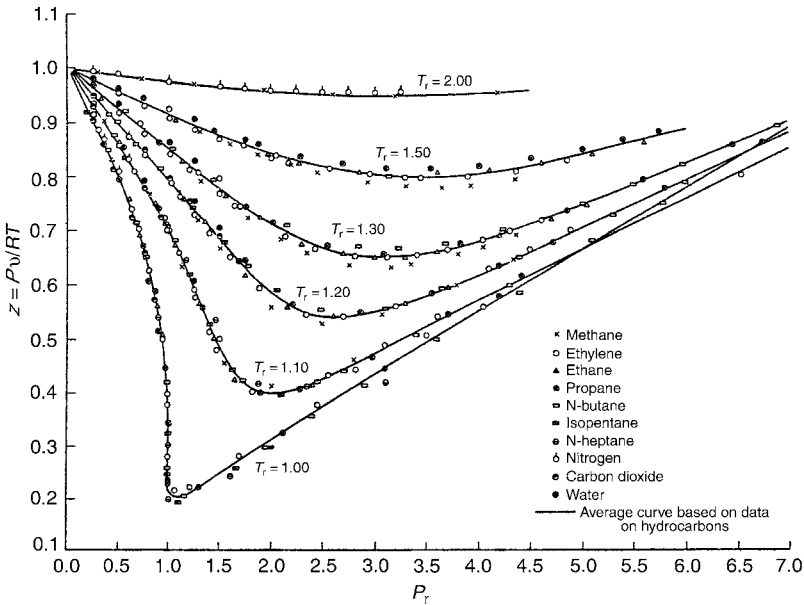
$$T_r = T/T_c$$

Each two-parameter equation for real gases yields a slightly different equation. That such an equation exists for all two-parameter equations was shown by Meslin in 1893 [10].

The behavior of real gases can then be represented with fair precision by a single chart of the compressibility factor  $Z$  as a function of the reduced pressure  $P_r$  in which all gases approximately fit a single curve for a given value of the reduced temperature  $T_r$ . At another reduced temperature, a new curve is obtained for  $Z$  versus  $P_r$ , but it too fits all gases. Therefore, it becomes possible to condense into a single chart of compressibility factors an approximate quantitative graphical representation of the behavior of real gases for a wide range of pressure and temperature [11, 12].

Figure 5.6 is an example of the fit of experimental data to the law of corresponding states.

As the parameters of each of the two-parameter semi-empirical equations can be evaluated in terms of the critical constants of the gases of interest, we provide in Table 5.3 a set of values of the critical constants for some gases of interest.



**Figure 5.6.** Fit of experimental data for ten gases to the law of corresponding states. By permission from G. J. Su, *Ind. Eng. Chem.* **38**, 803 (1946).

**TABLE 5.3. Critical Constants for Some Gases<sup>a</sup>**

Substance	$P_c$ /(MPa)	$T_c$ /K
Acetylene	6.14	308.3
Ammonia	4.39	405.5
Argon	4.86	150.7
Carbon dioxide	7.38	304.4
Carbon monoxide	35.0	133.1
Chlorine	0.814	417.0
Diethyl ether	3.64	466.7
Helium	0.229	5.19
Hydrogen	1.30	33.2
Hydrogen chloride	8.26	324.5
Methane	4.60	190.6
Nitric oxide	6.58	179.8
Nitrogen	3.40	126.2
Nitrogen dioxide	20.17	431
Oxygen	5.08	154.7
Sulfur dioxide	7.89	430.6
Water	22.12	647.3

<sup>a</sup>Used by permission of Flexware, Inc., <http://www.flexwareinc/gasprop.htm>. Critical constants of gases may also be found in Landolt-Börnstein, *Physikalisch-chemische Tabellen*, 6th ed., II. Band, 1. Teil, Springer, Berlin, 1971, pp. 328–377.

**Virial Function.** A useful form of expression for deviations from the ideal gas law is the virial equation,

$$PV_m = A(T) + B(T)P + C(T)P^2 + \dots \quad (5.61)$$

or

$$PV_m = A'(T) + B'(T)\left(\frac{1}{V_m}\right) + C'(T)\left(\frac{1}{V_m^2}\right) + \dots \quad (5.62)$$

in which  $A$ ,  $B$ ,  $C$ ,  $A'$ ,  $B'$ , and  $C'$  are functions of the temperature and are known as *virial coefficients* (Table 5.4). The terms  $A$  and  $A'$  are both equal to  $RT$  because at very low pressures, all gases approach ideal gas behavior. A critical discussion of the virial equation can be found in Ref. 13.

### Joule–Thomson Effect

One method of measuring deviations from ideal behavior quantitatively is by determining the change in temperature in the Joule–Thomson porous-plug experiment (Fig. 5.7). The enclosed gas, initially of volume  $V_1$ , flows very slowly from the left chamber through a porous plug into the right chamber. The pressure on the left side is maintained constant at  $P_1$ , whereas that on the right side also is constant, but at a lower value  $P_2$ . The apparatus is jacketed with an insulator so that no heat is exchanged with the surroundings. Generally, it is observed that the final temperature  $T_2$  differs from the initial temperature  $T_1$ .

TABLE 5.4. Virial Coefficients for Some Gases<sup>a</sup>

Substance	$t/^\circ\text{C}$	$A/(\text{kPa dm}^3 \text{ mol}^{-1})$	$B/(10^{-2} \text{ dm}^3 \text{ mol}^{-1})$	$C/(10^{-10} \text{ dm}^3 (\text{Pa})^{-1} \text{ mol}^{-1})$
Hydrogen <sup>b</sup>	0	2271.1	1.374	0.8806
	100	3102.5	1.567	0.1418
Nitrogen <sup>c</sup>	0	2271.1	-1.027	6.3009
	100	3102.5	0.656	3.3393
Carbon monoxide <sup>d</sup>	0	2271.1	-1.419	6.9570
	100	3102.5	0.449	4.2515

<sup>a</sup>Taken from Ref. 13.

<sup>b</sup>A. Michels, W. de Graaf, T. Wassenaar, J. H. H. Levett, and P. Louwerse, *Phys. Grav.* **25**, 25 (1959); and Ref. 13, p. 205.

<sup>c</sup>A. Michels, H. Wouters, and T. de Boer, *Phys. Grav.* **1**, 587 (1934) and **3**, 585 (1936); and Ref. 13, p. 235.

<sup>d</sup>A. Michels, J. M. Lupton, T. Wassenaar, and W. de Graaf, *Phys. Grav.* **18**, 121 (1952); Ref. 13, p. 45. Reprinted by permission of Oxford University Press.

**Isenthalpic Nature.** As the Joule–Thomson experiment is carried out adiabatically, we can write

$$Q = 0$$

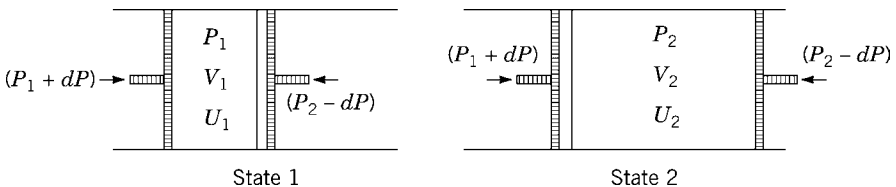
However, it does not follow from this fact alone that  $\Delta H$  also is zero, because the process involves a change in pressure. Nevertheless, it can be shown that the process is an isenthalpic one; that is,  $\Delta H$  is zero.

The work performed by the gas is that accomplished in the right chamber.

$$W_2 = -\int_0^{V_2} P_2 dV = -P_2 V_2 \quad (5.63)$$

plus that performed in the left chamber,

$$W_1 = -\int_{V_1}^0 P_1 dV = P_1 V_1 \quad (5.64)$$



**Figure 5.7.** Schematic representation of a Joule–Thomson porous-plug experiment. The entire experimental apparatus is kept well insulated from the surroundings.

Hence the net work is

$$W = W_1 + W_2 = -P_2V_2 + P_1V_1 \quad (5.65)$$

Similarly, the net gain in energy,  $\Delta U$  is

$$\Delta U = U_2 - U_1 \quad (5.66)$$

As  $Q = 0$ , it follows from the first law of thermodynamics that

$$U_2 - U_1 = W = P_1V_1 - P_2V_2 \quad (5.67)$$

Therefore

$$U_2 + P_2V_2 = U_1 + P_1V_1$$

or

$$H_2 = H_1$$

and

$$\Delta H = 0$$

Thus, we have proved that the Joule–Thomson experiment is isenthalpic as well as adiabatic.

**Joule–Thomson Coefficient.** Knowing that a process is isenthalpic, we can formulate the Joule–Thomson effect quantitatively.

As it is the change in temperature that is observed as the gas flows from a higher to a lower pressure, the data are summarized in terms of a quantity  $\mu_{J.T.}$ , which is defined as

$$\mu_{J.T.} = \left( \frac{\partial T}{\partial P} \right)_H \quad (5.68)$$

The Joule–Thomson coefficient  $\mu_{J.T.}$  is positive when a cooling of the gas (a temperature drop) is observed; because  $dP$  is always negative,  $\mu_{J.T.}$  will be positive when  $dT$  is negative. Conversely,  $\mu_{J.T.}$  is a negative quantity when the gas warms on expansion because  $dT$  then is a positive quantity. Values of the Joule–Thomson coefficient for argon and nitrogen at several pressures and temperatures are listed in Table 5.5.

It frequently is necessary to express the Joule–Thomson coefficient in terms of other partial derivatives. Considering the enthalpy as a function of temperature and pressure  $H(T, P)$ , we can write the total differential

$$dH = \left( \frac{\partial H}{\partial P} \right)_T dP + \left( \frac{\partial H}{\partial T} \right)_P dT \quad (5.69)$$

TABLE 5.5. Joule–Thomson Coefficients<sup>a</sup> for Argon and Nitrogen

$t/^\circ\text{C}$		$\mu_{\text{J.T.}}/(\text{K}(\text{MPa})^{-1})$		
		$P = 101 \text{ kPa}$	$P = 10.1 \text{ MPa}$	$P = 20.2 \text{ MPa}$
300	Ar	0.635	0.439	0.272
	N <sub>2</sub>	0.138	-0.074	-0.169
0	Ar	4.251	2.971	1.858
	N <sub>2</sub>	2.621	1.657	0.879
-150	Ar	17.88	-0.273	-0.632
	N <sub>2</sub>	12.493	0.199	-0.280

<sup>a</sup>The *Smithsonian Physical Tables*, The Smithsonian Institution, Washington, DC, 1954, p. 279. Based on data of Roebuck and Osterberg, *Phys. Rev.* **46**, 785 (1934) and **48**, 450 (1935).

Placing a restriction of constant enthalpy on Equation (5.69), we obtain

$$0 = \left(\frac{\partial H}{\partial P}\right)_T + \left(\frac{\partial H}{\partial T}\right)_P \left(\frac{\partial T}{\partial P}\right)_H$$

which can be rearranged to give

$$\left(\frac{\partial T}{\partial P}\right)_H = -\frac{(\partial H/\partial P)_T}{(\partial H/\partial T)_P} \quad (5.70)$$

or

$$\mu_{\text{J.T.}} = -\frac{1}{C_P} \left(\frac{\partial H}{\partial P}\right)_T \quad (5.71)$$

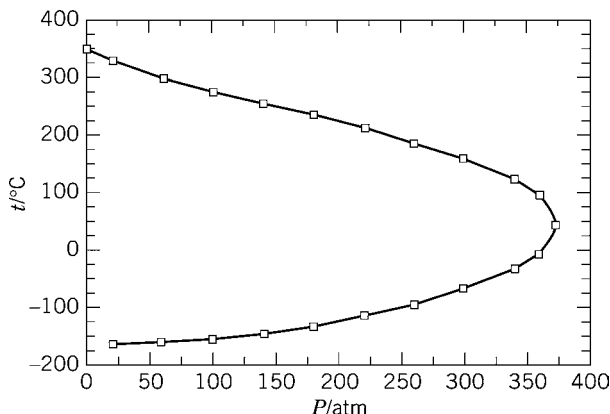
Another relationship of interest can be obtained by substituting the fundamental definition of  $H$  into Equation (5.70):

$$\mu_{\text{J.T.}} = -\frac{1}{C_P} \left(\frac{\partial U}{\partial P}\right)_T - \frac{1}{C_P} \left[\frac{\partial(PV)}{\partial P}\right]_T \quad (5.72)$$

From either of these last two expressions it is evident that  $\mu_{\text{J.T.}} = 0$  for an ideal gas, because each partial derivative is zero for such a substance. It is interesting that  $\mu_{\text{J.T.}}$  does not equal 0 for a real gas at zero pressure except at the inversion temperatures (see below). This result suggests that our assumption that a real gas approaches the properties of an ideal gas at the limit of zero pressure is not entirely correct.

It is also possible to measure  $(\partial H/\partial P)_T$ , the “isothermal” Joule–Thomson coefficient directly, which is a quantity more directly related to deviations from ideality [14].

**Joule–Thomson Inversion Temperature.** The Joule–Thomson coefficient is a function of temperature and pressure. Figure 5.8 shows the locus of points on a temperature–pressure diagram for which  $\mu_{\text{J.T.}}$  is zero. Those points are at the Joule–Thomson inversion temperature  $T_i$ . It is only inside the envelope of this



**Figure 5.8.** Locus of Joule–Thomson inversion temperatures for nitrogen. Data from J. R. Roebuck and H. Osterberg, *Phys. Rev.* **48**, 450 (1935).

curve that  $\mu_{J,T}$  is positive, that is, that the gas cools on expansion. This property is crucial to the problem of liquefaction of gases. Indeed, hydrogen and helium were considered “permanent” gases for many years, until it was discovered that their upper inversion temperatures are below room temperature; thus, they have to be prechilled or else they are heated by expansion.

For conditions under which the van der Waals equation is valid, the Joule–Thomson inversion can be calculated from the expression

$$\frac{2a}{RT_i} - \frac{3abP}{R^2T_i^2} - b = 0 \quad (5.73)$$

(The derivation of Equation (5.73) is dependent on the second law of thermodynamics and will be performed in Section 10.4.) Using Figure 5.8, we can see that Equation (5.73) (a quadratic equation in  $T_i$ ) should have two distinct real roots for  $T_i$  at low pressures, two identical real roots at  $P_{\max}$ , and two imaginary roots above  $P_{\max}$ . At low pressure and high temperature, which are conditions that correspond to the upper inversion temperature, the second term in Equation (5.73) can be neglected and the result is

$$T_i = \frac{2a}{Rb} \quad (5.74)$$

Hence, if the van der Waals constants are known,  $T_i$  can be calculated. For all gases except hydrogen and helium, this inversion temperature is above common room temperatures.

### Calculation of Thermodynamic Quantities in Reversible Expansions

**Isothermal.** The procedure used to calculate the work and energy quantities in an isothermal reversible expansion of a real gas is similar to that used for the ideal gas.

Into the expression for the work performed, Equation (5.19),

$$W = - \int_{V_1}^{V_2} P dV$$

we can substitute for  $P$  (or for  $dV$ ) from the equation of state of the gas and then carry out the required integration. For example, for 1 mole of gas that obeys the van der Waals equation

$$W = - \int_{V_{m1}}^{V_{m2}} \left( \frac{RT}{V_m - b} - \frac{a}{V_m^2} \right) dV_m = -RT \ln \left( \frac{V_{m2} - b}{V_{m1} - b} \right) - \frac{a}{V_{m2}} + \frac{a}{V_{m1}} \quad (5.75)$$

The change in energy in an isothermal expansion cannot be expressed in a simple form without introducing the second law of thermodynamics. Nevertheless, we will anticipate this second basic postulate and use one of the deductions obtainable from it:

$$\left( \frac{\partial U}{\partial V} \right)_T = T \left( \frac{\partial P}{\partial T} \right)_V - P \quad (5.76)$$

For a gas that obeys the van der Waals equation, Equation (5.76) reduces to

$$\left( \frac{\partial U}{\partial V} \right)_T = \frac{a}{V_m^2} = \left( \frac{\partial U_m}{\partial V_m} \right)_T \quad (5.77)$$

$\Delta U_m$  can be obtained by integrating this equation:

$$\Delta U_m = \int_{V_{m1}}^{V_{m2}} \frac{a}{V_m^2} dV_m = -\frac{a}{V_{m2}} + \frac{a}{V_{m1}} \quad (5.78)$$

From the first law of thermodynamics, we now can calculate the heat absorbed in the isothermal reversible expansion:

$$Q = \Delta U_m - W = RT \ln \frac{V_{m2} - b}{V_{m1} - b} \quad (5.79)$$

$\Delta H_m$  can be obtained from Equation (4.5):

$$\Delta H_m = \Delta U_m + \Delta(PV_m)$$



The  $PV_m$  product can be calculated from the van der Waals equation in the form

$$P = \frac{RT}{V_m - b} - \frac{a}{V_m^2} \quad (5.80)$$

by multiplying each term by  $V_m$ :

$$PV_m = RT \frac{V_m}{V_m - b} - \frac{a}{V_m} \quad (5.81)$$

With a few algebraic manipulations, we can show that

$$(PV_m)_2 - (PV_m)_1 = \Delta(PV_m) = bRT \left[ \frac{1}{V_{m2} - b} - \frac{1}{V_{m1} - b} \right] - \frac{a}{V_{m2}} + \frac{a}{V_{m1}} \quad (5.82)$$

Adding Equations (5.78) and (5.82), we obtain

$$\Delta H_m = bRT \left[ \frac{1}{V_{m2} - b} - \frac{1}{V_{m1} - b} \right] - \frac{2a}{V_{m2}} + \frac{2a}{V_{m1}} \quad (5.83)$$

**Adiabatic.** In an adiabatic change of state,  $Q$  equals zero. However, a calculation of the work and energy quantities depends on the integration of Equation (4.59) for the change in energy. Furthermore, specifying the equation of state for the gas does not give automatically an expression for the dependence of  $C_V$  on temperature. When adequate equations, empirical or theoretical, for the variation of  $U$  and  $C_V$  with  $T$  and  $V$  are available, they can be used in Equation (4.59). If the resulting expression is integrable analytically, the energy and work quantities can be calculated as for an ideal gas. If the expression is not integrable analytically, numerical or graphical procedures can be used (see Section A.2).

## EXERCISES

When derivations or proofs of equations are called for, start from fundamental definitions and principles.

- 5.1. Derive an explicit equation for the reversible work of an isothermal expansion for each of the following cases:
  - a. When  $P$  is given by the equation of state of an ideal gas.
  - b. When  $P$  is obtained from the van der Waals equation of state.
  - c. When  $dV_m$  is obtained from the equation of state,  $PV_m = RT + BP + CP^2$ .
  - d. When  $dV_m$  is obtained from the Berthelot equation.
  - e. When  $P$  is obtained from the Redlich–Kwong equation.

- 5.2.** Derive an explicit expression for the work performed in the irreversible expansion of a gas from volume  $V_1$  to volume  $V_2$  against a constant external pressure  $P'$  that is less than the pressure of the gas throughout the expansion.
- 5.3.** Rozen [15] characterizes gases by “deviation coefficients” such as  $T(\partial P/\partial T)_V/P$ ,  $P(\partial V_m/\partial T)_P/R$ , and  $P^2(\partial V_m/\partial P)_T/(RT)$ . Calculate the values of these coefficients for (a) an ideal gas, (b) a gas that obeys the van der Waals equation, and (c) a gas that obeys the Dieterici equation of state,

$$P = \frac{RT}{V_m - b} e^{-a/RTV_m}$$

- 5.4.** Derive expressions for  $W$ ,  $\Delta U$ ,  $Q$ , and  $\Delta H$  in an isothermal reversible expansion of 1 mole of a gas that obeys the equation of state  $PV_m = RT + BP$ . Use Equation (5.76) to calculate  $\Delta U$ .
- 5.5.** A gas obeys the equation of state  $PV_m = RT + BP$  and has a molar heat capacity  $C_{V_m}$  that is independent of the temperature.
- Derive an expression relating  $T$  and  $V$  in an adiabatic reversible expansion.
  - Derive an equation for  $\Delta H_m$  in an adiabatic reversible expansion.
  - Derive an equation for  $\Delta H_m$  in an adiabatic free expansion.
- 5.6. a.** Given the equation

$$C_P = C_V + \left[ V \left( \frac{\partial H}{\partial P} \right)_T \right] \left( \frac{\partial P}{\partial T} \right)_V$$

derive the relationship

$$C_V = C_P \left[ 1 - \mu_{J.T.} \left( \frac{\partial P}{\partial T} \right)_V \right] - V \left( \frac{\partial P}{\partial T} \right)_V$$

- To what expression can this equation be reduced at the inversion temperature?
- 5.7.** For a monatomic ideal gas,  $C_{v,m} = 3/2 R$ . Calculate the work performed in an adiabatic reversible expansion of 1 mole of this gas by integrating Equation (5.41).
- 5.8.** An ideal gas absorbs 9410 J of heat when it is expanded isothermally (at 25°C) and reversibly from 1.5 dm<sup>3</sup> to 10 dm<sup>3</sup>. How many moles of the gas are present?
- 5.9.** Derive the following relationship for an ideal gas:

$$\left( \frac{\partial U}{\partial V} \right)_P = \frac{C_{V,m}P}{R}$$

5.10. Keeping in mind that  $dU$  is an exact differential, prove that for an ideal gas

$$\left(\frac{\partial C_V}{\partial V}\right)_T = 0$$

$$\left(\frac{\partial C_P}{\partial P}\right)_T = 0$$

5.11. With the aid of a McLaurin series, a polynomial in  $1/V_m$ , expanded about  $V_m = 0$ , it is possible to relate the constants of the virial equation to the van der Waals constants  $a$  and  $b$ .

a. Rearrange the van der Waals equation to the form

$$\begin{aligned} PV_m &= \frac{RTV_m}{V_m - b} - \frac{a}{V_m} \\ &= \frac{RT}{1 - b\left(\frac{1}{V_m}\right)} - a\left(\frac{1}{V_m}\right) \end{aligned}$$

and expand  $PV_m$  as a polynomial in  $(1/V_m)$  to obtain the coefficients in the equation

$$PV_m = RT + B\left(\frac{1}{V_m}\right) + C\left(\frac{1}{V_m}\right)^2$$

b. Show that

$$B = b \frac{a}{RT}$$

$$C = b^2$$

c. The Boyle temperature is defined as that at which

$$\lim_{P \rightarrow 0} \left[ \frac{\partial(PV_m)}{\partial(1/V_m)} \right]_T = 0$$

Use the virial form of the van der Waals equation to show that

$$T_{\text{Boyle}} = \frac{a}{Rb}$$

5.12. Using  $T$  and  $V$  as coordinates, sketch a graph that shows the three adiabatic expansions of Table 5.2.

5.13. According to the theory of acoustics, the velocity of propagation of sound  $w$  through a gas is given by the equation

$$w^2 = \frac{\partial P}{\partial \rho}$$

in which  $\rho$  is the density of the gas.

- a. If the propagation of sound is assumed to occur adiabatically, and if the transmitting gas acts as if it were ideal and as if it were undergoing reversible compressions and expansions, show that

$$w^2 = \frac{C_P RT}{C_V M}$$

(Hint: Take 1 mole of gas and find a relationship between  $dp$  and  $dV$ .)

- b. Calculate  $w$  for sound in air assuming  $C_P/C_V$  is  $7/5$ .  
 c. If the propagation of sound is assumed to occur isothermally, show that

$$w^2 = \frac{RT}{M}$$

- 5.14. Derive an equation for the coefficient of thermal expansion  $\alpha$ :

$$\alpha = \frac{1}{V} \left( \frac{\partial V}{\partial T} \right)_P$$

for a gas that obeys the van der Waals equation.

(Hint: Equation (5.54) could be solved explicitly for  $V_m$  and then differentiated. However, an equation explicit in  $V_m$  would be cubic and unwieldy; it is much easier to differentiate Equation (5.79) implicitly with respect to  $T$ .)

- 5.15. For a rubber band, the internal energy  $U$  equals  $f(T, L)$ ;  $L$  is the length of the band. For a particular type of rubber

$$\left( \frac{\partial U}{\partial L} \right)_T = -\frac{1}{L^2}$$

and

$$\left( \frac{\partial U}{\partial T} \right)_L = C_L = \text{constant}$$

A stretched rubber band of length  $L_2$  is allowed to snap back to length  $L_1$  under adiabatic conditions and without doing any work. Will its temperature change? Show clearly the reason for your conclusion. Show that you need to find the derivative  $(\partial T/\partial L)_U$ .

- 5.16. Express the compressibility factor  $Z = (PV_m)/(RT)$  for a gas that follows the Redlich–Kwong equation. Convert the resulting equation into one in which the independent variable is  $(1/V_m)$ . Obtain a McLaurin series for  $Z$  as a polynomial in  $(1/V_m)$ , and express the virial coefficients for that equation in terms of the parameters of the Redlich–Kwong equation.

TABLE 5.6. PVT Data for  $\text{CF}_3\text{OCH}_3$ 

$T/\text{K}$	$P/\text{kPa}$	$\rho/\text{kg m}^{-3}$
380	3786.4	439.7
380	3686.3	294.2
380	3316.9	198.3
380	2726.4	131.8
380	2092.4	87.73
380	1529.5	58.32
380	1084	38.82
380	752.6	25.86
380	515.4	17.23
380	350.5	11.51
380	236.5	7.671
380	158.9	5.114

- 5.17. Use the critical constants for hydrogen given in Table 5.3 to calculate the parameters  $a$  and  $b$  for the van der Waals and Redlich–Kwong equations for hydrogen. Use each of these equations to calculate the compressibility factor  $z$  for hydrogen as a function of  $1/V_m$  at 50 K between 0.1 MPa and 20 MPa, and compare your calculated values with the experimental values of Johnston and White [16].

(Hint: Transform the van der Waals and Redlich–Kwong equations into equations that express the compressibility factor  $z$  as polynomials in  $1/V_m$  using McLaurin's theorem and thereby relate the constants  $a$  and  $b$  to the virial coefficients.)

- 5.18. Kayukawa et al. [17] studied the PVT properties of trifluoromethyl methyl ether, because it is a possible refrigerant with zero ozone depletion potential and low global-warming potential. One series of their data is shown in Table 5.6. Calculate  $Z$ , the compressibility factor, and the molar volume in  $\text{mol m}^{-3}$  from the given data, and fit the data for  $Z$  as a function of  $1/V_m$  to both a linear and a quadratic equation to see whether a third virial coefficient is warranted by the data.

## REFERENCES

1. G. L. Bertrand, *J. Chem. Educ.* **82**, 874 (2005).
2. D. Shanks, *Am. J. Phys.* **24**, 352 (1956).
3. T. Andrews, *Phil. Trans. Roy. Soc. (London)* **159**, 575 (1869); More recent measurements of the isothermals for  $\text{CO}_2$  can be found in A. Michels, B. Blaisse, and C. Michels, *Proc. Roy. Soc. (London)* **160A**, 358 (1937).
4. J. D. van der Waals: *On the Continuity of the Gaseous and Liquid States*, J. S. Rowlinson, ed., North Holland, Amsterdam, The Netherlands, 1988. This work is an English translation, with commentary of the Ph.D. dissertation of van der Waals.

5. O. Redlich and J. N. S. Kwong, *Chem. Rev.* **44**, 233 (1949).
6. A. L. Horvath, *Chem. Eng. Sci.* **29**, 1334 (1974); K. K. Shah and G. Thodos, *Ind. and Eng. Chem.* **57**, 30 (1965); A. Bjerre and T. A. Bak, *Acta Chem. Scand.* **23**, 1733 (1969); J. B. Ott, J. R. Coates, and H. T. Hall, Jr., *J. Chem. Educ.* **48**, 515 (1971); M. K. Kemp, R. E. Thompson, and D. J. J. Zigrang, *J. Chem. Educ.* **52**, 802 (1975).
7. R. W. Hakala, *J. Chem. Educ.* **62**, 110 (1985); M. E. Cardinali and C. Giomini, *J. Chem. Educ.* **66**, 402 (1989); C. Castillo, *J. Chem. Educ.* **68**, 47 (1991).
8. B. E. Poling, J. M. Prausnitz, and J. P. O'Connell, *The Properties of Gases and Liquids*, McGraw-Hill New York, 2001, p. 4.24.
9. J. D. Van der Waals, *Koninklijke Akademie van Wetenschappente Amsterdam, Proceedings of the Section of the Sciences*, **15**, 971–981 (1913).
10. M. G. Meslin, *Compte Rendus Hebdomadaires des Seances de l'Academic des Sciences*, **116**, 135–136 (1893).
11. O. A. Hougen, K. M. Watson, and R. A. Ragatz, *Chemical Process Principles, Part II*, Wiley, New York, 1959, Chap. XII; L. C. Nelson and E. F. Obert, *Chem. Eng. Trans. ASME* **76**, 1057 (1954), pp. 203–208.
12. The compressibility can be represented to a high precision if it is expressed as a function of another parameter in addition to the reduced temperature and reduced pressure. See K. S. Pitzer, D. Z. Lippman, R. F. Curl, Jr., C. M. Huggins, and D. E. Peterson, *J. Am. Chem. Soc.* **77**, 3433 (1955), and O. Redlich and V. B. T. Ngo, *Ind. Eng. Chem. Fundls.* **9**, 287 (1970).
13. E. A. Mason and T. H. Spurling, *The Virial Equation of State*, Pergamon Press Oxford, UK, 1969; J. D. Cox and I. J. Lawrenson, 'The  $P$ ,  $V$ ,  $T$  Behavior of Single Gases', in *Chemical Thermodynamics, A Specialist Periodical Report*, Vol. 1, M. L. McGlashan, ed., The Chemical Society, London, 1973, pp. 162–203; J. H. Dymond and E. B. Smith, *The Virial Coefficients of Pure Gases and Mixtures, A Critical Compilation*, The Clarendon Press, Oxford, UK, 1980; J. H. Dymond, K. N. Marsh, R. Wilhoit, and S. Wong, *Virial Coefficients of Gases—Vol. 21A. Pure Compounds*, Landolt-Börnstein New Series, Physical Chemistry, Springer, Berlin, 2004; J. H. Dymond, K. N. Marsh, R. Wilhoit, and S. Wong, *Virial Coefficients of Gases—Vol. 21B. Gas Mixtures*, Landolt-Börnstein New Series, Physical Chemistry, Springer, Berlin, 2004.
14. P. G. Francis, M. L. McGlashan, and C. J. Wormald, *J. Chem. Thermodynamics* **1**, 441 (1969).
15. A. M. Rozen, *J. Phys. Chem. (USSR)* **19**, 469 (1945); A. M. Rozen, *Chem. Abstr.* **40**, 1712 (1946).
16. H. L. Johnston and D. White *Trans. Am. Soc. Mech. Eng.* **22**, 785 (1950).
17. Y. Kayukawa, M. Hasumoto, T. Hondo, and K. Watanabe *J. Chem. Eng. Data* **48**, 1141 (2003).



## CHAPTER 6

---

# THE SECOND LAW OF THERMODYNAMICS

---

### 6.1 THE NEED FOR A SECOND LAW

For a scientist, the primary interest in thermodynamics is in predicting the *spontaneous* direction of natural processes, chemical or physical, in which by “spontaneous” we mean those changes that occur irreversibly in the absence of restraining forces—for example, the free expansion of a gas or the vaporization of a liquid above its boiling point. The first law of thermodynamics, which is useful in keeping account of heat and energy balances, makes no distinction between reversible and irreversible processes and makes no statement about the natural direction of a chemical or physical transformation.

As we noticed in Table 5.1,  $\Delta U = 0$  both for the free expansion and for the reversible expansion of an ideal gas. We used an ideal gas as a convenient example because we could calculate easily the heat and work exchanged. Actually, for any gas,  $\Delta U$  has the same value for a free and a reversible expansion between the corresponding initial and final states. Furthermore,  $\Delta U$  for a compression is equal in magnitude and opposite in sign to  $\Delta U$  for an expansion; no indication occurs from the first law of which process is the spontaneous one.

A clue to the direction that needs to be followed to reach a criterion of spontaneity can be obtained by noticing in Table 5.1 that  $Q$  and  $W$  are equal to zero for the *reversible cycle* but are *not zero* for the *irreversible cycle*. In other words, it is changes in the *surroundings* as well as changes in the system that must be considered in distinguishing a reversible from an irreversible transformation. Evidently, then, we need to find a



concept or quantity that incorporates some treatment of the surroundings to serve as a criterion of spontaneity. Ideally, we should find a state function, instead of path-dependent quantities such as heat or work. Such a function would provide the foundation for the formulation of the general principle (or law) that we are seeking.

## 6.2 THE NATURE OF THE SECOND LAW

### Natural Tendencies Toward Equilibrium

The natural tendency of systems to proceed toward a state of equilibrium is exhibited in many familiar forms. When a hot object is placed in contact with a cold object, they reach a common temperature. We describe the change by saying that heat has flowed from the hot object to the cold object. However, we never observe that two objects in contact and at the same temperature spontaneously attain a state in which one has a high temperature and the other a low temperature. Similarly, if a vessel containing a gas is connected to an evacuated vessel, the gas will effuse into the evacuated space until the pressures in the two vessels are equal. Once this equilibrium has been reached, it never is observed that a pressure difference between the two vessels is produced spontaneously. Solutes diffuse from a more concentrated solution to a more dilute solution; concentration gradients never develop spontaneously. Magnets spontaneously become demagnetized; their magnetism never increases spontaneously. When a concentrated protein solution such as egg white is placed in a vessel of boiling water, the egg white coagulates, but we never observe that coagulated egg white at the temperature of boiling water returns spontaneously to a liquid state.

It is desirable to find some common measure (preferably a quantitative measure) of the tendency to change and of the direction in which change can occur. In the 1850s, Clausius and Kelvin independently formulated the second law of thermodynamics, and Clausius invented the term “entropy  $S$ ” (from the Greek word  $\tau\rho\omicron\pi\eta$ , which means transformation), to provide a measure of the “transformational content” or the capacity for change. In this chapter, we will develop the properties of this function and its relationship to the direction and extent of natural processes as expressed in the second law of thermodynamics.

### Statement of the Second Law

Numerous equivalent statements of the second law exist. We will begin with the following statement proposed by Clausius:

It is impossible to construct a machine that is able to convey heat by a cyclical process from one reservoir (at a low temperature) to another at a higher temperature unless work is done on the machine by some outside agency.

The second law, like the first law, is a postulate that has not been derived from any prior principles. It is accepted because deductions from the postulate correspond to

experience. Except in submicroscopic phenomena, to which classical thermodynamics does not apply, no exceptions to the second law have been found.

The statement that we have chosen to use as the fundamental expression of the second law of thermodynamics is in a form that resembles some other fundamental principles of physical science. It is expressed as a “principle of impotence” [1], that is, an assertion of the impossibility of carrying out a particular process. In physics, such principles of impotence occur frequently. For example, the impossibility of sending a signal with a speed greater than that of light in a vacuum provides the basis for the theory of relativity. Also, wave mechanics may be considered to be a consequence of the impossibility of measuring simultaneously the position and velocity of an elementary particle. Similarly, we can state the first law of thermodynamics in terms of humanity’s impotence to construct a machine capable of producing energy from nothing, a so-called “perpetual-motion machine of the first kind.” The second law describes an additional incapacity, “the impossibility of constructing a perpetual-motion machine of the second kind.” Such a machine would operate without contradicting the first law, but still it would provide an inexhaustible supply of work.

### Mathematical Counterpart of the Verbal Statement

In the form in which it has been expressed thus far, the second law is not a statement that can be applied conveniently to chemical problems. We wish to use the second law of thermodynamics to establish a criterion by which we can determine whether a chemical reaction or a phase change will proceed spontaneously. Such a criterion would be available if we could obtain a function that had the following two characteristics.

1. It should be a thermodynamic property; that is, its value should depend only on the state of the system and not on the particular path by which the state has been reached.
2. It should change in a characteristic manner (for example, always increase) when a reaction proceeds spontaneously.

The entropy function of Clausius satisfies these requirements. Although the subject of heat engines at first may seem unpromising in searching for a general principle to predict which processes are spontaneous, such engines can also be viewed as general devices for the interconversion of heat and work. Their properties will provide a useful basis for developing the mathematical properties of the entropy function and a mathematical statement of the second law. Therefore, we shall consider the properties of the ideal heat engine described by Carnot.

## 6.3 THE CARNOT CYCLE

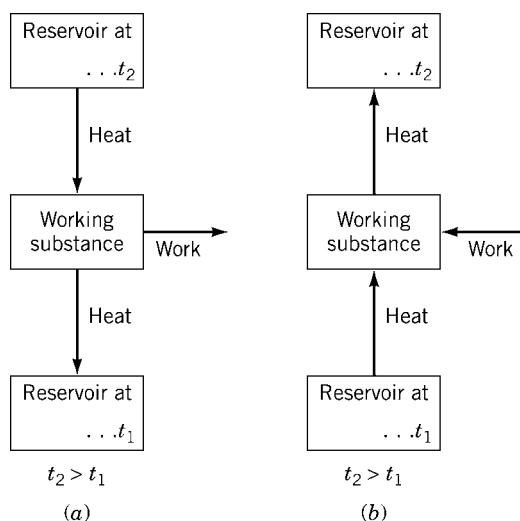
The Carnot engine is a device by which a working substance can exchange mechanical work with its surroundings and can exchange heat with two heat reservoirs,

one at a high temperature  $t_2$  and one at a low temperature  $t_1$ , as shown schematically in Figure 6.1. (As we wish to derive the properties of the entropy function without reference to the properties of the ideal gas, we shall use any convenient empirical scale, rather than the ideal gas temperature scale, as a preliminary measure of temperature.)

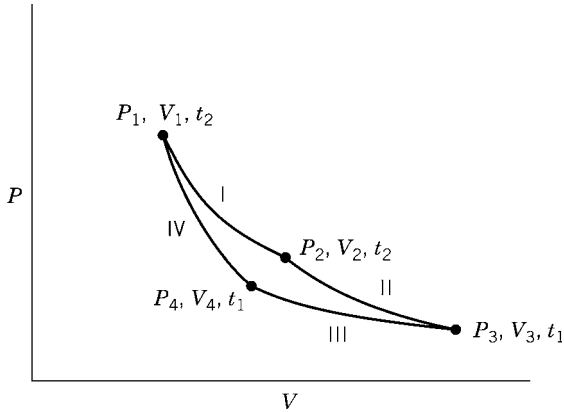
### The Forward Cycle

The Carnot cycle is a series of four steps that the working substance undergoes in the operation of the engine. At the completion of the four steps, the working substance has been returned to its initial state. In the forward direction, in which the engine transfers a net amount of heat to the working substance and does a net amount of work on the surroundings, the four steps are as follows:

- Step I. A reversible isothermal expansion in thermal contact with the high-temperature reservoir at  $t_2$ .
- Step II. A reversible adiabatic expansion in which the temperature of the working substance decreases to  $t_1$ .
- Step III. A reversible isothermal compression in thermal contact with the low-temperature reservoir at  $t_1$ .
- Step IV. A reversible adiabatic compression in which the temperature of the working substance increases to  $t_2$  and the substance is returned to its initial state.



**Figure 6.1.** Scheme of a Carnot engine as (a) a heat engine and (b) as a refrigerator or heat pump.

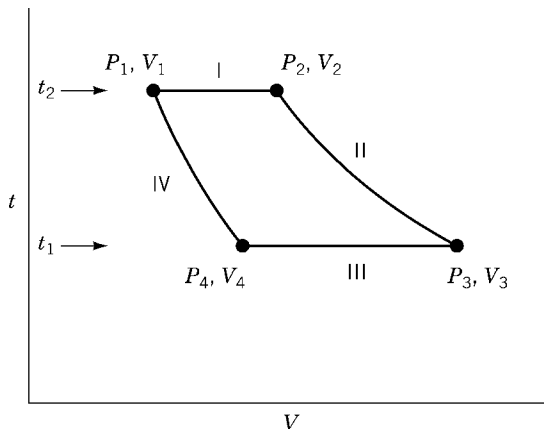


**Figure 6.2.** Carnot cycle: pressure–volume diagram.

Such a cycle is represented as a pressure–volume diagram in Figure 6.2. The representation of a temperature–volume diagram in Figure 6.3 emphasizes the isothermal nature of Steps I and III.

Let  $Q_2$  (a positive quantity) represent the heat exchanged with the high-temperature reservoir in Step I, let  $Q_1$  (a negative quantity) represent the heat exchanged with the low-temperature reservoir in Step III, and let  $W$  be the net work performed (by the system).  $W$  is represented in Figure 6.2 by the negative of the area within the cycle; that is,

$$W = -\oint PdV \quad (6.1)$$



**Figure 6.3.** Carnot cycle: temperature–volume diagram.

As the working substance returns to its initial state at the end of the cycle

$$\Delta U = 0 \quad (6.2)$$

Then from the first law

$$-W = Q_1 + Q_2 \quad (6.3)$$

The proportion  $\varepsilon$  of the heat absorbed at the high temperature that is converted to work represents a useful characteristic of a heat engine:

$$\varepsilon = -\frac{W}{Q_2} \quad (6.4)$$

and the negative sign ensures that  $\varepsilon$  is positive, because  $W$  and  $Q_2$  are always opposite in sign. Substituting for  $W$  from Equation (6.3) into, Equation (6.4), we obtain

$$\varepsilon = \frac{Q_1 + Q_2}{Q_2} \quad (6.5)$$

$$= 1 + \frac{Q_1}{Q_2} \quad (6.6)$$

The quantity  $\varepsilon$  usually is called the *efficiency* of the engine.

### The Reverse Cycle

As the Carnot engine is a reversible device, it can be operated in the opposite direction, with each step traversing the same path and characterized by the same heat and work quantities but opposite in sign [see Fig. 6.1(b)]. The reverse engine absorbs heat from the low-temperature reservoir, has work performed on it by the surroundings, and liberates heat to the high-temperature reservoir. Thus, it acts as a *heat pump* or as a *refrigerator*. Its operation does not contradict the Clausius statement of the second law, because the surroundings do work to transport heat from the low-temperature reservoir to the high-temperature reservoir.

If we designate the heat and work quantities for the reverse cycle by primed symbols, the reverse and forward relationships are

$$\begin{aligned} W' &= -W \\ Q_2' &= -Q_2 \\ Q_1' &= -Q_1 \end{aligned} \quad (6.7)$$

and

$$\varepsilon = \frac{-W}{Q_2} = \frac{-W'}{Q_2'} \quad (6.8)$$

$$= \frac{Q_1' + Q_2'}{Q_2'} = 1 + \frac{Q_1'}{Q_2'} \quad (6.9)$$

Thus,  $\varepsilon$  is the same for both the forward and the reverse cycles.<sup>1</sup>

### Alternative Statement of the Second Law

In addition to the statement we have been using, several alternative ways exist to express the second law. One that will be particularly useful is the Kelvin–Planck statement:

It is impossible to construct a machine that, operating in a cycle, will take heat from a reservoir at constant temperature and convert it into work without accompanying changes in the reservoir or its surroundings.

If such a machine could be constructed, it would be a “perpetual-motion machine of the second kind.”

To prove this statement, we shall rely on the technique of assuming that it is false—that heat can be converted into work in a cyclic isothermal process without other changes occurring in the reservoir or the surroundings. Suppose that we carry out a cyclic process in which heat from the reservoir at a constant temperature  $t_2$  is converted completely into work. Then  $\Delta U = 0$  because the system is returned to its initial state. The work obtained can be used to operate a reversible Carnot engine as a refrigerator. This cycle transfers a quantity of heat from a reservoir at the lower temperature  $t_1$  to the reservoir at the higher temperature  $t_2$  of the original isothermal cycle. The amount of heat first removed from the high-temperature reservoir is equivalent to the work obtained from the isothermal cycle. The heat  $Q$  now added to the high-temperature reservoir is the sum of the heat ( $-Q_1$ ) removed from the low-temperature reservoir and the heat equivalent of the work performed by the isothermal cycle. The net work performed in the combined cycles is zero. The final result of the combined cycles is the transfer of heat from the lower temperature reservoir at  $t_1$  to the higher temperature reservoir at  $t_2$  in a cyclic process with no other changes in the system or surroundings. This result contradicts the Clausius statement of the second law. Therefore, the assumption that heat can be converted into work in a

<sup>1</sup>It is sometimes convenient to define a coefficient of performance for a refrigerator as  $\beta = Q_1'/W'$ , which is equal to  $(1/\varepsilon) - 1$ . Similarly, a coefficient of performance for a heat pump can be defined as  $\gamma = -Q_2'/W'$ , which is equal to  $1/\varepsilon$ . Thus, a reversible frictionless heat pump transfers as heat to the high temperature reservoir a multiple of the work done on the engine, and, in some circumstances, a real heat pump can be more economical than direct combustion as a source of heat.

**TABLE 6.1. Coupling of Two Carnot Cycles with Different Efficiencies**

	Engine B (Forward Cycle)	Engine A (Reverse Cycle)	Net Change for Working Substances	Net Change for Reservoirs
$Q_2$	100 J	-120 J	-20 J	20 J
$W$	-60 J	60 J	0	
$Q_1$	-40 J	60 J	20 J	-20 J

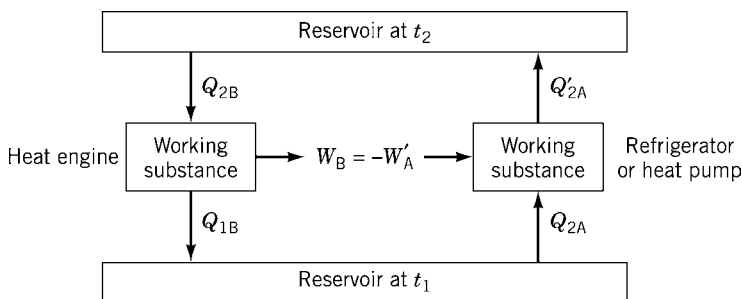
cyclic isothermal process is false. Thus, the Kelvin–Planck statement is as valid a form of the second law as is the Clausius statement.

### Carnot's Theorem

Carnot stated that the efficiency of a reversible Carnot engine depends only on the temperatures of the heat reservoirs and is independent of the nature of the working substance. This theorem can be proved by showing that the assumption of a reversible engine with any but the known efficiency of a reversible Carnot engine leads to a contradiction of the Clausius statement of the second law.

Let us illustrate the principle of this proof with a specific numeric example. If the ideal Carnot engine A has an efficiency  $\varepsilon_A = 0.5$ , which is dependent only on the temperatures of the reservoirs, let us assume that engine B has a higher efficiency,  $\varepsilon_B = 0.6$ . If 100 joules of heat are absorbed from the high-temperature reservoir by engine B operating in the forward cycle, then the engine will do 60 J of work on the surroundings and 40 J of heat will be transferred to the low-temperature reservoir, as listed in the first column of Table 6.1.

If the work performed by engine B is used to operate engine A in reverse, as illustrated in Figure 6.4, then  $W$  for engine A is 60 J,  $Q_2$  is equal to -120 J, and  $Q_1$  is equal to 60 J, as listed in the second column in Table 6.1. Thus, the net result of the coupling of the two cycles is that 20 J of heat has been removed from the low-temperature reservoir and has been added to the high-temperature reservoir, with no work performed and no other changes occurring, because both working



**Figure 6.4.** Scheme of two Carnot engines, one acting as a heat engine and the other as a refrigerator or heat pump.

substances have been returned to their initial states. This result contradicts the Clausius statement of the second law. Consequently, engine B cannot have a higher efficiency than that of the ideal Carnot engine A.

Now we can demonstrate the proof in a general way, with the scheme shown in Figure 6.4. If the efficiency of a Carnot engine A is  $\varepsilon_A$ , we can assume a second engine B, with efficiency  $\varepsilon_B > \varepsilon_A$ . When B is operated in the forward direction, thus exchanging heat  $Q_{2B}$  (a positive quantity) with the high-temperature reservoir, performing work  $W_B$  (a negative quantity) on the surroundings, and exchanging heat  $Q_{1B}$  (a negative quantity) with the low-temperature reservoir, we obtain

$$\varepsilon_B = \frac{-W_B}{Q_{2B}} \quad (6.10)$$

The Carnot engine A operated in a reverse cycle between the same heat reservoirs exchanges heat  $Q'_{1A}$  with the low-temperature reservoir and is made to use all the work available from engine B so that work  $W'_A = -W_B$ ; it also exchanges heat  $Q'_{2A}$  with the high-temperature reservoir. The two engines are coupled through the exchange of work.

As  $\varepsilon_B$  is assumed greater than  $\varepsilon_A$

$$\frac{-W_B}{Q_{2B}} > \frac{-W'_A}{Q'_{2A}} \quad (6.11)$$

Because we will compare the magnitudes of the quantities rather than their value, we shall use their absolute values. As  $W_B$  and  $Q_{2B}$  have opposite signs, as do  $W'_A$  and  $Q'_{2A}$ , the ratios in Equation (6.11) are equal to the ratios of the absolute values. Thus,

$$\frac{|W_B|}{|Q_{2B}|} > \frac{|W'_A|}{|Q'_{2A}|} \quad (6.12)$$

As  $W_B = -W'_A$

$$|W_B| = |W'_A| \quad (6.13)$$

Therefore

$$\frac{1}{|Q_{2B}|} > \frac{1}{|Q'_{2A}|}$$

or

$$|Q_{2B}| < |Q'_{2A}| \quad (6.14)$$

Thus, the amount of heat returned to the high-temperature reservoir in the reverse cycle is greater than the amount removed from it in the forward cycle.

By a similar argument, it can be shown that the amount of heat added to the low-temperature reservoir in the forward cycle is less than the amount removed from it in



the reverse cycle. The working substances of both engines have returned to their initial states, so  $\Delta U = 0$  for the entire process. The net work performed is zero because the work produced by the forward engine was used entirely to operate the reverse engine. Thus, heat was transported to the high-temperature reservoir from the low-temperature reservoir in a cyclic process without any work being performed, which contradicts the Clausius statement of the second law.

By a similar argument, it can be shown that the assumption of an efficiency less than  $\epsilon_A$  also leads to a contradiction of the second law. Thus, any reversible Carnot engine operating between the same pair of reservoirs has the same efficiency, and that efficiency must be a function only of the *temperatures* of the *reservoirs*.

$$\epsilon = f(t_1, t_2) = -\frac{Q_2}{Q_1} \quad (6.15)$$

#### 6.4 THE THERMODYNAMIC TEMPERATURE SCALE

Equation (6.16), which includes Equation (6.6), is a mathematical statement of Carnot's theorem:

$$\epsilon = 1 + \frac{Q_1}{Q_2} = f(t_1, t_2) \quad (6.16)$$

Solving for  $Q_1/Q_2$ , we obtain

$$\frac{Q_1}{Q_2} = -[1 - f(t_1, t_2)] \quad (6.17)$$

$$= -g(t_1, t_2) \quad (6.18)$$

As  $Q_1$  and  $Q_2$  have opposite signs, their ratio is opposite in sign to the ratio of their absolute values. Thus,

$$\frac{|Q_1|}{|Q_2|} = g(t_1, t_2) \quad (6.19)$$

Now consider a group of three heat reservoirs at temperatures  $t_1 < t_2 < t_3$  and a reversible Carnot engine that operates successively between any pair of reservoirs. According to Equation (6.19)

$$\frac{|Q_1|}{|Q_2|} = g(t_1, t_2) \quad (6.20)$$

$$\frac{|Q_1|}{|Q_3|} = g(t_1, t_3) \quad (6.21)$$

and

$$\frac{|Q_2|}{|Q_3|} = g(t_2, t_3) \quad (6.22)$$

If Equation (6.21) is divided by Equation (6.22), the result is

$$\frac{|Q_1|}{|Q_2|} = \frac{g(t_1, t_3)}{g(t_2, t_3)} \quad (6.23)$$

Equating the right sides of Equation (6.20) and Equation (6.23), we obtain

$$g(t_1, t_2) = \frac{g(t_1, t_3)}{g(t_2, t_3)} \quad (6.24)$$

As the quantity on the left side of Equation (6.23) depends only on  $t_1$  and  $t_2$ , the quantity on the right side also must be a function only of  $t_1$  and  $t_2$ . Therefore,  $t_3$  must appear in the numerator and denominator of the right side in such a way as to cancel, which thereby gives

$$g(t_1, t_2) = \frac{h(t_1)}{h(t_2)} \quad (6.25)$$

Substituting from Equation (6.25) into Equation (6.19), we have

$$\frac{|Q_1|}{|Q_2|} = \frac{h(t_1)}{h(t_2)} \quad (6.26)$$

As the magnitude of the heat exchanged in an isothermal step of a Carnot cycle is proportional to a function of an empirical temperature scale, the magnitude of the heat exchanged can be used as a thermometric property. An important advantage of this approach is that the measurement is independent of the properties of any particular material, because the efficiency of a Carnot cycle is independent of the working substance in the engine. Thus we define a thermodynamic temperature scale (symbol  $T$ ) such that

$$\frac{|Q_2|}{|Q_1|} = \frac{T_2}{T_1} \quad (6.27)$$

with the units of the scale defined by setting  $T = 273.16$  K (kelvin) at the triple point of water.

Removing the absolute value signs from Equation (6.26), we obtain

$$\frac{T_2}{T_1} = -\frac{Q_2}{Q_1} \quad (6.28)$$

A substitution from Equation (6.28) into Equation (6.6) yields

$$\varepsilon = 1 - \frac{T_1}{T_2} \quad (6.29)$$

$$= \frac{T_2 - T_1}{T_2} \quad (6.30)$$

Thus, we have obtained the specific functional relationship between the efficiency of a reversible Carnot engine and the thermodynamic temperatures of the heat reservoirs.

The relationship between the thermodynamic temperature scale and the ideal gas temperature scale can be derived by calculating the thermodynamic quantities for a Carnot cycle with an ideal gas as the working substance. For this purpose, we shall use  $\theta$  to represent the ideal gas temperature.

In Step I of Figure 6.1, the work performed is

$$\begin{aligned} W_I &= - \int_{V_1}^{V_2} P dV = - \int_{V_1}^{V_2} \frac{nR\theta_2}{V} dV \\ &= -nR\theta_2 \ln \frac{V_2}{V_1} \end{aligned} \quad (6.31)$$

As Step I is isothermal  $\Delta U = 0$  and

$$Q_2 = -W_I = nR\theta_2 \ln \frac{V_2}{V_1} \quad (6.32)$$

Similarly, for Step III, which is also isothermal,  $\Delta U = 0$  and

$$Q_1 = -W_{III} = nR\theta_1 \ln \frac{V_4}{V_3} \quad (6.33)$$

As Steps II and IV are adiabatic, Equation (5.46) applies, and

$$C_V \frac{d\theta}{\theta} = -nR \frac{dV}{V} \quad (6.34)$$

For an ideal gas,  $C_V$  is a function only of  $\theta$ , and both sides of Equation (6.34) can be integrated. Thus, for Step II

$$\begin{aligned} \int_{\theta_2}^{\theta_1} C_V \frac{d\theta}{\theta} &= -nR \int_{V_2}^{V_3} \frac{dV}{V} \\ &= -nR \ln \frac{V_3}{V_2} \end{aligned} \quad (6.35)$$

and for Step IV

$$\begin{aligned} \int_{\theta_1}^{\theta_2} C_V \frac{d\theta}{\theta} &= -nR \int_{V_4}^{V_1} \frac{dV}{V} \\ &= -nR \ln \frac{V_1}{V_4} \end{aligned} \quad (6.36)$$

As the integrals on the left sides of Equations (6.35) and (6.36) are equal and opposite in sign, the same must be the case for the integrals on the right sides of the two equations. Thus,

$$nR \ln \frac{V_3}{V_2} = -nR \ln \frac{V_1}{V_4}$$

or

$$\ln \frac{V_3}{V_2} = \ln \frac{V_4}{V_1} \quad (6.37)$$

Therefore

$$\frac{V_3}{V_2} = \frac{V_4}{V_1} \quad (6.38)$$

According to Equation (5.42),  $W_{II}$  and  $W_{IV}$  are equal in magnitude and opposite in sign because the limits of integration are reversed in calculating these two quantities. Because these quantities are equal and opposite, the work performed in the adiabatic steps does not contribute to the net work, which is

$$\begin{aligned} W &= W_I + W_{III} \\ &= -nR\theta_2 \ln \frac{V_2}{V_1} - nR\theta_1 \ln \frac{V_4}{V_3} \end{aligned} \quad (6.39)$$

The efficiency  $\varepsilon$  then is

$$\begin{aligned}
 \varepsilon &= \frac{-W}{Q_2} \\
 &= \frac{nR\theta_2 \ln \frac{V_2}{V_1} + nR\theta_1 \ln \frac{V_4}{V_3}}{nR\theta_2 \ln \frac{V_2}{V_1}} \\
 &= \frac{\theta_2 \ln \frac{V_2}{V_1} + \theta_1 \ln \frac{V_4}{V_3}}{\theta_2 \ln \frac{V_2}{V_1}} \tag{6.40}
 \end{aligned}$$

From Equation (6.38)

$$\frac{V_3}{V_2} = \frac{V_4}{V_1}$$

so

$$\frac{V_2}{V_1} = \frac{V_3}{V_4}$$

and

$$\ln \frac{V_4}{V_3} = -\ln \frac{V_2}{V_1} \tag{6.41}$$

Substituting from Equation (6.41) into Equation (6.40), we obtain

$$\begin{aligned}
 \varepsilon &= \frac{\theta_2 \ln \frac{V_2}{V_1} - \theta_1 \ln \frac{V_2}{V_1}}{\theta_2 \ln \frac{V_2}{V_1}} \\
 &= \frac{\theta_2 - \theta_1}{\theta_2} \tag{6.42}
 \end{aligned}$$

$$= 1 - \frac{\theta_1}{\theta_2} \tag{6.43}$$

As the efficiency of a Carnot engine is independent of the working substance, the efficiency given in Equation (6.42) for an ideal gas must be equal to that given in Equation (6.29) for any reversible Carnot engine operating between the same heat reservoirs. Thus,

$$1 - \frac{\theta_1}{\theta_2} = 1 - \frac{T_1}{T_2}$$

or

$$\frac{\theta_1}{\theta_2} = \frac{T_1}{T_2} \quad (6.44)$$

and the two temperature scales are proportional to one another. With the choice of the same reference point (the triple point of water)

$$T_{\text{tr}} = \theta_{\text{tr}} = 273.16 \text{ K} \quad (6.45)$$

the two scales become identical. Therefore, we use  $T$  to represent both the ideal gas temperature scale and the thermodynamic temperature scale.

Although the two scales are identical numerically, their conceptual bases are different. The ideal gas scale is based on the properties of gases in the limit of zero pressure, whereas the thermodynamic scale is based on the properties of heat engines in the limit of reversible operation. That we can relate them so satisfactorily is an illustration of the usefulness of the concepts so far defined.

## 6.5 THE DEFINITION OF S, THE ENTROPY OF A SYSTEM

According to Equation (6.27)

$$\frac{Q_2}{Q_1} = -\frac{T_2}{T_1}$$

Rearranging the equation, we obtain

$$\frac{Q_2}{T_2} = -\frac{Q_1}{T_1} \quad (6.46)$$

or

$$\frac{Q_2}{T_2} + \frac{Q_1}{T_1} = 0 \quad (6.47)$$

As the isothermal steps in the Carnot cycle are the only steps in which heat is exchanged, we also can write Equation (6.47) as

$$\sum_{\text{cycle}} \frac{Q}{T} = 0 \quad (6.48)$$

That we again have a quantity whose sum over a closed cycle is zero suggests that  $Q/T$  is a thermodynamic property, even though we know that  $Q$  is not a thermodynamic property. Acting on this suggestion, we define the entropy function, as Clausius did, by the equation

$$dS = \frac{DQ_{\text{rev}}}{T} \quad (6.49)$$

As was the case with energy, the definition of entropy permits only a calculation of differences, not an absolute value. Integration of Equation (6.48) provides an expression for the finite difference in entropy between two states:

$$\Delta S = S_2 - S_1 = \int_1^2 dS = \int_1^2 \frac{DQ_{\text{rev}}}{T} \quad (6.50)$$

We will demonstrate in three steps that  $\Delta S$  in Equation (6.50) is independent of the path by showing that:

1.  $dS$  is an exact differential for any substance carried through a Carnot cycle.
2.  $dS$  is an exact differential for any substance carried through any reversible cycle.
3. Entropy is a function only of the state of the system.

## 6.6 THE PROOF THAT S IS A THERMODYNAMIC PROPERTY

### Any Substance in a Carnot Cycle

If we integrate Equation (6.49) for the steps of a reversible Carnot cycle, the results are

$$\begin{aligned} \Delta S_{\text{I}} &= \int \frac{DQ_{\text{rev}}}{T_2} \\ &= \frac{1}{T_2} \int DQ_{\text{rev}} = \frac{Q_2}{T_2} \end{aligned} \quad (6.51)$$

and because Step II is adiabatic

$$\Delta S_{\text{II}} = \int \frac{DQ_{\text{rev}}}{T} = 0 \quad (6.52)$$

Similarly,

$$\Delta S_{\text{III}} = \frac{Q_1}{T_1} \quad (6.53)$$

and

$$\Delta S_{\text{IV}} = 0 \quad (6.54)$$

Thus, for the complete cycle

$$\Delta S_{\text{cycle}} = \oint dS = \frac{Q_2}{T_2} + \frac{Q_1}{T_1} \quad (6.55)$$

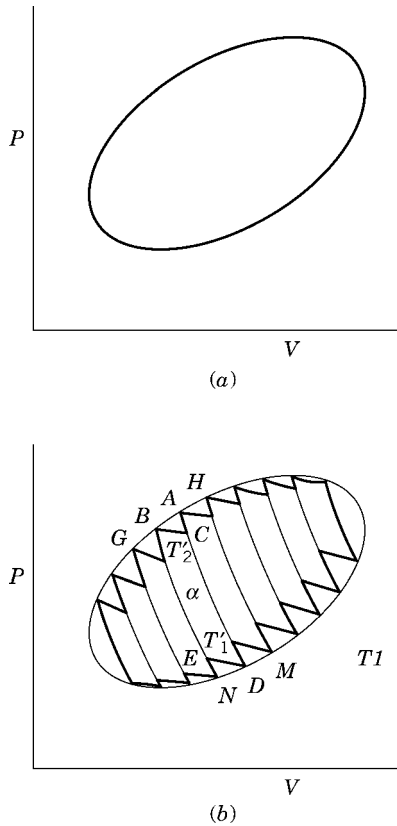
From Equation (6.47) we see that the right side of Equation (6.55) is equal to zero. Therefore

$$\Delta S_{\text{cycle}} = \oint dS = 0 \tag{6.56}$$

and  $S$  is a thermodynamic property for any substance carried through a reversible Carnot cycle.

**Any Substance in Any Reversible Cycle**

For  $S$  to be a generally useful function we must remove any specifications as to the nature of the reversible cycle through which the substance is being carried. Let us represent a general reversible cycle by the example illustrated in Figure 6.5(a). This cycle also can be approximated in Carnot cycles, as illustrated in



**Figure 6.5.** (a) A reversible cycle. (b) A reversible cycle approximated by Carnot cycles.



Figure 6.5(b), if we proceed along the heavy-lined path. In Cycle  $\alpha$ , for example, Steps BC and DE are isothermal and Steps CD and EB are adiabatic. It can be shown by the following procedure that:

$$\oint dS = 0$$

To obtain this integral, we must evaluate

$$\left(\frac{DQ}{T}\right)_{G \rightarrow B} + \left(\frac{DQ}{T}\right)_{B \rightarrow A} + \dots + \left(\frac{DQ}{T}\right)_{M \rightarrow D} + \left(\frac{DQ}{T}\right)_{D \rightarrow N} + \dots \oint dS \quad (6.57)$$

We can do this by examining the small Carnot cycles in more detail. For example, for the cycle labeled  $\alpha$ , we can state definitely, because the adiabatic steps contribute nothing to  $DQ/T$ , that

$$\left(\frac{DQ'_2}{T'_2}\right)_{B \rightarrow C} + \left(\frac{DQ'_1}{T'_1}\right)_{D \rightarrow E} = \left(\sum \frac{DQ}{T}\right)_{\text{cycle } \alpha} = 0 \quad (6.58)$$

in which the primes are used to emphasize that the quantities refer to the approximate Carnot cycle, not to the actual path of Figure 6.5(a). In the  $P$ - $V$  diagram of Figure 6.5(b) we also note that for the small area  $BACB$

$$\oint_{BACB} PdV = \text{area } BACB = -\oint_{BACB} DW = \oint_{BACB} DQ \quad (6.59)$$

The last equality follows because, for a cycle,  $\Delta U = 0$ . Hence

$$\text{area } BACB = \oint DQ = (DQ)_{B \rightarrow A} + 0 + (DQ'_2)_{C \rightarrow B} \quad (6.60)$$

where Segment AC is part of an adiabatic step. Noticing that

$$(DQ'_2)_{C \rightarrow B} = -(DQ'_2)_{B \rightarrow C} \quad (6.61)$$

We conclude that

$$(DQ)_{B \rightarrow A} = (DQ'_2)_{B \rightarrow C} + \text{area } BACB \quad (6.62)$$

A better approximation to the actual cycle of Figure 6.5(a) would be a larger number of Carnot cycles in Figure 6.5(b). In each such approximation, Equation (6.61) would be valid, but as the number of cycles used for the approximation is increased, the area  $BACB$  becomes smaller and smaller. In the limit of an

infinite number of cycles, for which the approximation to the actual cycle becomes perfect,

$$\text{area } BACB \rightarrow 0 \tag{6.63}$$

and

$$\oint (DQ)_{B \rightarrow A} = \oint (DQ'_2)_{B \rightarrow C} \tag{6.64}$$

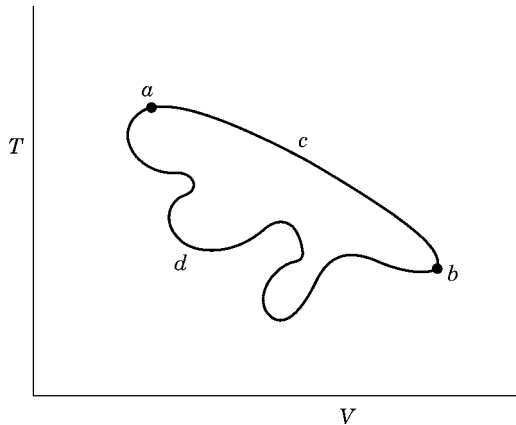
For every pair of sections,  $BA$  and  $DN$ , of the actual path we have corresponding (isothermal) pairs,  $BC$  and  $DE$ , which are parts of an approximate Carnot cycle. In the limit of an infinite number of infinitesimally small cycles, sections  $BA$  and  $DN$  can be considered isothermal at temperatures  $T$  equal to the respective temperatures  $T'$  for sections  $BC$  and  $DE$ . Hence we can write

$$\begin{aligned} \oint_{\text{actual}} dS &= \left(\frac{DQ}{T}\right)_{B \rightarrow A} + \dots + \left(\frac{DQ}{T}\right)_{D \rightarrow N} + \dots \\ &= \left(\frac{DQ'_2}{T'_2}\right)_{B \rightarrow C} + \dots + \left(\frac{DQ'_1}{T'_1}\right)_{D \rightarrow E} + \dots = 0 \end{aligned} \tag{6.65}$$

We conclude that  $dS$  is an exact differential for any reversible cycle.

### Entropy $S$ Depends Only on the State of the System

Figure 6.6 is a representation of two possible reversible paths for reaching State  $b$  from State  $a$ . We have just shown that over a reversible closed path, the entropy



**Figure 6.6.** Two reversible paths,  $acb$  and  $adb$ , from state  $a$  to state  $b$ .

change is zero, so

$$\int_{acb}^{\text{path}} dS + \int_{bda}^{\text{path}} dS = 0 \quad (6.66)$$

Hence

$$S_b - S_a = \int_{acb}^{\text{path}} dS = \int_{bda}^{\text{path}} dS = \int_{adb}^{\text{path}} dS \quad (6.67)$$

Notice that the order of limits is reversed in the right equality. Equation (6.67) emphasizes that the entropy change is the same for all arbitrary reversible paths from  $a$  to  $b$ . Thus, the entropy change  $\Delta S$  is a function only of State  $a$  and State  $b$  of the system.

## 6.7 ENTROPY CHANGES IN REVERSIBLE PROCESSES

Having established that  $dS$  is an exact differential, let us consider the value of the entropy change for several noncyclic reversible changes.

### General Statement

According to the definition of heat, whenever a system absorbs a quantity of heat  $DQ$ , the surroundings lose an equal quantity of heat. Thus,

$$DQ_{\text{sys}} = -DQ_{\text{surr}} \quad (6.68)$$

It follows that

$$\frac{DQ_{\text{sys}}}{T} + \frac{DQ_{\text{surr}}}{T} = 0 \quad (6.69)$$

Consequently, for a reversible process,

$$\int dS = 0 \quad (6.70)$$

(1) for the system plus surroundings undergoing a noncyclic process and (2) for the system undergoing a cyclic process. Several specific examples follow.

### Isothermal Reversible Changes

For isothermal reversible changes, the entropy change for the system is given by

$$\Delta S_{\text{sys}} = \int dS = \int \frac{DQ}{T} = \frac{1}{T} \int DQ = \frac{Q}{T} \quad (6.71)$$

For the specific case of the expansion of an ideal gas, because  $\Delta U = 0$ ,

$$Q = -W = nRT \ln \frac{V_2}{V_1}$$

in which  $V_2$  is the final volume and  $V_1$  is the initial volume. Hence

$$\Delta S_{\text{sys}} = \frac{Q}{T} = nR \ln \frac{V_2}{V_1} \quad (6.72)$$

If  $Q$  is the heat absorbed by the system, then  $-Q$  must be the heat absorbed by the surroundings. Therefore

$$\Delta S_{\text{surr}} = -\frac{Q}{T} \quad (6.73)$$

Hence, for the system plus surroundings

$$\Delta S_{\text{total}} = \Delta S_{\text{sys}} + \Delta S_{\text{surr}} = 0 \quad (6.74)$$

### Adiabatic Reversible Changes

In any adiabatic reversible change,  $DQ_{\text{rev}}$  equals zero. Thus,

$$\Delta S_{\text{sys}} = \Delta S_{\text{surr}} = \Delta S_{\text{total}} = 0 \quad (6.75)$$

### Reversible Phase Transitions

Any change from one phase to another—for example, from ice to water—can be carried out reversibly and at a constant temperature. Under these conditions, Equation (6.71) is applicable. Generally, equilibrium phase transitions also are carried out at a fixed pressure. As no work is expended in these transitions except against the atmosphere,  $Q$  is given by the enthalpy of transition, and

$$\Delta S_{\text{subs}} = \frac{\Delta H_{\text{trans}}}{T} \quad (6.76)$$

In these isothermal reversible phase transitions, for every infinitesimal quantity of heat absorbed by the substance, an equal quantity of heat is released by the surroundings. Consequently

$$\Delta S_{\text{surr}} = -\Delta S_{\text{subs}} \quad (6.77)$$

and again the entropy change for system plus surroundings is zero.

As a specific example of a calculation of  $\Delta S$  for a phase transition, we consider the data for the fusion of ice at  $0^\circ\text{C}$ :

$$\text{H}_2\text{O}(\text{s}, 0^\circ\text{C}) = \text{H}_2\text{O}(\text{l}, 0^\circ\text{C}), \quad \Delta H = 6008 \text{ J mol}^{-1}$$

$$\Delta S_{\text{water}} = \frac{6008}{273.15} = 21.996 \text{ J mol}^{-1}\text{K}^{-1}$$

$$\Delta S_{\text{surr}} = -21.996 \text{ J mol}^{-1}\text{K}^{-1}$$

$$\Delta S_{\text{total}} = 0$$

Earlier conventions expressed entropy changes as  $\text{cal mol}^{-1} \text{K}^{-1}$  or entropy units (eu) and sometimes as  $\text{Gibbs mol}^{-1}$ .

### Isobaric Reversible Temperature Changes

The reversible expansion of a gas (a reversible flow of work) requires that the pressure of the gas differ only infinitesimally from the pressure of the surroundings. Similarly, a reversible flow of heat requires that the temperature of the system differ only infinitesimally from the temperature of the surroundings. If the temperature of the system is to change by a finite amount, then the temperature of the surroundings must change infinitely slowly. Thus, the reversible flow of heat, like the reversible expansion of a gas, is a limiting case that can be approached as closely as desired, but it can never be reached.

If an isobaric temperature change is carried out reversibly, the heat exchanged in the process can be substituted into the expression for the entropy change, and the equations at constant pressure when no work is performed other than  $PV$  work are

$$\Delta S_{\text{sys}} = \int_{T_1}^{T_2} \frac{DQ}{T} = \int_{T_1}^{T_2} \frac{dH}{T} = \int_{T_1}^{T_2} \frac{C_P dT}{T} = \int_{T_1}^{T_2} C_P d \ln T \quad (6.78)$$

If  $C_P$  is constant

$$\Delta S = C_P \ln \frac{T_2}{T_1} \quad (6.79)$$

in which  $T_2$  is the final temperature and  $T_1$  is the initial temperature.

If the system is heated reversibly, the change in the surroundings is equal and opposite in sign to that for the system, and

$$\Delta S_{\text{sys}} + \Delta S_{\text{surr}} = \Delta S_{\text{total}} = 0$$

### Isochoric Reversible Temperature Changes

The change in entropy for temperature changes at constant volume are analogous to those at constant pressure except that  $C_V$  replaces  $C_P$ . Thus, because  $PdV = 0$ ,

$$\Delta S_{\text{sys}} = \int_{T_1}^{T_2} \frac{DQ}{T} = \int_{T_1}^{T_2} \frac{dU}{T} = \int_{T_1}^{T_2} \frac{C_V dT}{T} = \int_{T_1}^{T_2} C_V d \ln T \quad (6.80)$$

Again, the entropy change for the system plus surroundings is zero. Strictly speaking, Equations (6.78), (6.79), and (6.80) are applicable only when no phase changes or chemical reactions occur.

## 6.8 ENTROPY CHANGES IN IRREVERSIBLE PROCESSES

The definition of entropy requires that information about a reversible path be available to calculate an entropy change. To obtain the change of entropy in an irreversible process, it is necessary to discover a reversible path between the same initial and final states. As  $S$  is a state function,  $\Delta S$  is the same for the irreversible as for the reversible process.

### Irreversible Isothermal Expansion of an Ideal Gas

It has been shown [Equation (6.72)] that in the reversible isothermal expansion of an ideal gas

$$\Delta S_{\text{sys}} = nR \ln \frac{V_2}{V_1}$$

As  $S$  is a thermodynamic property,  $\Delta S_{\text{sys}}$  is the same in an irreversible isothermal process from the same initial volume  $V_1$  to the same final volume  $V_2$ . However, the change in entropy of the surroundings differs in the two types of processes. First let us consider an extreme case, a free expansion into a vacuum with no work being performed. As the process is isothermal,  $\Delta U$  for the perfect gas must be zero; consequently, the heat absorbed by the gas  $Q$  also is zero:

$$Q = \Delta U - W = 0$$

Thus, the surroundings have given up no heat and have undergone no change. Consequently,

$$\Delta S_{\text{surr}} = 0 \quad (6.81)$$

and

$$\Delta S_{\text{total}} = nR \ln \frac{V_2}{V_1} + 0 > 0 \quad (6.82)$$

In other words, for the system plus surroundings, this irreversible expansion has been accompanied by an increase in entropy.

We may contrast this result for  $\Delta S_{\text{total}}$  with that for  $\Delta U_{\text{total}}$  for an ideal gas, as mentioned in Section 5.1. In the irreversible expansion of an ideal gas,  $\Delta U_{\text{sys}} = 0$ ; the surroundings undergo no change of state ( $Q$  and  $W$  are both equal to zero), and hence,  $\Delta U_{\text{total}} = 0$ . If we consider the reversible expansion of the ideal gas,  $\Delta U_{\text{sys}}$  is also equal to zero and  $\Delta U_{\text{surr}}$  is equal to zero because  $Q = -W$ , so again  $\Delta U_{\text{total}} = 0$ . Clearly, in contrast to  $\Delta S$ ,  $\Delta U$  does not discriminate between a reversible and an irreversible transformation.

In any intermediate isothermal expansion, the work performed by the gas is not zero, but it is less in magnitude than that obtained by reversible means (see Table 5.1). As  $\Delta U$  is zero and as

$$|W_{\text{irrev sys}}| < nRT \ln \frac{V_2}{V_1} \quad (6.83)$$

it follows that

$$Q_{\text{irrev sys}} < nRT \ln \frac{V_2}{V_1} \quad (6.84)$$

Nevertheless, the entropy change for the gas still is given by Equation (6.72) because it is equal to that for the reversible process between the same endpoints. If we divide both sides of Equation (6.84) by  $T$  and apply Equation (6.72) we obtain

$$\Delta S_{\text{sys}} = nR \ln \frac{V_2}{V_1} > \frac{Q_{\text{irrev}}}{T} \quad (6.85)$$

We can combine Equation (6.72) and Equation (6.85) into the compact form

$$\Delta S \geq \frac{Q}{T} \quad (6.86)$$

in which the equality applies to the reversible isothermal change and the inequality applies to the irreversible isothermal change. In the corresponding differential form, the result is not limited to isothermal changes:

$$dS \geq \frac{DQ}{T} \quad (6.87)$$

Equation (6.87) is a condensed mathematical statement of the second law; the inequality applies to any real process, which is necessarily irreversible, and the equality applies to the limiting case of the reversible process.

For the heat exchange with the surroundings to occur reversibly (so that we can calculate the entropy change in the surroundings), we can imagine the gas to be in a vessel immersed in a large two-phase system (for example, solid–liquid) at

equilibrium at the desired temperature. The heat lost by the surroundings must be numerically equal but opposite in sign to that gained by the gas:

$$Q_{\text{surr}} = -Q_{\text{irrev sys}} \quad (6.88)$$

However, for the two-phase mixture at constant pressure and temperature, the change in entropy depends only on the quantity of heat evolved:

$$\Delta S_{\text{surr}} = \frac{Q_{\text{surr}}}{T} \quad (6.89)$$

because the change in state of the two-phase mixture during this process is a reversible one. Thus,

$$\begin{aligned} \Delta S_{\text{total}} &= \Delta S_{\text{sys}} + \Delta S_{\text{surr}} = nR \ln \frac{V_2}{V_1} + \frac{Q_{\text{surr}}}{T} \\ &= nR \ln \frac{V_2}{V_1} - \frac{Q_{\text{irrev sys}}}{T} \end{aligned} \quad (6.90)$$

From Equation (6.85)

$$nR \ln \frac{V_2}{V_1} > \frac{Q_{\text{irrev sys}}}{T}$$

and

$$\Delta S_{\text{total}} > 0 \quad (6.91)$$

### Irreversible Adiabatic Expansion of an Ideal Gas

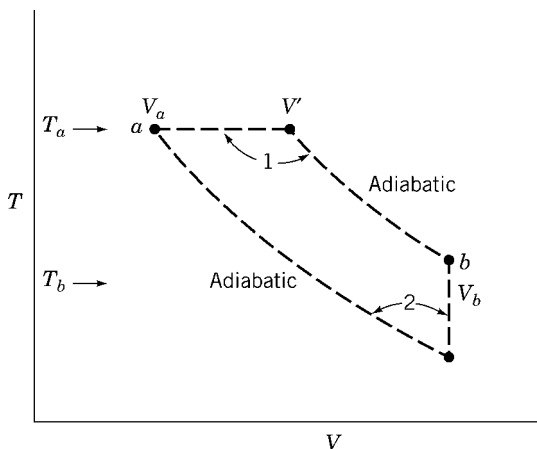
Points *a* and *b* in Figure 6.7 represent the initial and final states of an irreversible adiabatic expansion of an ideal gas. The path between is not represented because the temperature has no well-defined value in such a change; different parts of the system may have different temperatures. The inhomogeneities in the system that develop during the irreversible change do not disappear until a new equilibrium is reached at *b*.

To determine the entropy change in this irreversible adiabatic process, it is necessary to find a reversible path from *a* to *b*. An infinite number of reversible paths are possible, and two are illustrated by the dashed lines in Figure 6.7.

The first consists of two steps: (1) an isothermal reversible expansion at the temperature  $T_a$  until the volume  $V'$  is reached, and (2) an adiabatic reversible expansion from  $V'$  to  $V_b$ . The entropy change for the gas is given by the sum of the entropy changes for the two steps:

$$\Delta S_{\text{gas}} = nR \ln \frac{V'}{V_a} + 0 \quad (6.92)$$





**Figure 6.7.** Irreversible change from State  $a$  to State  $b$ . The dashed lines represent two possible reversible paths from State  $a$  to State  $b$ .

As  $V' > V_a$ , the entropy change for the gas is clearly positive for the reversible path and, therefore, also for the irreversible change.

The second path consists of [1] an adiabatic reversible expansion to  $V_b$  and a temperature  $T'$  less than  $T_b$ , and [2] an isochoric temperature increase from  $T'$  to  $T_b$ . The entropy change for the gas is again given by the sum of the changes for the two steps:

$$\Delta S_{\text{gas}} = 0 + \int_{T'}^{T_b} C_V \frac{dT}{T} \quad (6.93)$$

As  $T_b$  is greater than  $T'$ ,  $\Delta S_{\text{gas}}$  is positive.

A reversible adiabatic expansion of an ideal gas has a zero entropy change, and an irreversible adiabatic expansion of the same gas from the same initial state to the same final *volume* has a positive entropy change. This statement may seem to be inconsistent with the statement that  $S$  is a thermodynamic property. The resolution of the discrepancy is that the two changes do not constitute the same change of state; the final temperature of the reversible adiabatic expansion is lower than the final temperature of the irreversible adiabatic expansion (as in path 2 in Fig. 6.7).

### Irreversible Flow of Heat from a Higher Temperature to a Lower Temperature

Imagine the flow of heat, by means of a conductor, from a very large reservoir at a higher temperature  $T_2$  to a very large reservoir at a lower temperature  $T_1$ . By the use of large reservoirs we may consider the heat sources to be at constant temperature despite the gain or loss of a small quantity of heat  $Q$ .

To calculate the change in entropy in this irreversible flow, it is necessary to consider a corresponding reversible process. One process would be to allow an ideal gas to absorb reversibly the quantity of heat  $Q$  at the temperature  $T_2$ . The gas then can be expanded adiabatically and reversibly (therefore with no change in entropy) until it reaches the temperature  $T_1$ . At  $T_1$  the gas is compressed reversibly and evolves the quantity of heat  $Q$ . During this reversible process, the reservoir at  $T_2$  loses heat and undergoes the entropy change

$$\Delta S_{\text{hot reservoir}} = -\frac{Q}{T_2} \quad (6.94)$$

As the same change in state occurs in the irreversible process,  $\Delta S$  for the hot reservoir still is given by Equation (6.94). During the reversible process, the reservoir  $T_1$  absorbs heat and undergoes the entropy change

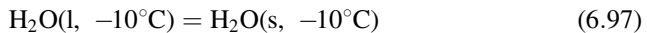
$$\Delta S_{\text{cold reservoir}} = \frac{Q}{T_1} \quad (6.95)$$

As the same change in state occurs in the irreversible process,  $\Delta S$  for the cold reservoir still is given by Equation (6.95). In the irreversible process, the two reservoirs are the only substances that undergo any changes. As  $T_2 > T_1$ , the entropy change for the system as a whole is positive:

$$\Delta S_{\text{sys}} = \Delta S_{\text{hot reservoir}} + \Delta S_{\text{cold reservoir}} = -\frac{Q}{T_2} + \frac{Q}{T_1} > 0 \quad (6.96)$$

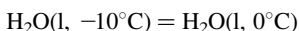
### Irreversible Phase Transitions

A convenient illustration of an irreversible phase transition is the crystallization of water at  $-10^\circ\text{C}$  and constant pressure:

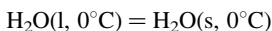


To calculate the entropy changes, it is necessary to consider a series of reversible steps leading from liquid water at  $-10^\circ\text{C}$  to solid ice at  $-10^\circ\text{C}$ . One such series might be: (1) Heat supercooled water at  $-10^\circ\text{C}$  very slowly (reversibly) to  $0^\circ\text{C}$ , (2) convert the water at  $0^\circ\text{C}$  very slowly (reversibly) to ice at  $0^\circ\text{C}$ , and (3) cool the ice very slowly (reversibly) from  $0^\circ\text{C}$  to  $-10^\circ\text{C}$ . As each of these steps is reversible, the entropy changes can be calculated by the methods discussed previously. As  $S$  is a thermodynamic property, the sum of these entropy changes is equal to  $\Delta S$  for the process indicated by Equation (6.97). The necessary calculations are summarized in Table 6.2, in which  $T_2$  represents  $0^\circ\text{C}$  and  $T_1$  represents  $-10^\circ\text{C}$ .

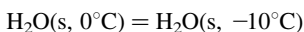
Notice that a decrease has occurred in the entropy of the water (that is,  $\Delta S$  is negative) during crystallization at  $-10^\circ\text{C}$  even though the process is irreversible. This example emphasizes again that the sign of the entropy change *for the system plus*

**TABLE 6.2. Entropy Change in Spontaneous Crystallization of Water<sup>a</sup>**

$$\Delta S_1 = \int \frac{DQ}{T} = \int \frac{C_P dT}{T} = C_P \ln \frac{T_2}{T_1} = 2.807 \text{ J mol}^{-1} \text{ K}^{-1}$$

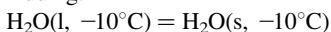


$$\Delta S_2 = \int \frac{DQ}{T} = \frac{\Delta H}{T} = \frac{-6008 \text{ J mol}^{-1}}{273.15 \text{ K}} = -21.996 \text{ J mol}^{-1} \text{ K}^{-1}$$



$$\Delta S_3 = \int \frac{DQ}{T} = \int \frac{C_P dT}{T} = C_P \ln \frac{T_1}{T_2} = -1.356 \text{ J mol}^{-1} \text{ K}^{-1}$$

Adding:



$$\Delta S_4 = \Delta S_1 + \Delta S_2 + \Delta S_3 = -20.545 \text{ J mol}^{-1} \text{ K}^{-1}$$

<sup>a</sup>This computation is based on the assumption that  $C_P$  for supercooled water and  $C_P$  for ice are independent of temperature. Actually,  $C_P$  for the supercooled liquid decreases with increasing temperature, whereas  $C_P$  for ice increases with increasing temperature. See: R. C. Dougherty and L. N. Howard, *J. Chem. Phys.* **109**, 7379 (1998).

*the surroundings*, and not merely for either alone, is related to irreversibility. To obtain  $\Delta S$  for the combination we must consider the entropy change in the surroundings, because the process described by Equation (6.96) occurs irreversibly. If we consider the water as being in a large reservoir at  $-10^\circ\text{C}$ , then the crystallization will evolve a certain quantity of heat  $Q$ , which will be absorbed by the reservoir without a significant increase in temperature. The change in state of the reservoir is the same as would occur if it were heated reversibly; hence,  $\Delta S$  is given by

$$\Delta S_{\text{reservoir}} = \int \frac{DQ}{T} = -\frac{\Delta H}{T} = -\frac{(-5619\text{J})}{263.15 \text{ K}} = 21.353 \text{ J mol}^{-1} \text{ K}^{-1} \quad (6.98)$$

in which  $\Delta H$  represents the heat of crystallization of water at  $-10^\circ\text{C}$ . Clearly, for the system plus surroundings the entropy has increased:

$$\Delta S_{\text{total}} = \Delta S_{\text{H}_2\text{O}} + \Delta S_{\text{reservoir}} = -20.545 + 21.353 = 0.808 \text{ J mol}^{-1} \text{ K}^{-1} \quad (6.99)$$

## Irreversible Chemical Reactions

As a final specific example, let us examine the particular chemical reaction



The formation of water from gaseous hydrogen and oxygen is a spontaneous reaction at room temperature, although its rate may be unobservably small in the absence of a catalyst. At 298.15 K, the heat of the irreversible reaction at constant pressure is  $-285,830 \text{ J mol}^{-1}$ . To calculate the entropy change, we must carry out the same transformation reversibly, which can be performed electrochemically with a suitable set of electrodes. Under reversible conditions, the heat of reaction for Equation (6.99) is  $-48,647 \text{ J mol}^{-1}$ . Hence, for the irreversible or reversible change

$$\Delta S_{\text{chem}} = \frac{-48,647 \text{ J mol}^{-1}}{298.15 \text{ K}} = -163.16 \text{ J mol}^{-1} \text{K}^{-1} \quad (6.101)$$

The heat absorbed by the surrounding reservoir during the irreversible reaction is 285,830 J, and this heat produces the same change in state of the reservoir as the absorption of an equal amount of heat supplied reversibly. If the surrounding reservoir is large enough to keep the temperature essentially constant, its entropy change is

$$\Delta S_{\text{reservoir}} = \frac{285,830 \text{ J mol}^{-1}}{298.15 \text{ K}} = 958.68 \text{ J mol}^{-1} \text{K}^{-1} \quad (6.102)$$

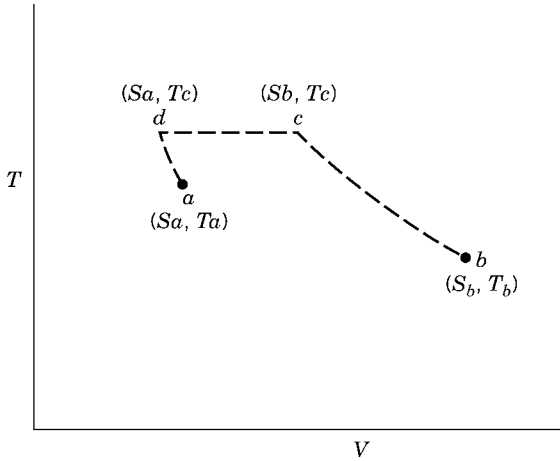
In the spontaneous formation of water, the system plus surroundings, chemicals plus environment, increases in entropy:

$$\Delta S_{\text{total}} = -163.16 + 958.68 = 795.52 \text{ J mol}^{-1} \text{K}^{-1} \quad (6.103)$$

### General Statement

In the preceding examples, irreversible processes are accompanied by an increase in total entropy. It remains to be shown that such an increase occurs generally for isolated systems. By an isolated system we mean a region large enough to include all the changes under consideration, so that no matter or heat or work (thus, no energy) is exchanged between this region and the environment. In other words, an isolated system is at constant  $U$  and  $V$ . Thus, the isolated region is adiabatic during the course of any spontaneous processes that occur within its boundaries.

Consider an irreversible process in which an isolated system goes from State  $a$  to State  $b$ . As the process is irreversible, Figure 6.8 indicates only the initial and the final states and not the path. To calculate the entropy change in going from  $a$  to  $b$ , let us complete a cycle by going from  $b$  to  $a$  by the series of reversible steps indicated by the dashed lines in Figure 6.8. The adiabatic path  $bc$  is followed to some temperature  $T_c$ , which may be higher or lower than  $T_a$ . The only requirement in fixing  $T_c$  is that it be a temperature at which an isothermal reversible process can be carried out from State  $c$  to State  $d$ . State  $d$  is chosen in such a way that a reversible adiabatic change will return the system to its initial state,  $a$ . By means of these three reversible steps, the system is returned from State  $b$  to State  $a$ . As the first and third steps in this reversible process



**Figure 6.8.** Schematic diagram of general irreversible change. The dashed line represents one possible reversible path between State  $a$  and State  $b$ .

are adiabatic, the entropy change for those steps is zero. Consequently, the entropy of State  $c$  is the same as that of State  $b$ , namely  $S_b$ . Similarly, the entropy of State  $d$  is the same as that of State  $a$ , namely  $S_a$ . However, an entropy change does occur along the path  $cd$ . As this is an isothermal reversible process

$$S_d - S_c = S_a - S_b = \frac{Q}{T_c} \quad (6.104)$$

As in the complete cycle (irreversible adiabatic process from  $a$  to  $b$  followed by the three reversible steps)

$$\Delta U_{\text{cycle}} = 0$$

it follows that

$$Q_{\text{cycle}} = -W_{\text{cycle}} \quad (6.105)$$

Furthermore, in the four steps of the cycle (Fig. 6.8) three are adiabatic (one irreversible, two reversible). Hence,  $Q_{\text{cycle}}$  is identical with  $Q$  of the isothermal step, that is,  $Q$  of Equation (6.104). If  $Q > 0$ , then  $W < 0$ ; that is, work would have been performed by the system. In other words, if  $Q$  were positive, we would have carried out a cyclical process in which heat at a constant temperature had been converted completely into work. According to the Kelvin–Planck statement of the second law, such a process cannot be carried out. Hence,  $Q$  cannot be a positive number. As  $Q$  must be either negative or zero, it follows from Equation (6.104) that

$$S_a - S_b \leq 0$$

Therefore

$$\Delta S = S_b - S_a \geq 0 \quad (6.106)$$

Thus, the entropy change for an irreversible process occurring in an isolated system is greater than or equal to zero, with the equal sign applying to the limiting case of a reversible process.

We have thus been able to show that for a closed section of space including all the changes under observation,

$$\Delta S \geq 0$$

or

$$dS \geq 0$$

for an infinitesimal change. The equality sign applies to reversible changes in isolated systems and the inequality to irreversible changes in isolated systems. As the system is isolated, infinitesimal reversible change can take place only as a result of fluctuations about an equilibrium state, so that the equality sign indicates an isolated system at equilibrium. Similarly, irreversible changes in an isolated system must be spontaneous. All finite natural changes are really irreversible; that is, for all observable changes,  $\Delta S$  is positive for the system plus surroundings.

When an infinitesimal change occurs in a system in contact with a thermal reservoir, the system and reservoir together constitute an isolated system. Then we can write

$$dS = dS_{\text{system}} + dS_{\text{reservoir}} \geq 0$$

Although the change in the system may be irreversible, the absorption of an infinitesimal amount of heat by the reservoir at constant temperature can be considered reversible, so that

$$dS_{\text{reservoir}} = \frac{dQ_{\text{reservoir}}}{T_{\text{reservoir}}}$$

The system and reservoir are at the same temperature, and

$$dQ_{\text{reservoir}} = -dQ_{\text{system}}$$

so that

$$dS_{\text{system}} - \frac{dQ_{\text{system}}}{T} \geq 0 \quad (6.107)$$

or

$$dS \geq \frac{dQ}{T} \quad (6.108)$$

Equation (6.108) is a general mathematical statement of the second law of thermodynamics, of which the infinitesimal form of Equation (6.107) is a special case. The second law does not state that the entropy of a system cannot decrease; it does state that the magnitude of the entropy decrease in the system must be less than the magnitude of the entropy increase in the surroundings. This consideration removes the apparent paradox of a living organism, which decreases its entropy as it develops into a highly organized system only with the compensating larger increase in the entropy of the surroundings caused by release of heat by the organism and the conversion of complex foodstuffs to simpler molecules like  $\text{H}_2\text{O}$  and  $\text{CO}_2$ . When crystals form spontaneously, the entropy decrease caused by the formation of an ordered structure is smaller than the concomitant increase in the entropy of the surroundings caused by the heat of crystallization.

## 6.9 GENERAL EQUATIONS FOR THE ENTROPY OF GASES

### Entropy of the Ideal Gas

We can obtain an explicit equation for the entropy of an ideal gas from the mathematical statements of the two laws of thermodynamics. It is convenient to derive this equation for reversible changes in the gas. However, the final result will be perfectly general because entropy is a state function.

In a system in which only reversible expansion work is possible, the first law can be stated as

$$dU = DQ - PdV \quad (6.109)$$

For a reversible transformation [Equation (6.49)]

$$dS = \frac{DQ}{T}$$

Substituting for  $DQ$  from Equation (6.109) into Equation (6.49), we obtain

$$dS = \frac{dU}{T} + \frac{PdV}{T} \quad (6.110)$$

or

$$dU = TdS - PdV \quad (6.111)$$

Equation (6.111) is sometimes called the combined first and second laws of thermodynamics, and this equation suggests that  $S$  and  $V$  are *natural independent variables* for  $U$ . Conversely, we can say that  $U$  and  $V$  are natural variables for  $S$ . One can also

conclude from Equation (6.111) that a natural thermodynamic definition of  $T$  is

$$T = \left( \frac{\partial U}{\partial S} \right)_V \quad (6.112)$$

For one mole of an ideal gas

$$\frac{P}{T} = \frac{R}{V_m}$$

and, from Equation (5.39),

$$dU_m = C_{V_m} dT$$

Thus

$$dS_m = \frac{C_{V_m}}{T} dT + \frac{R}{V_m} dV_m \quad (6.113)$$

If  $C_{V_m}$  is constant, this expression can be integrated to give

$$S_m = C_{V_m} \ln T + R \ln V_m + S_{m0} \quad (6.114)$$

in which  $S_{m0}$  is an integration constant characteristic of the gas. This integration constant cannot be evaluated by classic thermodynamic methods. However, it can be evaluated by statistical thermodynamic methods. For a monatomic gas,  $S_{m0}$  was formulated explicitly originally by Tetrode [3] and by Sackur [4].

### Entropy of a Real Gas

In deriving an equation for the entropy of a real gas we can start with Equation (6.110), which is general and not restricted to ideal gases. A suitable substitution for  $dU$  in Equation (6.110) can be obtained from the total differential of  $U$  as a function of  $V$  and  $T$  [Equation (4.59)]:

$$dU = \left( \frac{\partial U}{\partial T} \right)_V dT + \left( \frac{\partial U}{\partial V} \right)_T dV$$

Thus

$$dS = \frac{1}{T} \left( \frac{\partial U}{\partial T} \right)_V dT + \frac{1}{T} \left( \frac{\partial U}{\partial V} \right)_T dV + \frac{P}{T} dV \quad (6.115)$$



The entropy  $S$  also can be considered to be a function of  $V$  and  $T$ ; thus, a second equation for the total differential  $dS$  is

$$dS = \left(\frac{\partial S}{\partial T}\right)_V dT + \left(\frac{\partial S}{\partial V}\right)_T dV \quad (6.116)$$

A comparison of the coefficients of the  $dT$  terms in Equations (6.115) and (6.116) leads to the following equality:

$$\left(\frac{\partial S}{\partial T}\right)_V = \frac{1}{T} \left(\frac{\partial U}{\partial T}\right)_V = \frac{1}{T} C_V \quad (6.117)$$

It can be shown also, by a procedure to be outlined in Chapter 7, that the following relationship is valid:

$$\left(\frac{\partial S}{\partial V}\right)_T = \left(\frac{\partial P}{\partial T}\right)_V \quad (6.118)$$

Substituting from Equations (6.117) and (6.118) into Equation (6.116), we obtain

$$dS = \frac{C_V}{T} dT + \left(\frac{\partial P}{\partial T}\right)_V dV \quad (6.119)$$

Equation (6.119) can be integrated to give

$$S = \int C_V d \ln T + \int \left(\frac{\partial P}{\partial T}\right)_V dV + \text{constant} \quad (6.120)$$

To evaluate these integrals, it is necessary to know the equation of state of the gas and the dependence of  $C_{Vm}$  on temperature.

If a gas obeys the van der Waals equation of state, it can be shown that

$$S_m = \int C_{Vm} d \ln T + R \ln(V_m - b) + \text{constant} \quad (6.121)$$

## 6.10 TEMPERATURE-ENTROPY DIAGRAM

In making diagrams of various reversible cycles, it is a common practice to plot pressure as a function of volume because the area under the curve,  $\int P dV$ , gives the negative of the work performed in any step. Instead, we have used temperature and volume as coordinates because a diagram on this basis emphasizes the constancy of temperature in an isothermal process. However, it has the disadvantage that the

area is not related to the work. Gibbs (5, p. 9) pointed out that a diagram with temperature and entropy as coordinates is particularly useful because it illustrates graphically not only the work involved in a reversible cycle but also the heat. In addition, this type of diagram emphasizes the isentropic nature of an adiabatic reversible process as well as the constancy of temperature in isothermal stages. A typical diagram for a simple Carnot cycle is illustrated in Figure 6.9.

The four stages in a forward cycle are labeled by roman numerals. In Step I, the temperature is constant, heat  $Q_2$  is absorbed by the working substance, and the entropy increases from  $S_1$  to  $S_2$ . As this stage is reversible and isothermal, we have from Equation (6.51)

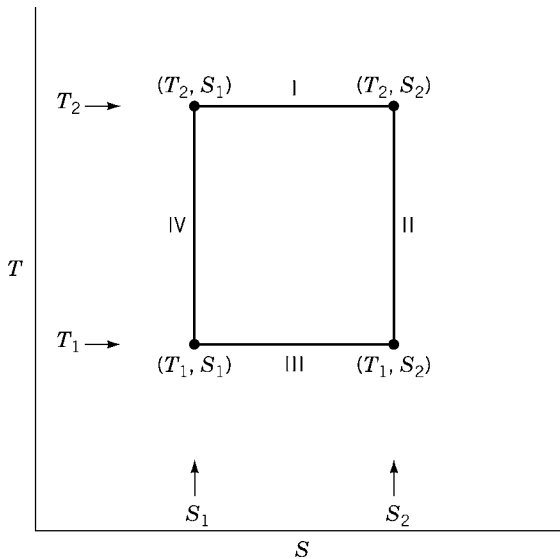
$$\Delta S_I = S_2 - S_1 = \frac{Q_2}{T_2} \quad (6.51)$$

and

$$Q_2 = T_2(S_2 - S_1) = \text{area under line I} \quad (6.122)$$

In Step II, a drop in temperature occurs in the adiabatic reversible expansion, but no change in entropy occurs. The isentropic nature of II is emphasized by the vertical line. Step III is an isothermal reversible compression, with a heat numerically equal to  $Q_1$  being evolved. As this step is reversible and isothermal, we have from Equation (6.53)

$$\Delta S_{III} = S_1 - S_2 = -(S_2 - S_1) = \frac{Q_1}{T_1} \quad (6.53)$$



**Figure 6.9.** Gibbs temperature-entropy diagram for a Carnot cycle.

and

$$Q_1 = -T_1(S_2 - S_1) = \text{negative of area under line III} \quad (6.123)$$

Thus,

$$\begin{aligned} Q &= Q_1 + Q_2 = -\text{area under line III} + \text{area under line I} \\ &= \text{area enclosed by cycle} \end{aligned}$$

In the fourth step, which is adiabatic and reversible, no entropy change occurs, but the temperature increases to the initial value  $T_2$ . As the process is cyclic

$$\Delta U = 0$$

and

$$Q_2 + Q_1 = -W$$

Therefore

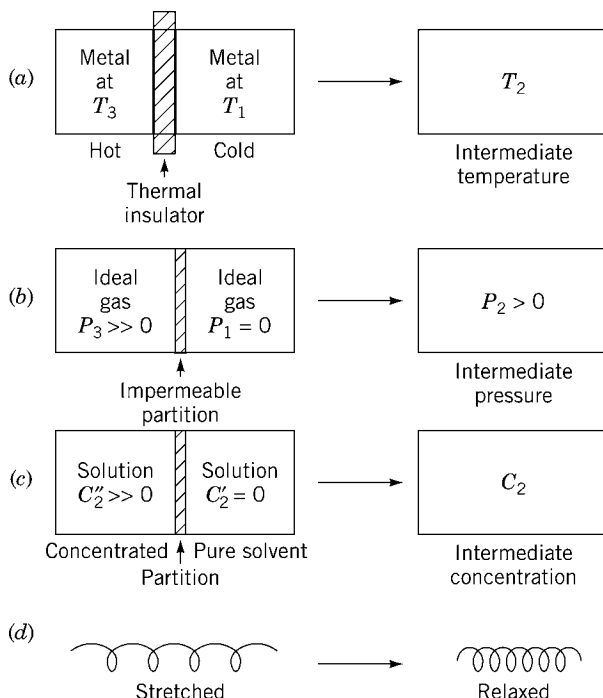
$$\begin{aligned} -W &= T_2(S_2 - S_1) - T_1(S_2 - S_1) \\ &= (T_2 - T_1)(S_2 - S_1) = \text{area enclosed by cycle} \end{aligned} \quad (6.124)$$

Thus, the work and heat involved in the cycle are both given by the area within a  $T$ - $S$  diagram, and the nature of the isothermal and isentropic steps is emphasized.

## 6.11 ENTROPY AS AN INDEX OF EXHAUSTION

To obtain a better grasp of the essential character of the entropy concept, let us examine in more detail a few transformations that occur spontaneously even though  $\Delta U = 0$  in each case (Fig. 6.10).

If two blocks of metal, one at a high temperature  $T_3$  and the other at a low temperature  $T_1$  [Fig. 6.10(a)] are separated by a perfect heat insulator, and the system as a whole is surrounded by a thermal blanket that permits no transfer of heat in or out, then no change in internal energy can occur with time. If the insulator between the blocks is removed, the hotter block will decrease in temperature and the cooler one will increase in temperature until the uniform temperature  $T_2$  is reached. This transformation is spontaneous.  $\Delta U$  is zero. But a loss of *capacity to perform work has occurred*. In the initial state, we could insert a thermocouple lead in the block at  $T_3$  and another in that at  $T_1$  and obtain electrical work. Insertion of thermocouple leads in the same positions in the double block at  $T_2$  cannot generate any work. At the conclusion of the spontaneous transformation without the thermocouple, the internal energy is still the same as that at the outset, but it is no longer in a condition where it has the capacity to do work.



**Figure 6.10.** Some processes that occur spontaneously (with  $\Delta U = 0$ ) in which loss of capacity occurs to perform work.

Similarly, if the barrier separating two ideal gases at the same temperature, one at a high pressure  $P_3$  and the other at a low pressure  $P_1$ , is removed, the high-pressure gas will move spontaneously into the low-pressure chamber [Fig. 6.10(b)]. Yet  $\Delta U = 0$ . Again a loss of *capacity to perform work has occurred*. In the initial state, we could arrange a piston with a rod extending to the outside of the containers, have the gas at  $P_3$  on one side of the piston and the gas at  $P_1$  on the other, and the piston could perform work (for example, by lifting a weight against gravity). That capacity to do work is no longer present at the conclusion of the spontaneous transformation (even if a piston were present); the character of the energy has changed.<sup>2</sup>

<sup>2</sup>The energy is “differentiated” in the separated bodies, “dedifferentiated” after thermal equilibration. The entropy is different in the differentiated state of this system than it is in the dedifferentiated state; the entropy is an index of extent of dedifferentiation. Corresponding statements can be phrased for two gases initially at different pressures, two solutions with different concentrations of  $\text{Cu}^{++}$  [Fig. 6.10(b, c)]. In a molecular visualization, a system also has a larger entropy when it is “dedifferentiated.” For example, let us place three layers of black balls at the bottom of a cubic box and carefully place three layers of white balls on top of the black layers. If the box is then buffeted around, in time the balls will achieve one of many possible random arrangements of black balls and white balls. At the outset, the system was very differentiated; at the end of the transformation, it reached a highly dedifferentiated state, one that Boltzmann associated with a larger entropy.

A similar analysis can be made for two solutions with a solute (for example, an electrolyte such as  $\text{CuSO}_4$ ) at two different concentrations being allowed to mix spontaneously during removal of a separating partition (Fig. 6.10(c)). Copper metal electrodes inserted into solutions  $C_2'$  and  $C_2''$  will generate electrical energy, but such a pair of electrodes in the same physical position after spontaneous mixing has been completed to give solution  $C_2$  can produce no work. In a very different type of system, a stretched rubber band [Fig. 6.10(d)], release of the constraint will spontaneously lead to the relaxed rubber band. In each system  $\Delta U = 0$ ; but again the capacity to perform work has been diminished.

This loss in capacity to perform the work is a property of each system illustrated in Figure 6.10, whether or not it has actually performed any work during the transformation.

Thus, we should view entropy as an index of condition or as a character of a system (perhaps somewhat analogous to a cost-of-living index or to pH as an index of acidity). It is an index of the state of differentiation<sup>2</sup> of the energy, an index of the capacity to perform work, an index of the tendency toward spontaneous change. The more a system exhausts its capacity for spontaneous change, the larger the entropy index. Hence, we should preferably say that *entropy is an index of exhaustion*; the more a system has lost its capacity for spontaneous change—the more this capacity has been exhausted—the greater is the entropy.

Thus, the second law of thermodynamics provides us with a measure of this exhaustion, the entropy change  $\Delta S$ , to be used as the fundamental criterion of spontaneity. For a closed region of space (for which, therefore,  $\Delta U = 0$ ) including all changes under observation,

$$\Delta S \geq 0 \quad (6.125)$$

with the equality sign applying to systems at equilibrium and the inequality to all systems capable of undergoing spontaneous changes.

Spontaneous transformations occur all around us all the time. Hence,  $\Delta S$ , for a section of space encompassing each such transformation and its affected surroundings, is a positive number. This realization led Clausius to his famous aphorism:

Die Energie der Welt ist konstant; die Entropie der Welt strebt einem Maximum zu (6,7),

that is,

The energy of the universe is constant, and the entropy of the universe tends to a maximum.<sup>3</sup>

<sup>3</sup>Today we would hesitate to comment on the energy or entropy of the universe, because we have no way to measure these quantities, and we would refer only to the surroundings that are observed to interact with the system. Some cosmological theorists have suggested that the increase in entropy postulated by the second law is a result of the expansion of the universe [6]. One recent set of astronomical measurements leads to a prediction that the universe will continue to expand, and another predicts that expansion will reach a maximum and reverse [7].

To a beginning student, this form of statement is frequently the source of more perplexity than enlightenment. The constancy of energy causes no difficulty of course. As energy is conserved, it fits into the category of concepts to which we attribute permanence. In thought, we usually picture energy as a kind of material fluid, and hence, even if it flows from one place to another, its conservation may be visualized readily. However, when we carry over an analogous mental picture to the concept of entropy, we immediately are faced with the bewildering realization that entropy is “being created out of nothing” whenever an increase in entropy occurs in an isolated system undergoing a spontaneous transformation.

The heart of the difficulty in “understanding” the concept of increase in entropy is a verbal one. It is difficult to dissociate the unconscious verbal implications of a word that we have used all of our lives in other contexts without critical analysis. In speaking of “increase in entropy,” we are using language appropriate for the description of material bodies. Automatically, therefore, we associate with entropy other characteristics of material bodies that are at variance with the nature of entropy and hence that are a source of confusion.

Ultimately, we must realize that entropy is essentially a mathematical function. It is a concise function of the variables of experience, such as temperature, pressure, and composition. Natural processes tend to occur only in certain directions; that is, the variables pressure, temperature, and composition change only in certain—but very complicated—ways, which are described most concisely by the change in a single function, the entropy function ( $\Delta S > 0$ ).

Some of the historical reluctance to assimilate the entropy concept into general scientific thinking, and much of the introductory student’s bewilderment, might have been avoided if Clausius had defined entropy (as would have been perfectly legitimate to do) as

$$dS' = -\frac{DQ_{\text{rev}}}{T} \quad (6.126)$$

with a negative sign instead of the positive one of Equation (6.49). With this definition, all thermodynamic consequences that have been derived from the entropy function would be just as valid except that some relations would change in sign. Thus, in place of Equation (6.123), we would find that for an isolated system,

$$\Delta S' \leq 0 \quad (6.127)$$

with the equality sign applying to reversible changes in isolated systems and the inequality to irreversible changes in isolated systems. Now, however, we would recognize that for all isolated sections of space undergoing actual changes,  $\Delta S$  is a negative number; that is, the entropy decreases. Paraphrasing Clausius, we would say, “Die Entropie der Welt strebt einem *Minimum* zu.” This statement would accord more obviously with our experience that observable spontaneous changes go in the direction that *decreases* the capacity for additional spontaneous change and that *decreases* the capacity to perform work, and that the universe (or at least the solar system) changes in time toward a state in which (ultimately) no more

spontaneous change will be possible. We need merely reiterate a few examples: Solutes always diffuse from a more concentrated solution to a dilute one; clocks tend to run down; magnets become self-demagnetized; heat always flows from a warm body to a colder one; gases always effuse into a vacuum; aqueous solutions of NaCl and AgNO<sub>3</sub> if mixed always form AgCl. Although some of these individual changes can be reversed by an outside agency, this outside agent must undergo a transformation that decreases its capacity for additional spontaneous change. It is impossible to restore every system back to its original condition. On earth, our ultimate sources of energy for work are the sun or nuclear power; in either case, these ultimate nuclear reactions proceed unidirectionally and toward the loss of capacity for additional spontaneous change.

In some respects, especially pedagogical ones, it might have been better to change the sign of the original definition of the index so that it would measure residual capacity rather than loss of capacity. However, with the development of statistical thermodynamics and the identification of entropy with the probability of a system, the original sign chosen by Clausius turns out to be the more convenient one. The universal tendency of all changes to reduce everything to a state of equilibrium may be correlated with the rearrangements of molecules from less-probable to more-probable configurations. And because more-probable configurations have more arrangements than less-probable configurations, it is appropriate that the entropy index increase with the approach of all things to a state of equilibrium.

## EXERCISES

- 6.1.** One mole of an ideal monatomic gas ( $C_{V,m} = 3/2 R$ ) at 101.33 kPa (1 atm) and 273.1 K is to be transformed to 50.67 kPa (0.58 atm) and 546.2 K. Consider the following four reversible paths, each consisting of two parts, A and B:
- i. Isothermal expansion and isobaric temperature rise
  - ii. Isothermal expansion and isochoric temperature rise
  - iii. Adiabatic expansion and isobaric temperature rise
  - iv. Adiabatic expansion and isochoric temperature rise
- a. Determine  $P$ ,  $V$ , and  $T$  of the gas after the initial step of each of the four paths. Represent the paths on a  $T$ - $V$  diagram. To facilitate plotting, some necessary data for the adiabatic expansions are given in Table 6.3. Supply the additional data required for the completion of the adiabatic curve.

**TABLE 6.3. Data for Adiabatic Expansions**

	$V/\text{dm}^3$	$P/\text{kPa}$	$T/\text{K}$
Initial	22.41	101.33	273.1
Path 3	341.77		208.2
Path 4	89.63	3.98	

- b. For each portion of each path and for each complete path, calculate the following:  $W$ , the work completed;  $Q$ , the heat absorbed by the gas;  $\Delta U$  of the gas;  $\Delta H$  of the gas;  $\Delta S$  of the gas. Tabulate your results.
- c. Note which functions in (b) have values that are independent of the path used in the transformation.

*Note:*  $R$  in joules should be used in all parts of the calculation. Check units carefully.

- 6.2. An ideal gas is carried through a Carnot cycle. Draw diagrams of this cycle using each of the following sets of coordinates:

- a.  $P, V$       d.  $U, S$   
 b.  $T, P$       e.  $S, V$   
 c.  $T, S$       f.  $T, H$

- a. By a procedure analogous to that used to obtain Equation (6.116) show that

$$\left(\frac{\partial S}{\partial V}\right)_T = \frac{P + (\partial U/\partial V)_T}{T} \quad (6.128)$$

- b. Starting with Equation (6.111), demonstrate the validity of Equation (6.118). Rearrange Equation (6.111) to

$$P = T\left(\frac{\partial S}{\partial V}\right)_T - \left(\frac{\partial U}{\partial V}\right)_T \quad (6.129)$$

Differentiate with respect to temperature at constant volume to obtain

$$\left(\frac{\partial P}{\partial T}\right)_V = \left(\frac{\partial S}{\partial V}\right)_T + T\frac{\partial^2 S}{\partial V\partial T} - \frac{\partial^2 U}{\partial V\partial T} \quad (6.130)$$

Show also that appropriate differentiation of Equation (6.111) leads to the relationship

$$\frac{\partial^2 S}{\partial V\partial T} = \frac{1}{T} \frac{\partial^2 U}{\partial V\partial T} \quad (6.131)$$

and proceed to obtain Equation (6.118)

$$\left(\frac{\partial S}{\partial V}\right)_T = \left(\frac{\partial P}{\partial T}\right)_V$$



- c. Combining the results of parts (a) and (b), show that

$$\left(\frac{\partial U}{\partial V}\right)_T = T\left(\frac{\partial P}{\partial T}\right)_V - P \quad (6.132)$$

- d. Prove that  $(\partial U/\partial V)_T = 0$  for any gas obeying a general gas law of the form

$$Pf(V) = RT$$

in which  $f(V)$  is any continuous function of volume.

- e. Derive the expression

$$\left(\frac{\partial U}{\partial V}\right)_P = C_V\left(\frac{\partial T}{\partial V}\right)_P + T\left(\frac{\partial P}{\partial T}\right)_V - P \quad (6.133)$$

- 6.4. A gas obeys the equation of state

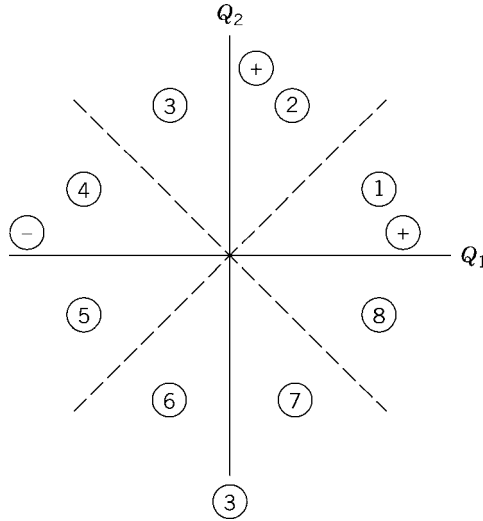
$$PV_m = RT + BP$$

in which  $B$  is a constant at all temperatures.

- a. Show that the internal energy  $U$  is a function of the temperature only.
  - b. Compute  $(\partial U/\partial V)_P$ . Compare with the value obtained for this same partial derivative for an ideal gas.
  - c. Derive an equation for the entropy of this gas that is analogous to Equation (6.114) for the ideal gas.
- 6.5. Show that the efficiency of a Carnot cycle in which any step is carried out irreversibly cannot be greater than that of a reversible Carnot cycle.
- 6.6. The heat quantities,  $Q_2$  and  $Q_1$ , absorbed by an engine during a completed Carnot cycle (in which  $Q_2$  refers to a higher temperature and  $Q_1$  to a lower temperature) can be plotted against each other using the coordinates shown in Figure 6.11. Any conceivable Carnot cycle for an engine then can be characterized by a point  $(Q_1, Q_2)$  on this plane. The figure then can be divided into eight octants. In which octant or octants would useful Carnot cycles fall?
- 6.7. Gibbs (5, p.13) has suggested that the equation

$$U_m = V_m^{-R/C_{Vm}} \exp(S_m/C_{Vm}) \quad (6.134)$$

( $C_{Vm}$  and  $R$  constants) be regarded as the fundamental thermodynamic equation of an ideal gas. With the aid of the two laws of thermodynamics, show that Equations (5.1) and (5.2) are contained implicitly in Equation (6.134).



**Figure 6.11.** Sketch of the  $Q_2$ - $Q_1$  coordinate system for possible Carnot cycles.

- 6.8.** A (reversible) Joule cycle consists of the following four steps: isobaric increase in volume, adiabatic expansion, isobaric decrease in volume, and adiabatic compression. Helium gas, with the equation of state

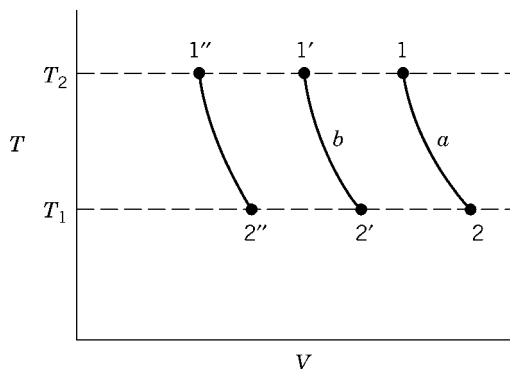
$$PV_m = RT + BP \quad (6.135)$$

(in which  $B = 15 \text{ cm}^3 \text{ mol}^{-1}$ ), is carried through a Joule cycle. Sketch diagrams of this cycle using each of the following sets of coordinates:

- |                  |                  |
|------------------|------------------|
| <b>a.</b> $P, V$ | <b>d.</b> $S, V$ |
| <b>b.</b> $U, V$ | <b>e.</b> $T, V$ |
| <b>c.</b> $T, S$ | <b>f.</b> $H, T$ |

- 6.9.** A (reversible) Sargent cycle consists of the following four steps: isochoric increase in pressure, adiabatic expansion, isobaric decrease in volume, and adiabatic compression. A gas obeying Equation (6.134) is carried through a Sargent cycle. Sketch diagrams of this cycle using each of the following sets of coordinates:

- |                  |                  |
|------------------|------------------|
| <b>a.</b> $P, V$ | <b>d.</b> $S, V$ |
| <b>b.</b> $T, V$ | <b>e.</b> $S, T$ |
| <b>c.</b> $U, V$ | <b>f.</b> $H, T$ |

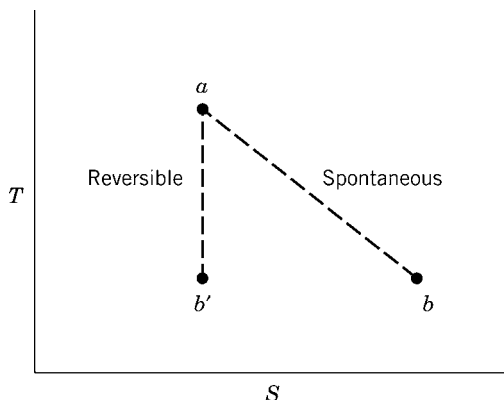


**Figure 6.12.** Possible adiabatic paths on a temperature–volume coordinate system.

- 6.10.** A reversible cycle also can be completed in three steps, such as isothermal expansion (at  $T_2$ ) from  $V_1$  to  $V_2$ , cooling (at constant  $V_2$ ) from  $T_2$  to  $T_1$ , and adiabatic compression back to the initial state.
- Sketch a diagram of this cycle using  $T$  and  $V$  as coordinates.
  - A nonideal gas obeying Equation (6.135) is carried through this cycle. Compute  $\Delta S$  for each step, and show that  $\oint dS = 0$  for the nonideal gas in this cycle. Assume that  $C_{vm}$  for this gas is a constant. Some of its other characteristics in an adiabatic process have been worked out as Exercise 5 in Chapter 5.
- 6.11.** In Figure 6.12, two adiabatic reversible paths are drawn ( $1 \rightarrow 2$  and  $1' \rightarrow 2'$ ), each one starting at the temperature  $T_2$  and ending at the temperature  $T_1$ . The points  $1, 1'$  are labeled in an order such that, for a process proceeding to the right along the isothermal  $T_1$  or the isothermal  $T_2$  (e.g.,  $1' \rightarrow 1$ ), heat is absorbed by the system.

An essential step in the Caratheodory formulation of the second law of thermodynamics is a proof of the following statement: Two adiabatics (such as  $a$  and  $b$  in Fig. 6.12) cannot intersect. Prove that  $a$  and  $b$  cannot intersect. (Suggestion: Assume  $a$  and  $b$  do intersect at the temperature  $T_1$ , and show that this assumption permits you to violate the Kelvin–Planck statement of the second law.)

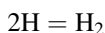
- 6.12.** For an isolated (adiabatic) system,  $\Delta S > 0$  for any natural (spontaneous) process from State  $a$  to State  $b$ , as was proved in Section 6.8. An alternative and probably simpler proof of this proposition can be obtained if we use a temperature–entropy diagram (Fig. 6.13) instead of Figure 6.8. In Figure 6.13, a reversible adiabatic process is represented as a vertical line because  $\Delta S = 0$  for this process. In terms of Figure 6.13, we can state our proposition as follows: For an isolated system, a spontaneous process from  $a$  to  $b$  must lie to the right of the reversible one, because  $\Delta S = S_b - S_a > 0$ .



**Figure 6.13.** Reversible and spontaneous changes of state on a temperature–entropy diagram.

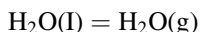
Prove that  $b$  cannot be to the left of  $b'$ ; that is, that  $\Delta S$  cannot be negative for the isolated spontaneous process. (Suggestion: Assume that  $b$  is to the left of  $b'$ , and then complete a suitable cycle back to  $a$  that allows you to violate the Kelvin–Planck statement of the second law.)

- 6.13.** A spring is placed in a large thermostat at  $27^\circ\text{C}$  and stretched isothermally and reversibly from its equilibrium length  $L_0$  to  $10 L_0$ . During this reversible stretching,  $1.00\text{ J}$  of heat is absorbed by the spring. The stretched spring, still in the constant–temperature thermostat, then is released without any restraining back-tension and is allowed to jump back to its initial length  $L_0$ . During this spontaneous process, the spring evolves  $2.50\text{ J}$  of heat.
- What is the entropy change for the stretching of the spring?
  - What is the entropy change for the collapse of the spring?
  - What is the entropy change for the universe (spring plus surrounding thermostat) for the total process, stretching plus return collapse to initial  $L_0$ ?
  - How much work was performed on the spring in the stretching process?
- 6.14.** It has been suggested that biological systems may constitute exceptions to the second law of thermodynamics, because they carry out irreversible processes that result in a decrease in the entropy of the biologic system. Comment on this suggestion.
- 6.15.** Hydrogen atoms at  $25^\circ\text{C}$  and  $101\text{ kPa}$  pressure can spontaneously form  $\text{H}_2$  gas:



However,  $\Delta S = -90.4\text{ J mol}^{-1}\text{ K}^{-1}$  for this system. As the change occurs even though  $\Delta S$  is negative, this reaction apparently violates the second law of thermodynamics. How do you explain this anomaly in terms of the second law?

- 6.16.** In carrying out a (reversible) Carnot cycle, we can place a two-phase system instead of an ideal gas into a cylinder. A suitable two-phase system is



In the first, isothermal, step with this two-phase system, one mole of liquid water is vaporized at 400 K with an absorption of 39.3 kJ. In the second, adiabatic, step, the system is expanded even more, with an accompanying decrease in temperature to 300 K. At 300 K, an isothermal compression is carried out, which is followed by an adiabatic compression to return the system to its starting point.

Assuming that this two-phase system obeys the first and second laws of thermodynamics, and given that the heat of vaporization of water at 300 K is  $43.5 \text{ kJ mol}^{-1}$ , how many grams of liquid water must condense out of the vapor in the isothermal compression step? Show your reasoning in your answer.

- 6.17.** A bottle of champagne at a temperature of 280 K is placed in a refrigerator that releases its heat into a room at a constant temperature of 300 K; the efficiency of the refrigerator is 0.5 times the corresponding Carnot efficiency. How many joules of electric energy are required to cool the bottle to a temperature of 276 K? (Assume that the heat capacity of the filled bottle is equal to that of 1 kg of water and independent of temperature.)
- 6.18.** It is estimated that  $10^6$  kwh per heating season will be required to heat a building on the shore of Lake Michigan. Electricity costs \$0.05 per kwh. Two heating systems are under consideration:
- Direct electric heating.
  - A heat pump that extracts heat from Lake Michigan at a depth with a constant temperature of  $4^\circ\text{C}$ .

Installation of b will require \$200,000 more than installation of a, which is an amount that must be borrowed at an interest rate of 6% per year. The principal must be repaid from the operational savings of the heat pump. Assume that the heat pump releases heat into the building at a temperature of  $40^\circ\text{C}$  and that the heat pump operates at 40% of the ideal Carnot efficiency. How many years will be required to repay the borrowed money?

- 6.19.** Find the natural independent variables for the enthalpy  $H$ , starting with Equation (6.111) and the definition of  $H$ , [Equation (4.3)].
- 6.20.** Two recent publications [8] determined the entropy change on binding small ligands to proteins, spontaneous reactions, and found that the entropy changes are negative. How do you reconcile these results with the second law of thermodynamics? What must be the sign and magnitude of the entropy change of the surroundings compared with the entropy change of the system? What thermodynamic change of the system is related directly to the entropy change of the surroundings?

## REFERENCES

1. E. Whittaker, *From Euclid to Eddington*, Dover, New York, 1958, pp. 58–60.
2. K. Denbigh, *The Principles of Chemical Equilibrium*, 4th ed., Cambridge University Press, Cambridge, 1981, pp. 29–32. © Cambridge University Press, 1966, 1971, 1981. Adapted with the permission of the Cambridge University Press.
3. H. Tetrode, *Ann. Physik.* **38**, 434 (1912); **39**, 225 (1912).
4. O. Sackur, *Ann. Physik.* **40**, 67 (1913).
5. *The Collected Works of J. Willard Gibbs*, Yale University Press, New Haven, 1928, reprinted 1957.
6. S. Frantschi, *Science* **217**, 593 (1982).
7. A. G. Riess, A. V. Filippenko, P. Challis, A. Clochiatti, A. Diercks, P. M. Garnavich, R. L. Gilleland, C. J. Hogan, S. Jha, R. P. Kirschner, B. Leibendgut, M. M. Phillips, D. Reiss, B. P. Schmidt, R. A. Schommer, R. C. Smith, J. Spyromilio, C. Stubbs, N. B. Suntzeff, and J. Tonry, *The Astronom. J.* **116**, 1009 (1998); D. E. Reichart, R. C. Nichol, F. J. Castander, D. J. Burke, A. K. Romer, B. P. Holden, C. A. Collins, and M. P. Ulmer, *Astrophys. J.*, **518**, 521 (1999).
8. J. M. Cole and V. M. Garsky, *Biochemistry* **40**, 5633 (2001); S. D. Sharrow, M. D. Novotny, and M. J. Stone, *Biochemistry* **42** 6302 (2003).



## CHAPTER 7

---

# EQUILIBRIUM AND SPONTANEITY FOR SYSTEMS AT CONSTANT TEMPERATURE

---

### 7.1 REVERSIBILITY, SPONTANEITY, AND EQUILIBRIUM

The second law of thermodynamics was stated in Equation (6.106) as

$$\Delta S \geq 0$$

for an isolated system, in which the equality refers to a system undergoing a reversible change and the inequality refers to a system undergoing an irreversible change.

An irreversible change is always spontaneous in an isolated system because no external force can interact with the system. Only at equilibrium can a change in an isolated system be conceived to occur reversibly. At equilibrium any infinitesimal fluctuations away from equilibrium are opposed by the natural tendency to return to equilibrium. Therefore, the criterion of reversibility is a criterion of equilibrium, and the criterion of irreversibility is a criterion of spontaneity for an isolated system.

For systems that are not isolated, it will be convenient to use the criteria of reversibility and irreversibility such as in Equation (6.108)

$$dS \geq \frac{dQ}{T}$$

that omit explicit references to changes in the surroundings. Nevertheless, we should remember that such changes are included implicitly. Equation (6.108) will be the



starting point from which to obtain criteria to decide whether a given system is at equilibrium or can be expected to change spontaneously, given sufficient time or an appropriate catalyst.

### Systems at Constant Temperature and Volume

When the value of  $DQ$  obtained from the first law is substituted into Equation (6.108), the result is

$$dS \geq \frac{dU - DW}{T} \quad (7.1)$$

If the only restraint on the system is the pressure of the environment, then the only work is mechanical work against the external pressure  $P'$ . Therefore,  $DW$  is equal to  $-P'dV$  and Equation (7.1) becomes

$$dS \geq \frac{dU + P'dV}{T} \quad (7.2)$$

or

$$dU + P'dV - TdS \leq 0 \quad (7.3)$$

As the volume is constant,  $P'dV$  equals zero and can be omitted. Because the temperature is constant,  $(-SdT)$  can be added to the left side of Equation (7.3) without changing its value. Thus,

$$dU - TdS - SdT \leq 0$$

or

$$dU - (TdS + SdT) \leq 0 \quad (7.4)$$

The terms in parentheses in Equation (7.4) are equal to the differential of the function  $TS$ , and Equation (7.4) can be written as

$$dU - d(TS) \leq 0 \quad (7.5)$$

or

$$d(U - TS) \leq 0 \quad (7.6)$$

If the temperature and volume are constant, and if the only constraint on the system is the pressure of the environment, Equation (6.106) and Equations (7.1) through (7.6) provide the criteria of equilibrium and spontaneity. The equality in Equation (7.1) applies to a reversible change, and as no exchange of work occurs with the environment, the reversible change must be in a system at equilibrium. Similarly,

the inequality in Equation (7.1) applies to an irreversible change, and in the absence of any constraint other than the pressure of the environment, this change must be spontaneous.

As  $U$ ,  $T$ , and  $S$  are state functions, the quantity  $(U - TS)$  also must be a state function. This quantity is sufficiently important that it is given the name *Helmholtz function*, or *Helmholtz free energy*, which is defined as

$$A = U - TS \quad (7.7)$$

Thus, we can state concisely that in a system at constant temperature and volume

$$dA < 0 \quad (7.8)$$

for a spontaneous change and

$$dA = 0 \quad (7.9)$$

for an infinitesimal change at equilibrium.

Alternatively, from Equation (7.2), with  $V$  constant, we obtain

$$dS \geq \frac{dU}{T}$$

or

$$dS - \frac{dU}{T} \geq 0 \quad (7.10)$$

As  $T$  is constant, we can add  $(U/T^2)dT$  to the left side of Equation (7.10) without changing its value. Then

$$dS - \frac{dU}{T} + \frac{U}{T^2}dT \geq 0$$

or

$$dS - d\left(\frac{U}{T}\right) \geq 0 \quad (7.11)$$

and

$$d\left(S - \frac{U}{T}\right) \geq 0$$

Thus, the *Massieu function* [1]

$$J = S - \frac{U}{T} \quad (7.12)$$

is also a criterion of spontaneity and equilibrium at constant temperature and volume. As  $dU$  at constant volume is equal to  $DQ$  [Equation (4.56)] and as  $DQ_{\text{system}} = -DQ_{\text{surroundings}}$ , which can be assumed to absorb heat reversibly even if the system changes irreversibly, we can see that Equation (7.10) is another way to state that

$$dS_{\text{system}} + dS_{\text{surroundings}} \geq 0 \quad (7.13)$$

### Systems at Constant Temperature and Pressure

The most familiar transformations occur under conditions of constant temperature and pressure, so it will be particularly useful to have a criterion of spontaneity and equilibrium that applies to these conditions.

We can start with Equation (7.3), in which the only restriction is that no work is performed except mechanical work against an external pressure  $P'$ . If the change is carried out at constant pressure, the pressure  $P$  of the system must equal  $P'$ , so Equation (7.3) can be written as

$$dU + PdV - TdS \leq 0 \quad (7.14)$$

If the pressure and temperature are constant,  $dP$  and  $dT$  are zero, so we can add  $-SdT$  and  $VdP$  to the left side of Equation (7.14) without changing its value:

$$dU + PdV + VdP - TdS - SdT \leq 0$$

or

$$d(U + PV - TS) \leq 0 \quad (7.15)$$

The function in parentheses in Equation (7.15) is a state function and is called the *Gibbs function*, or *Gibbs free energy*, symbolized by  $G$  [2].<sup>1</sup> Relationships for  $G$  are

$$G = U + PV - TS \quad (7.16)$$

$$= H - TS \quad (7.17)$$

and

$$dG \leq 0 \text{ (const } T, P) \quad (7.18)$$

If the temperature and pressure are constant, and if the only constraint on the system is the pressure of the environment, Equation (7.18) provides the criteria of equilibrium and spontaneity. The equality in Equation (7.18) applies to a reversible

<sup>1</sup>The letter  $F$  previously has been associated with the Gibbs function, particularly in the United States. Some older tabulations of chemical thermodynamic data use  $F$  for the function of Equation (7.17). The term *free energy* is most commonly assigned to  $G$ , but we have adopted the name *Gibbs function* to be consistent with *Helmholtz function* for  $A$  and *Planck function* for  $Y$ .

change; because the only restraint is the *constant* pressure of the environment, which is equal to the pressure of the system, the reversible change must be taking place in a system at equilibrium as a result of infinitesimal fluctuations about the equilibrium state. Similarly, the inequality in Equation (7.18) refers to an irreversible change; in the absence of any constraint other than the constant pressure of the environment, which is equal to the pressure of the system, this change must be spontaneous.

As we mentioned, changes in the environment are included implicitly in Equations (7.8), (7.9), (7.11), and (7.18), even though they are not mentioned explicitly. For example, from Equation (7.18) for a system undergoing change at constant temperature, we can write

$$dH_{\text{sys}} - TdS_{\text{sys}} \leq 0 \quad (7.19)$$

As the pressure is constant and only mechanical work is performed [Equation (4.4)],

$$dH_{\text{sys}} = DQ_{\text{sys}}$$

can be substituted in Equation (7.19) to give

$$DQ_{\text{sys}} - TdS_{\text{sys}} \leq 0 \quad (7.20)$$

From Equation (6.67),

$$DQ_{\text{sys}} = -DQ_{\text{surr}}$$

and as the entropy change in the surroundings can be assumed to be equal to  $DQ_{\text{surr}}/T$ , we obtain

$$-TdS_{\text{surr}} - TdS_{\text{sys}} \leq 0$$

or

$$TdS_{\text{surr}} + TdS_{\text{sys}} \geq 0 \quad (7.21)$$

Equation (7.21) is a restatement of the criterion for an isolated system. The choice of  $dG$  as a criterion includes an implicit consideration of changes in the environment, although only functions of the state of the system are used.

Planck [3] used a function  $Y$ , which he defined as

$$\begin{aligned} Y &= S - \frac{U + PV}{T} \\ &= S - \frac{H}{T} \end{aligned} \quad (7.22)$$

as a criterion of equilibrium and spontaneity at constant temperature and pressure. It can be observed from Equation (7.22) that  $S$  is the dominant term at high temperatures, whereas  $H/T$  is the dominant term at low temperatures.

From Equations (4.6), (6.67), and (7.22), we can see that

$$Y = S_{\text{sys}} + S_{\text{surr}} \quad (7.23)$$

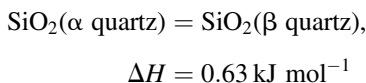
and from Equation (7.17), we can see that

$$Y = -\frac{G}{T} \quad (7.24)$$

Thus, the Planck function is a “temperature-normalized” Gibbs function.

### Heat of Reaction as an Approximate Criterion of Spontaneity

For many years, it was thought, purely on an empirical basis, that if the enthalpy change for a given reaction were negative, that is, if heat were evolved at constant pressure, the transformation could occur spontaneously. This rule was verified for many reactions. Nevertheless, numerous exceptions, exist such as the polymorphic transformation of  $\alpha$  quartz to  $\beta$  quartz at 848 K and atmospheric pressure:



which is spontaneous even though  $\Delta H$  is positive.

As, at a fixed temperature, Equation (7.17) yields the differential expression

$$dG = dH - TdS \quad (7.25)$$

or, for a macroscopic change,

$$\Delta G = \Delta H - T\Delta S \quad (7.26)$$

$\Delta H$  and  $\Delta G$  will be nearly equal if  $T\Delta S$  is small compared with  $\Delta H$ . Usually,  $T\Delta S$  is of the order of magnitude of a few thousand joules. If  $\Delta H$  is sufficiently large, perhaps above 40 kJ, the sign of  $\Delta H$  will be the same as that of  $\Delta G$ . For such relatively large values of  $\Delta H$ , the heat of reaction may be a reliable criterion of spontaneity, because if  $\Delta H$  were negative,  $\Delta G$  probably would be negative also. However,  $\Delta H$  is not the fundamental criterion, and judgments based on its sign frequently are misleading, particularly when the magnitudes involved are small.

## 7.2 PROPERTIES OF THE GIBBS, HELMHOLTZ, AND PLANCK FUNCTIONS

### The Functions as Thermodynamic Properties

As  $G$ ,  $A$ , and  $Y$  are defined by explicit equations in which the variables are functions of the state of the system, all three of these functions are thermodynamic properties and their differentials are exact. Thus, we can write

$$\begin{aligned}\oint dG &= 0 \\ \oint dA &= 0 \\ \oint dY &= 0\end{aligned}\tag{7.27}$$

### Relationships among $G$ , $Y$ , and $A$

From the definitions for  $G$  and  $A$  [Equations (7.7) and (7.16)], we can write

$$G = H - TS = U + PV - TS = (U - TS) + PV$$

The relationship between  $G$  and  $A$  is then

$$G = A + PV\tag{7.28}$$

From Equation (7.24) and Equation (7.28)

$$Y = -\frac{G}{T} = \frac{A + PV}{T}\tag{7.29}$$

### Changes in the Functions for Isothermal Conditions

Transformations at constant temperature are of frequent interest. For finite changes at a fixed temperature  $T$

$$\begin{aligned}\Delta G &= G_2 - G_1 = (H_2 - TS_2) - (H_1 - TS_1) \\ &= H_2 - H_1 - (TS_2 - TS_1) \\ &= H_2 - H_1 - T(S_2 - S_1) \\ &= \Delta H - T\Delta S\end{aligned}\tag{7.30}$$

For an infinitesimal change for which  $dT = 0$

$$\begin{aligned}dG &= dH - TdS - SdT \\ &= dH - TdS\end{aligned}\tag{7.31}$$

The equations for  $\Delta A$  and  $dA$  can be derived similarly to obtain

$$\Delta A = \Delta U - T\Delta S \quad (7.32)$$

and

$$dA = dU - TdS \quad (7.33)$$

The corresponding equations for  $\Delta Y$  and  $dY$  are

$$\Delta Y = \Delta S - \frac{\Delta H}{T} \quad (7.34)$$

and

$$dY = dS - \frac{dH}{T} \quad (7.35)$$

### Equations for Total Differentials

As the procedure is the same for both the Gibbs function and the Helmholtz function, we shall consider in detail only the derivation for the Gibbs function  $G$ . After Equation (7.14), we obtained the differential of the function, which was later to be defined as  $G$ , as

$$dG = dU + PdV + VdP - TdS - SdT \quad (7.36)$$

If we substitute from the first law expression for  $dU$ , we have

$$dG = DQ + DW + PdV + VdP - TdS - SdT \quad (7.37)$$

If the change is carried out reversibly and the only work performed is  $PdV$  work, then from Equation (6.48),

$$DQ = TdS$$

and from Equation (5.43),

$$DW = -PdV$$

When we substitute from Equations (6.48) and (5.43) into Equation (7.37) and cancel terms, we obtain

$$dG = VdP - SdT \quad (7.38)$$

By an analogous procedure, it can be shown that the total differential of the Helmholtz function is given by the expression

$$dA = -PdV - SdT \quad (7.39)$$

Although the condition of reversibility was used, for convenience, in deriving Equations (7.38) and (7.39), the result applies also to irreversible changes, because  $G$  and  $A$  are state functions. The limitation to  $PdV$  work, however, applies to the final equations. We shall consider later circumstances in which other than  $PdV$  work is performed in the presence of external fields.

The total differential of the Planck function is

$$dY = dS - \frac{dH}{T} + \frac{H}{T^2} dT \quad (7.40)$$

If we substitute  $dU + PdV + VdP$  for  $dH$ , set  $dU$  equal to  $DQ + DW$  from the first law, and choose a reversible change so that we can use  $TdS$  for  $DQ$  and  $-PdV$  for  $DW$ , the result is

$$dY = \frac{H}{T^2} dT - \frac{V}{T} dP \quad (7.41)$$

From these total differentials, which are obtained with use only of definitions and the first and second laws, we can see why  $T$  and  $P$  are *natural variables* for  $G$  and  $Y$ , whereas  $T$  and  $V$  are *natural variables* for  $A$ .

### Pressure and Temperature Derivatives of the Functions

As  $dG$  is a criterion for equilibrium and spontaneity at constant  $T$  and  $P$ , and as  $T$  and  $P$  are natural variables for  $G$ , it is useful to express the total differential when considering  $G$  as a function of  $T$  and  $P$ . That is,

$$dG = \left( \frac{\partial G}{\partial T} \right)_P dT + \left( \frac{\partial G}{\partial P} \right)_T dP \quad (7.42)$$

If we compare the coefficients of  $dP$  and  $dT$  in Equations (7.38) and (7.42), it is clear that

$$\left( \frac{\partial G}{\partial P} \right)_T = V \quad (7.43)$$

and

$$\left( \frac{\partial G}{\partial T} \right)_P = -S \quad (7.44)$$

In addition to determining the dependence of  $G$  on pressure for a substance, it is useful to determine the dependence of  $\Delta G$  on pressure for a transformation. To do so, let us represent a transformation by the equation





where  $A$  and  $B$  are reactants and  $C$  and  $D$  are products, and use Equation (7.43) to write

$$\left. \begin{aligned} \left(\frac{\partial G_A}{\partial P}\right)_T &= V_A \\ \left(\frac{\partial G_B}{\partial P}\right)_T &= V_B \\ \left(\frac{\partial G_C}{\partial P}\right)_T &= V_C \\ \left(\frac{\partial G_D}{\partial P}\right)_T &= V_D \end{aligned} \right\} \quad (7.46)$$

Subtracting the sum of the pressure coefficients for the reactants from that for the products, we obtain the desired relationship:

$$\begin{aligned} \left(\frac{\partial G_C}{\partial P}\right)_T + \left(\frac{\partial G_D}{\partial P}\right)_T - \left(\frac{\partial G_A}{\partial P}\right)_T - \left(\frac{\partial G_B}{\partial P}\right)_T \\ = V_C + V_D - V_A - V_B \end{aligned} \quad (7.47)$$

or

$$\left(\frac{\partial \Delta G}{\partial P}\right)_T = \Delta V \quad (7.48)$$

Similarly it can be shown that

$$\left(\frac{\partial \Delta G}{\partial T}\right)_P = -\Delta S \quad (7.49)$$

If the same operations are carried out using the Helmholtz function, with natural variables  $T$  and  $V$ , the results are

$$\left(\frac{\partial A}{\partial V}\right)_T = -P \quad (7.50)$$

$$\left(\frac{\partial \Delta A}{\partial V}\right)_T = -\Delta P \quad (7.51)$$

$$\left(\frac{\partial A}{\partial T}\right)_V = -S \quad (7.52)$$

$$\left(\frac{\partial \Delta A}{\partial T}\right)_V = -\Delta S \quad (7.53)$$

For  $Y$  as a function of the natural variables  $T$  and  $P$ , the results are

$$\left(\frac{\partial Y}{\partial P}\right)_T = -\frac{V}{T} \quad (7.54)$$

$$\left(\frac{\partial Y}{\partial T}\right)_P = \frac{H}{T^2} \quad (7.55)$$

$$\left(\frac{\partial \Delta Y}{\partial P}\right)_T = -\frac{\Delta V}{T} \quad (7.56)$$

$$\left(\frac{\partial \Delta Y}{\partial T}\right)_P = \frac{\Delta H}{T^2} \quad (7.57)$$

### Equations Derived from the Reciprocity Relationship

As  $G(T, P)$ ,  $A(T, V)$ , and  $Y(T, P)$  are thermodynamic properties, the reciprocity relationship [Equation (2.23)] applies. Thus, for  $G$ , we may write

$$\frac{\partial}{\partial T} \frac{\partial G}{\partial P} = \frac{\partial}{\partial P} \frac{\partial G}{\partial T} \quad (7.58)$$

According to Equations (7.43) and (7.44)

$$\left(\frac{\partial G}{\partial P}\right)_T = V$$

and

$$\left(\frac{\partial G}{\partial T}\right)_P = -S$$

Hence

$$\frac{\partial}{\partial T} \frac{\partial G}{\partial P} = \left(\frac{\partial V}{\partial T}\right)_P = \frac{\partial}{\partial P} \frac{\partial G}{\partial T} = -\left(\frac{\partial S}{\partial P}\right)_T$$

or

$$\left(\frac{\partial S}{\partial P}\right)_T = -\left(\frac{\partial V}{\partial T}\right)_P \quad (7.59)$$

By a similar set of operations on  $A$ , we can show that

$$\left(\frac{\partial S}{\partial V}\right)_T = \left(\frac{\partial P}{\partial T}\right)_V \quad (7.60)$$

Similarly, with  $Y$ , we can show that

$$\left(\frac{\partial H}{\partial P}\right)_T = V - T\left(\frac{\partial V}{\partial T}\right)_P \quad (7.61)$$

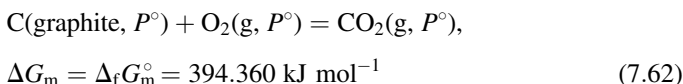
### 7.3 THE GIBBS FUNCTION AND CHEMICAL REACTIONS

In the preceding sections, we established the properties of the Gibbs, Helmholtz, and Planck functions as criteria for equilibrium and spontaneity of transformations. Thus, from the sign of  $\Delta G$ ,  $\Delta A$ , or  $\Delta Y$ , it is possible to predict whether a given chemical transformation can proceed spontaneously under the respective appropriate conditions.

#### Standard States

Like  $U$  and  $H$ ,  $G$  and  $Y$  can only be determined relative to some reference state or standard state. The standard states that have been agreed to are given in Table 7.1. The most stable form is that with the lowest value of  $G$  or the highest value of  $Y$ .

Another important concept is that of the standard change in the Gibbs function for the formation of a substance  $\Delta_f G_m^\circ$  (Tables 7.2 through 7.5). By this we shall mean the change in the Gibbs function that accompanies the formation of one mole of a substance in its standard state from its elements in their standard states, with all of the substances being at the specified temperature. For example, the standard change in the Gibbs function for the formation of  $\text{CO}_2$  given in Table 7.2 refers to the reaction



It is a consequence of this definition that  $\Delta_f G_m^\circ$  for any element is zero.

**TABLE 7.1. Standard States for Gibbs Function and Planck Function**

Standard state of solid	Pure solid in most stable form at 1 bar pressure (100 kPa) and the specified temperature
Standard state of liquid	Pure liquid in most stable form at 1 bar pressure (100 kPa) and the specified temperature
Standard state of gas	Pure gas at unit fugacity <sup>a</sup> ; for an ideal gas, fugacity is unity when pressure is 1 bar (100 kPa); at specified temperature

<sup>a</sup>The term *fugacity* has yet to be defined. Nevertheless it is used in this table because reference is made to it in future problems. For now, the standard state of a gas may be considered to be that of an ideal gas—1 bar pressure.

**TABLE 7.2. Standard Gibbs Function for Formation of a Compound at 298.15 K<sup>a</sup>**

Substance	$\Delta_f G_m^\circ / (\text{kJ mol}^{-1})$	Substance	$\Delta_f G_m^\circ / (\text{kJ mol}^{-1})$
H(g)	203.247	Methane(g)	-50.72
O(g)	231.731	Ethane(g)	-32.82
Cl(g)	105.680	Ethene(g)	68.15
Br(g)	82.396	Ethyne(g)	209.200
Br <sub>2</sub> (g)	3.110	Methanol(l)	-166.269
I(g)	70.250	Ethanol(l)	-174.780
I <sub>2</sub> (g)	19.327	Glycine(s)	-368.44
H <sub>2</sub> O(g)	-228.572	Acetic acid(l)	-389.9
H <sub>2</sub> O(l)	-237.129	Taurine(s)	-561.7
HF(g)	-273.2	Urea(s)	-197.331
HCl(g)	-95.299	SiO <sub>2</sub> (s); $\alpha$ quartz	-856.64
HBr(g)	-53.45	SiO <sub>2</sub> (s); $\alpha$ cristobalite	-855.43
HI(g)	1.70	SiO <sub>2</sub> (s); $\alpha$ tridymite	-855.26
ICl(g)	-5.46	CaSO <sub>4</sub> (s); anhydrite	-1321.790
NO(g)	86.55	CaSO <sub>4</sub> (s) · 2H <sub>2</sub> O; gypsum	-1797.28
CO(g)	-137.168	FeSO <sub>4</sub> (s); fayalite	-1479.9
CO <sub>2</sub> (g)	-394.359	MgSO <sub>4</sub> (s); forsterite	2055.1
NH <sub>3</sub> (g)	-16.45	SO <sub>2</sub> (g)	300.194
SO <sub>3</sub> (g)	-371.06		

<sup>a</sup> $\Delta_f G_m^\circ$  from The NBS Tables of Chemical Thermodynamic Properties, *J. Phys. Chem. Ref. Data* **11**, Supplement No. 2 (1982).

From Equation (7.24), we can see that

$$\Delta_f Y_m^\circ = -\frac{\Delta_f G_m^\circ}{T} = 1.3227 \text{ kJ mol}^{-1} \text{ K}^{-1}$$

The standard change in the Gibbs function  $\Delta G_m^\circ$  for any reaction is also an important quantity.  $\Delta G_m^\circ$  is the change in the Gibbs function that accompanies

**TABLE 7.3. Standard Gibbs Function for Formation of a Compound at 298.15 K<sup>a</sup>**

Substance	$\Delta_f G_m^\circ / (\text{kJ mol}^{-1})$	Substance	$\Delta_f G_m^\circ / (\text{kJ mol}^{-1})$
CO(g)	-137.2	Propene(g)	62.2
CO <sub>2</sub> (g)	-394.4	Propane(g)	-24.3
Methane(g)	-50.5	1-Butene(g)	70.4
Methanol(g)	-162.2	Butane(g)	-15.9
Ethyne(g)	210.7	Benzene(g)	129.8
Ethene(g)	68.5	Cyclohexane(g)	32
Acetic acid(g)	-382.9	Toluene(g)	122.3
Ethane(g)	-31.9	o-Xylene(g)	122.1
Ethanol(g)	-167.7	m-Xylene(g)	118.9
		p-Xylene(g)	121.5

<sup>a</sup> $\Delta_f G_m^\circ$  from M. Frenkel, K. N. Marsh, R. C. Wilhoit, G. J. Kabo, G. N. Roganov, *Thermodynamics of Organic Compounds in the Gas State*, Thermodynamics Research Center, College Station, TX, 1994.

**TABLE 7.4. Standard Gibbs Function for Formation of a Compound at 298.15 K<sup>a</sup>**

Substance	$\Delta_f G_m^\circ / (\text{kJ mol}^{-1})$	Substance	$\Delta_f G_m^\circ / (\text{kJ mol}^{-1})$
Br <sub>2</sub> (g)	3.1	CuSO <sub>4</sub> (s)	-662.3
I <sub>2</sub> (g)	19.3	CuSO <sub>4</sub> · 5H <sub>2</sub> O(s) chalcant	-1880.0
C(diamond)	2.9	CaSO <sub>4</sub> · 2H <sub>2</sub> O(s); gypsum	-1797.0
CO(g)	-137.1	CaSO <sub>4</sub> (s); anhydrite	-1321.8
CO <sub>2</sub> (g)	-394.4	CaSiO <sub>3</sub> (s); wollastinite	-1549.0
NO <sub>2</sub> (g)	51.2	SiO <sub>2</sub> ; α quartz	-856.3
SO <sub>2</sub> (g)	-300.1	SiO <sub>2</sub> ; α tridymite	-854.6
SO <sub>3</sub> (g)	-371.0	SiO <sub>2</sub> ; α cristobalite	-853.8
S(monoclinic)	0.0	CH <sub>4</sub> (g)	-50.7
MgO(s)	-569.3	NH <sub>3</sub> (g)	-16.4
Mg <sub>2</sub> SiO <sub>4</sub> (s)	2053.6	Fe <sub>2</sub> SiO <sub>4</sub> ; fayalite	-1379.1
H <sub>2</sub> O(l)	-237.1	H <sub>2</sub> O(g)	-228.6

<sup>a</sup> $\Delta_f G_m^\circ$  from R. A. Robie and B. S. Hemingway, *Thermodynamic properties of minerals and related substances*, U. S. Geological Survey Bulletin 2131, 1995.

**TABLE 7.5. Standard Gibbs Function for the Formation of a Compound at 298.15 K<sup>a</sup>**

Substance	$\Delta_f G_m^\circ / \text{kJ mol}^{-1}$
HBr(g)	-53.513
CO(g)	-137.163
CO <sub>2</sub> (g)	-394.389
HF(g)	-274.646
H <sub>2</sub> O(g)	-228.582
NH <sub>3</sub> (g)	-16.367
HCl(g)	-95.300

<sup>a</sup> $\Delta_f G_m^\circ$  from M. W. Chase, Jr., *NIST-JANAF Thermochemical Tables*, 4th ed., *J. Phys. Chem. Reference Data* Monograph No: 9, 1998.

one mole (see Table 2.1) of the conversion of reactants in their standard states to products in their standard states. As the Gibbs function is a thermodynamic property and does not depend on the path used to carry out a transformation, a simple addition of reactions and their Gibbs functions can be used to obtain

$$\Delta G_m^\circ = \sum v \Delta_f G_m^\circ (\text{products}) - \sum v \Delta_f G_m^\circ (\text{reactants}) \quad (7.63)$$

where the  $v$ 's represent the stoichiometric coefficients in the reaction.

## 7.4 PRESSURE AND TEMPERATURE DEPENDENCE OF $\Delta G$

When studying geological problems, we are particularly interested in reactions that take place over a wide range of pressures and temperatures. Therefore, we are

interested in the pressure and temperature dependence of  $\Delta G$ . According to Equations (7.48) and (7.49):

$$\left(\frac{\partial \Delta G}{\partial P}\right)_T = \Delta V \quad \text{and} \quad \left(\frac{\partial \Delta G}{\partial T}\right)_P = -\Delta S$$

Thus, the total differential for  $\Delta G$  can be written as

$$d(\Delta G) = \left(\frac{\partial \Delta G}{\partial T}\right)_P dT + \left(\frac{\partial \Delta G}{\partial P}\right)_T dP = -(\Delta S)dT + (\Delta V)dP \quad (7.64)$$

If Equation (7.64) is integrated from a reference temperature and pressure of 298 K and  $P = P^\circ$  to any temperature  $T'$  and pressure  $P'$ , we obtain

$$\int_{P=P^\circ, T=298}^{P', T'} d(\Delta G) = \int_{P=P^\circ, T=298}^{P=P^\circ, T'} (-\Delta S)dT + \int_{P=P^\circ, T}^{P', T'} (\Delta V)dP \quad (7.65)$$

From Equation (7.65), we can see that the first integral on the right side is integrated with respect to temperature at constant pressure  $P^\circ$  and that the second integral on the right side is integrated with respect to pressure at constant temperature  $T'$ . Thus, the temperature dependence and the pressure dependence can be dealt with independently.

**Temperature Dependence.** A simple expression for the temperature dependence is found if we remember that [Equation (7.26)]

$$\Delta G(P = P^\circ, T') = \Delta H(P = P^\circ, T') - T' \Delta S(P = P^\circ, T')$$

and that from Equation (4.55)

$$\left(\frac{\partial \Delta H}{\partial T}\right)_P = \Delta C_P \quad (7.66)$$

and from Equation (6.78)

$$\left(\frac{\partial \Delta S}{\partial T}\right)_P = \frac{\Delta C_P}{T} \quad (7.67)$$

In view of Equation (7.66) and Equation (7.67), we can write Equation (7.26) as

$$\begin{aligned} \Delta G(P = P^\circ, T') = \Delta H(P = P^\circ, 298 \text{ K}) + \int_{T=298}^{T'} (\Delta C_P) dT \\ - T' \Delta S(P = P^\circ, 298 \text{ K}) - T' \int_{T=298}^{T'} \frac{\Delta C_P}{T} dT \end{aligned} \quad (7.68)$$

in which the integrations with respect to temperature are carried out at  $P = P^\circ$ .

**Pressure Dependence.** As [Equation (7.48)]

$$\left( \frac{\partial \Delta G}{\partial P} \right)_T = \Delta V_T$$

in which the subscript  $T$  indicates that  $\Delta V$  is a function of  $T$ , we can write

$$\Delta G(P', T') = \Delta G(P = P^\circ, T') + \int_{P=P^\circ}^{P'} (\Delta V)_{T'} dP \quad (7.69)$$

in which integration with respect to  $P$  is carried out at temperature  $T'$  and  $(\Delta V)_{T'}$  must be known at every temperature  $T'$  at which the integration is carried out.

**General Expression.** If we add Equation (7.68) and Equation (7.69), we obtain

$$\begin{aligned} \Delta G(P', T') = \Delta H(P = P^\circ, 298 \text{ K}) - T' \Delta S(P = P^\circ, 298 \text{ K}) \\ + \int_{T=298}^{T'} (\Delta C_P) dT - T' \int_{T=298}^{T'} \frac{\Delta C_P}{T} dT + \int_{P=P^\circ}^{P'} (\Delta V)_{T'} dP \end{aligned} \quad (7.70)$$

It can be seen from Equation (7.70) that to calculate  $\Delta G$  at any temperature and pressure we need to know values of  $\Delta H$  and  $\Delta S$  at standard conditions ( $P = 100$  kPa,  $T = 298$  K), the value of  $\Delta C_P$  as a function of temperature at the standard pressure, and the value of  $\Delta V_T$  as a function of pressure at each temperature  $T'$ . Thus, the temperature dependence of  $\Delta C_P$  and the temperature and pressure dependence of  $\Delta V_T$  are needed. If such data are available in the form of empirical equations, the required integrations can be carried out analytically. If the data are available in tabular form, graphical or numerical integration can be used. If the data are not available, an approximate result can be obtained by assuming  $\Delta C_P$  and  $\Delta V_T$  are constant

over the range of interest. The approximate result if both are assumed constant is

$$\begin{aligned}\Delta G(P', T') &= \Delta H(P = P^\circ, 298 \text{ K}) - T' \Delta S(P = P^\circ, 298 \text{ K}) \\ &\quad + \Delta C_p(P = P^\circ)[T' - 298] - T \Delta C_p(P = P^\circ)[\ln T' - \ln(298)] \\ &\quad + (\Delta V)(P' - P^\circ)\end{aligned}\quad (7.71)$$

## 7.5 USEFUL WORK AND THE GIBBS AND HELMHOLTZ FUNCTIONS

Thus far we have observed that the Gibbs and Planck functions provide the criteria of spontaneity and equilibrium in isothermal changes of state at constant pressure. If we extend our analysis to systems in which other constraints are placed on the system, and therefore work other than mechanical work can be performed, we find that the Gibbs and Helmholtz functions also supply a means for calculating the maximum magnitude of work obtainable from an isothermal change.

### Isothermal Changes

We can begin with Equation (7.1) as a statement of the combined first and second laws, which were rearranged to

$$dU - DW - TdS \leq 0 \quad (7.72)$$

As we are concerned with isothermal changes,  $-SdT$  can be added to the left side of Equation (7.74) without changing its value:

$$dU - TdS - SdT - DW \leq 0$$

or

$$d(U - TS) - DW \leq 0$$

or

$$dA - DW \leq 0$$

or

$$dA \leq DW \quad (7.73)$$

As constraints other than the constant pressure of the environment are now considered, the one-to-one relationships between reversibility and equilibrium on the one hand and irreversibility and spontaneity on the other hand are no longer valid. A spontaneous change of state or the opposite change, a nonspontaneous change, can be carried out reversibly by the appropriate adjustment of a constraint, such as an electrical voltage. As before, the inequality applies to an irreversible process and the equality to a reversible process. If the change of state is spontaneous,  $dA$  is negative, work can be performed on the surroundings, and  $DW$  is negative. The



value for  $dA$  is the same for a change of state whether it is carried out reversibly or irreversibly. The reversible work,  $DW_{\text{rev}}$ , then is equal to  $dA$ , whereas the irreversible work,  $DW_{\text{irrev}}$ , is algebraically greater than  $dA$  but smaller in magnitude. For a macroscopic change, we can write

$$\left. \begin{aligned} \Delta A &= W_{\text{rev}} \\ \Delta A &< W_{\text{irrev}} \end{aligned} \right\} \quad (7.74)$$

The change in the Helmholtz function thus provides a *limiting* value for the magnitude of the *total* work (including work against the pressure of the atmosphere) obtainable in any spontaneous, isothermal process. That is,

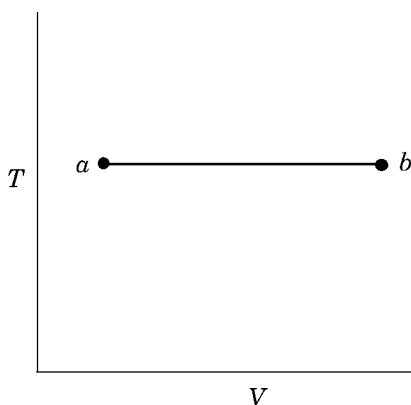
$$|W_{\text{rev}}| > |W_{\text{irrev}}| \quad (7.75)$$

and the magnitude of the reversible work is a maximum. If the change of state is not spontaneous,  $dA$  is positive, work must be performed on the system to produce the change, and  $DW$  is positive. Then  $W_{\text{rev}}$  is the minimum work required to carry out a nonspontaneous change of state.

An interesting alternative demonstration of Equation (7.75) can be carried out on the basis of isothermal cycles and of the Kelvin–Planck statement of the second law. Consider two possible methods of going from State  $a$  to State  $b$ , a spontaneous change of state, in an isothermal fashion (Fig. 7.1): (1) a reversible process and (2) an irreversible process.

For each path, the first law of thermodynamics is valid:

$$\begin{aligned} \Delta U_{\text{rev}} &= Q_{\text{rev}} + W_{\text{rev}} \\ \Delta U_{\text{irrev}} &= Q_{\text{irrev}} + W_{\text{irrev}} \\ \Delta U_{\text{rev}} &= \Delta U_{\text{irrev}} \end{aligned}$$



**Figure 7.1.** An isothermal process.

**TABLE 7.6. Isothermal Cycle**

	Irreversible Process (Forward)	Reversible Process (Backward)	Net for Both Processes
Heat absorbed	$Q_{\text{irrev}}$	$-Q_{\text{rev}}$	$Q_{\text{irrev}} - Q_{\text{rev}} > 0$
Work performed	$W_{\text{irrev}}$	$-W_{\text{rev}}$	$W_{\text{irrev}} - W_{\text{rev}} < 0$

Both processes begin and end at the same points, and  $U$  is a state function; thus,

$$Q_{\text{rev}} + W_{\text{rev}} = Q_{\text{irrev}} + W_{\text{irrev}}$$

or

$$Q_{\text{rev}} - Q_{\text{irrev}} = -(W_{\text{rev}} - W_{\text{irrev}}) \quad (7.76)$$

Let us *assume* that the spontaneous irreversible process gives work of a greater magnitude than the spontaneous reversible one. In that case

$$|W_{\text{irrev}}| > |W_{\text{rev}}|$$

and, from Equation (7.78), as  $W$  is negative for both alternatives,

$$Q_{\text{irrev}} > Q_{\text{rev}}$$

Let us use the irreversible process (*which goes in only one direction*) to carry the system from State  $a$  to State  $b$  and the reversible process to return the system to its initial state. We can construct a table for the various steps (Table 7.6). As we can see from Table 7.6, the net result is that a positive amount of heat has been absorbed and work has been performed on the surroundings in an isothermal cycle. However, such a consequence is in contradiction to the Kelvin–Planck statement of the second law of thermodynamics, which denies the possibility of converting heat from a reservoir at constant temperature into work without some accompanying changes in the reservoir or its surroundings. In the postulated cyclical process, no such accompanying changes have occurred. Hence, the original assumption is incorrect and the irreversible work cannot be greater in magnitude than the reversible work:

$$|W_{\text{rev}}| \geq |W_{\text{irrev}}| \quad (7.77)$$

Thus, the reversible work is a limiting maximum value for the magnitude of work obtainable in an isothermal change, with the equality applying to the limit when the process becomes reversible.

### Changes at Constant Temperature and Pressure

Equation (7.74) can be rewritten to include explicit reference to  $DW_{\text{net}}$ , the net useful (non- $PdV$ ) work, by substituting  $-P'dV + DW_{\text{net}}$  for  $DW$ . That is,

$$dU + P'dV - DW_{\text{net}} - TdS \leq 0 \quad (7.78)$$

For a constant-pressure process,  $PdV$  can be substituted for  $P'dV$ , and  $VdP$  can be added without changing the value of the expression. As the temperature is constant,  $-SdT$  also can be added. With these additions and substitutions, Equation (7.78) becomes

$$dU + PdV + VdP - TdS - SdT \leq DW_{\text{net}}$$

or [see Equation (7.15)]

$$dG \leq DW_{\text{net}} \quad (7.79)$$

For a spontaneous change at constant  $T$  and  $P$ ,  $dG$  is negative, work can be obtained, and  $DW_{\text{net}}$  is negative. The value of  $dG$  is the same for a given change of state whether it proceeds irreversibly in the absence of additional constraints, or whether it follows a reversible path or proceeds irreversibly when subjected to additional constraints (for example, electrical). If the process is reversible, the equality in Equation (7.79) applies. If the process is irreversible, the inequality applies. Thus  $DW_{\text{net,rev}}$  is equal to  $dG$ , whereas  $DW_{\text{net,irrev}}$  is greater algebraically than  $dG$  but smaller in magnitude. For a macroscopic change, we can write

$$\left. \begin{array}{l} \Delta G = W_{\text{net,rev}} \\ \Delta G < W_{\text{net,irrev}} \end{array} \right\} \quad (7.80)$$

If the change of state is spontaneous,  $|\Delta G|$  is equal to the maximum magnitude of non- $PdV$  work that can be obtained. If the change of state is nonspontaneous,  $\Delta G$  is equal to the minimum non- $PdV$  work that must be performed to carry out the change.

### Relationship between $\Delta H_P$ and $Q_P$ When Useful Work is Performed

We repeatedly have used the relationship [Equation (4.6)]

$$\Delta H_P = Q_P$$

but always with the stipulation that pressure on the system is constant and that no work exists other than expansion work. Most chemical reactions are carried out under these conditions; hence, the heat of a reaction has been valuable as a measure of the enthalpy change. If nonatmospheric work also is being obtained, Equation (4.6) is no longer valid. The value of  $Q_P$  under these conditions can be obtained as follows. From the first law

$$\begin{aligned} dU &= DQ + DW \\ &= DQ - P'dV + DW_{\text{net}} \end{aligned}$$

For a constant-pressure process,  $PdV$  can be substituted for  $P'dV$ , so that

$$dU + PdV = DQ + DW_{\text{net}}$$

But at constant pressure, from Equation (4.3),

$$dH = dU + PdV$$

and we have, explicitly indicating the constancy of pressure,

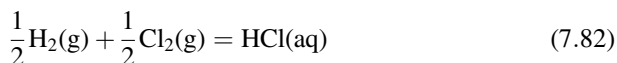
$$\text{or } \left. \begin{aligned} dH_P &= DQ_P + DW_{\text{net}} \\ \Delta H_P &= Q_P + W_{\text{net}} \end{aligned} \right\} \quad (7.81)$$

Only when  $W_{\text{net}}$  is equal to zero is Equation (4.6) applicable.

### Application to Electrical Work

Electrical work is among the most common kinds of nonmechanical work obtained from chemical transformations. The ordinary storage battery and the electric cell are examples of systems in which electrical work is produced from chemical transformations. In both cases, the change in the Gibbs function gives the limiting value of the magnitude of electrical work; in a spontaneous process, the actual value is always less in magnitude than the decrease in the Gibbs function.

An example in which the relationships can be explored in some detail is the formation at constant  $T$  and  $P$  of one mole of aqueous HCl from the gaseous elements  $\text{H}_2$  and  $\text{Cl}_2$ :



If the gaseous mixture is exposed to a photochemical stimulus in the absence of any other constraints, the reaction proceeds spontaneously and irreversibly. Thus,

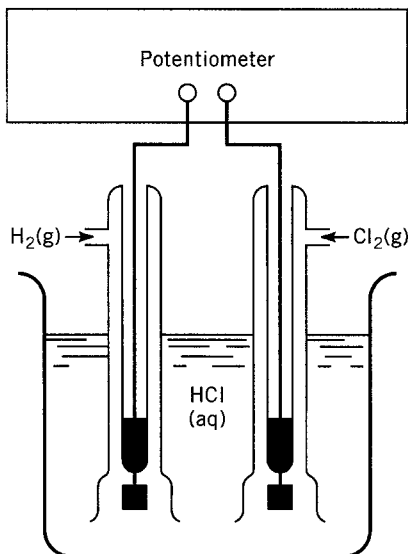
$$dG_{\text{m}} < 0$$

and

$$DW_{\text{net}} = 0$$

The reaction also can be carried out reversibly if additional constraints are placed on the system, as in the cell illustrated by Figure 7.2. The  $\text{H}_2$  and  $\text{Cl}_2$  electrodes are connected to a potentiometer. If the electromotive force of the cell is opposed by the electromotive force of the potentiometer, which is maintained at an infinitesimally lower value than that of the  $\text{H}_2$ - $\text{Cl}_2$  cell, then the conversion to HCl can be carried out reversibly, although it would take an infinitely long time to obtain one mole of reaction. The change in the Gibbs function is the same for either the reversible or the explosively spontaneous path for carrying out the transformation, because the initial and final states are the same in both cases. However, the amount of useful (electrical) work is different, and, for the reversible path

$$DW_{\text{net}} \neq 0$$



**Figure 7.2.** Formation of aqueous HCl in a reversible manner.

When electrical work is obtained from the reaction under reversible conditions, that is, against a counterpotential only infinitesimally smaller than that of the cell, then

$$\begin{aligned} W_{\text{elec}} &= W_{\text{net,rev}} \\ &= (\text{potential difference}) \times (\text{charge transferred}) \\ &= (\mathcal{E})(-n\mathcal{F}) \end{aligned} \quad (7.83)$$

in which  $\mathcal{E}$  is the counterpotential, which is equal to the cell potential under reversible conditions,  $\mathcal{F}$  is the charge of one mole of protons, and  $n$  is the stoichiometric coefficient of the electron in each half-reaction of the cell reaction. It follows from Equation (7.80) and Equation (7.83) that

$$\Delta G_{\text{m}} = -n\mathcal{F}\mathcal{E} \quad (7.84)$$

The potentiometer also can be kept at a finitely lower potential than the cell. In this case, the reaction would proceed spontaneously, but the work obtained would be less in magnitude than the value given in Equation (7.83). If the potentiometer is kept at a potential greater than that of the cell, the reverse of Equation (7.82) will occur, irreversibly, with  $\Delta G$  positive and  $W_{\text{net}}$  positive. Then  $W_{\text{net,rev}}$  is the minimum work required to reverse the process in Equation (7.82).

### Gibbs–Helmholtz Equation

It is of interest to consider the temperature dependence of the potential of an electrochemical cell. For an isothermal reaction [Equation (7.26)]

$$\Delta G_{\text{m}} = \Delta H_{\text{m}} - T\Delta S_{\text{m}}$$

From Equation (7.49)

$$\Delta S_m = -\left(\frac{\partial \Delta G_m}{\partial T}\right)_P$$

It follows that

$$\Delta G_m = \Delta H_m + T\left(\frac{\partial \Delta G_m}{\partial T}\right)_P \quad (7.85)$$

Equation (7.85) frequently is called the *Gibbs–Helmholtz equation*. From it, the temperature coefficient of the free energy change  $(\partial \Delta G_{m,P,T}/\partial T)_P$  can be obtained if  $\Delta G_m$  and  $\Delta H_m$  are known. By differentiating Equation (7.83), we obtain

$$\left(\frac{\partial \Delta G_m}{\partial T}\right)_P = -n\mathcal{F}\left(\frac{\partial \mathcal{E}}{\partial T}\right)_P \quad (7.86)$$

because  $n$  and  $\mathcal{F}$  are temperature-independent quantities. Substitution of Equations (7.83) and (7.86) into Equation (7.85) gives

$$-n\mathcal{F}\mathcal{E} = \Delta H_m - n\mathcal{F}T\left(\frac{\partial \mathcal{E}}{\partial T}\right)_P \quad (7.87)$$

or, on rearrangement, an alternative form of the Gibbs–Helmholtz equation

$$\Delta H_m = n\mathcal{F}\left[T\left(\frac{\partial \mathcal{E}}{\partial T}\right)_P - \mathcal{E}\right] \quad (7.88)$$

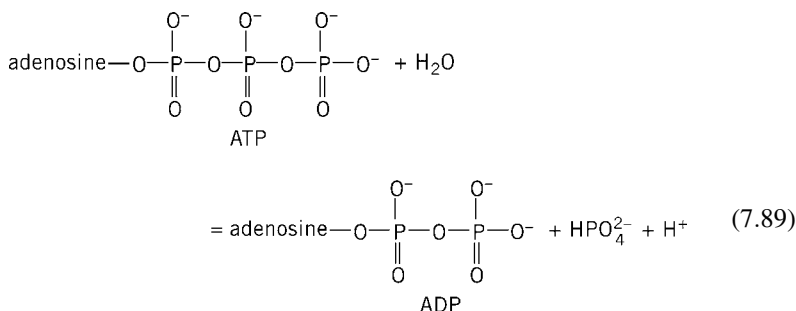
so that  $\Delta H_m$  can be obtained from measurements of cell potential and its temperature derivative.

### The Gibbs Function and Useful Work in Biologic Systems

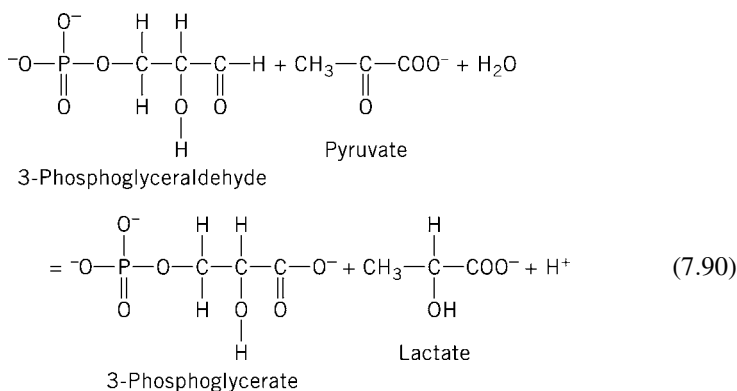
As biologic systems operate at constant temperature and pressure, the change in the Gibbs function of a reaction occurring in a biologic system is a measure of the maximum magnitude of the net useful work that can be obtained from the reaction.

**Biosynthetic Work.** One primary function in a biologic system of spontaneous reactions, which occur with a decrease in the Gibbs function (exergonic reactions), is to make possible synthetic nonspontaneous reactions, which occur with an increase in the Gibbs function (endergonic reactions). The statement about maximum work can be paraphrased for this case: An exergonic reaction can make an endergonic reaction feasible if the increase in the Gibbs function of the endergonic reaction is smaller than the decrease in the Gibbs function of the exergonic reaction. In fact, such a coupling of exergonic and endergonic reactions can occur *only if* the two reactions have a common intermediate.

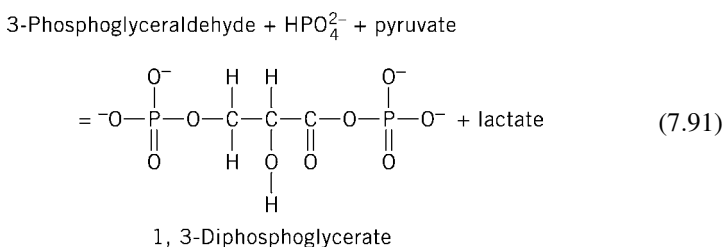
The hydrolysis of adenosine triphosphate (ATP), an exergonic reaction [Equation (7.89)], is frequently used in biologic systems to drive endergonic reactions. The value of  $\Delta G_m^\circ$  for this reaction is  $-29,300 \text{ J mol}^{-1}$ .



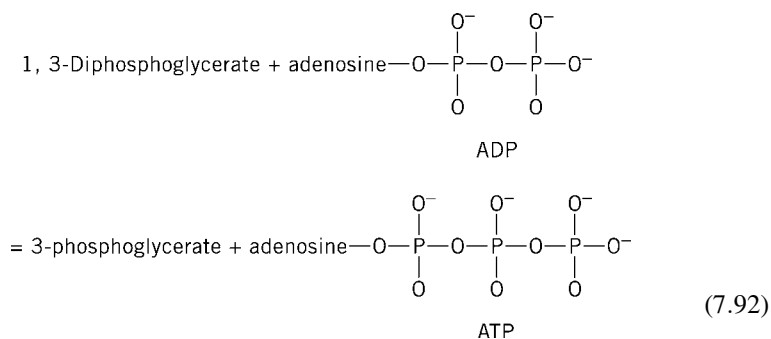
For ATP to carry out this function, it has to be produced from adenosine diphosphate (ADP) in an endergonic reaction that must be driven by another exergonic metabolic reaction. One exergonic reaction step that occurs in the overall oxidation of glucose in the cell is the oxidation of 3-phosphoglyceraldehyde to 3-phosphoglycerate by pyruvate, for which  $\Delta G_m^\circ = -29,300 \text{ J mol}^{-1}$ .



As it occurs in the cell, the reaction (Equation 7.90) involves a mole of inorganic phosphate:

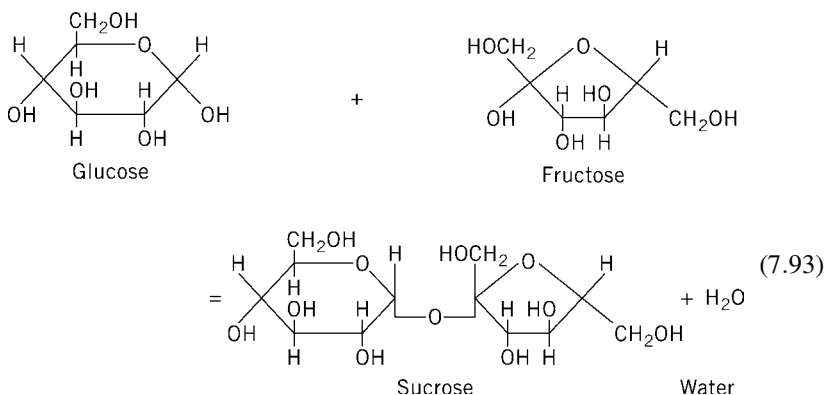


The 1,3-diphosphoglycerate that is formed then reacts with adenosine diphosphate to form adenosine triphosphate and 3-phosphoglycerate:



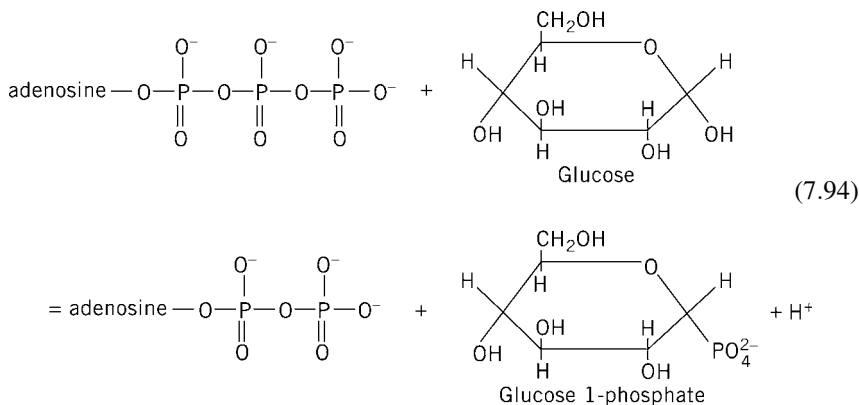
The net result of Equations (7.91) and (7.92) is the same as the sum of Equation (7.90), for which  $\Delta G_m^\circ = -29,300 \text{ J mol}^{-1}$ , and the formation of ATP from ADP, the reverse of Equation (7.90) for which  $\Delta G_m^\circ = +29,300 \text{ J mol}^{-1}$ . Thus, the value of  $\Delta G_m^\circ$  for the overall reaction is 0, which means that reactants and products exist at comparable concentrations, with ATP available to drive other reactions.

One such reaction that uses ATP as the source of the driving potential is the synthesis of sucrose from glucose and fructose:

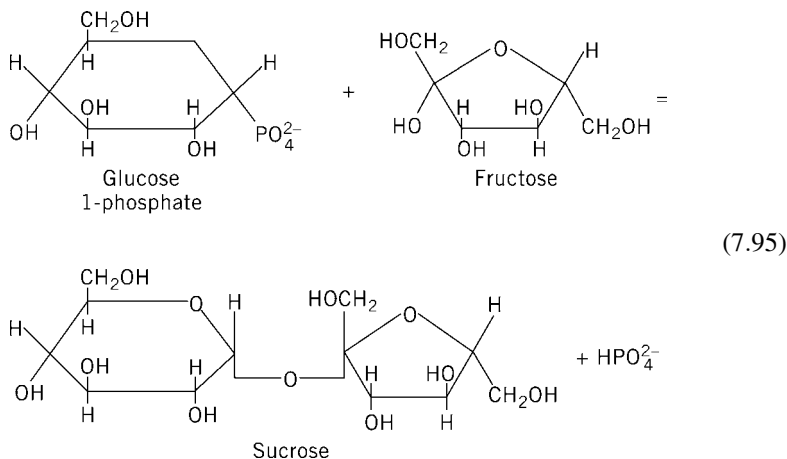




for which  $\Delta G_m^\circ = 23,000 \text{ J mol}^{-1}$ . The first step in this reaction in the cell is that of ATP with glucose to form glucose 1-phosphate:



Following the reaction in Equation (7.94), the glucose 1-phosphate reacts with fructose to form sucrose:



The sum of Equations (7.94) and (7.95) is the same as the sum of Equation (7.93) and Equation (7.89) so the net standard change in the Gibbs function is

$$\begin{aligned}
 \Delta G_m^\circ &= 23,000 \text{ J mol}^{-1} - 29,300 \text{ J mol}^{-1} \\
 &= -6,300 \text{ J mol}^{-1}
 \end{aligned}$$

Thus, the sum of the two reactions is spontaneous when reactants and products are in their standard states.

**Mechanical Work.** All cells exhibit motile and contractile properties. The remarkable thing about these activities of cells is that they are based on the direct coupling of chemical to mechanical action, in contrast to the heat engines that we have developed to perform our work for us. The mechanisms by which this coupling of chemical to mechanical processes takes place is not well understood, but the hydrolysis of adenosine triphosphate is known to be an important part of the molecular pathway. Although thermodynamic studies cannot provide information about the molecular steps involved, any mechanism that is proposed must be consistent with thermodynamic data [4].

**Osmotic Work.** It is characteristic of living cells that they maintain nonequilibrium values of the concentrations of certain solutes on opposite sides of membranes, particularly ions such as  $\text{Na}^+$  and  $\text{K}^+$ . It is this nonequilibrium distribution of ions that probably is responsible for the electrical potentials developed by living organisms. Again, although thermodynamic data do not lead to deductions about molecular mechanisms, they provide limiting values with which any mechanism must be consistent. We shall discuss the thermodynamic aspects of osmotic work in detail when we have developed the methods required to deal with solutions.

## EXERCISES

7.1. Prove the validity of Equations (7.39) and (7.60).

7.2. Derive the following expressions:

- a. This expression is useful because it suggests an independent variable that frequently leads to a linear plot for  $\Delta Y$  or  $\Delta G/T$ .

$$\left( \frac{\partial \Delta Y}{\partial (1/T)} \right)_P = - \left[ \frac{\partial (\Delta G/T)}{\partial (1/T)} \right]_P = -\Delta H \quad (7.96)$$

- b. Although  $T$  and  $P$  are the natural independent variables for  $G$ , it is sometimes useful to express  $G$  as a function of  $T$  and  $V$ . Derive the total differential of  $G$  as a function of  $T$  and  $V$ .

$$dG = V \left( \frac{\partial P}{\partial V} \right)_T dV + \left[ V \left( \frac{\partial P}{\partial T} \right)_V - S \right] dT \quad (7.97)$$

7.3. Derive the total differential for the Massieu function  $J$ , with natural variables  $T$  and  $V$ ; determine  $(\partial J/\partial T)_V$  and  $(\partial J/\partial V)_T$ ; and show that

$$\left( \frac{\partial U}{\partial V} \right)_T = -P + T \left( \frac{\partial P}{\partial T} \right)_V \quad (7.98)$$

7.4. If a rubber band is stretched, the reversible work is given by

$$DW = \tau dL$$

in which  $\tau$  is the tension on the band and  $L$  is its length.

a. If the stretching is carried out at constant pressure, show that

$$dG = \tau dL - SdT$$

b. Show also that

$$\left(\frac{\partial G}{\partial L}\right)_T = \tau$$

c. Prove that

$$\left(\frac{\partial \tau}{\partial T}\right)_L = -\left(\frac{\partial S}{\partial L}\right)_T$$

d. Assuming that the volume of the rubber band does not change during stretching, derive the following equation from fundamental thermodynamic principles:

$$\left(\frac{\partial U}{\partial L}\right)_T = \tau + T\left(\frac{\partial S}{\partial L}\right)_T = \tau - T\left(\frac{\partial \tau}{\partial T}\right)_L$$

e. For an ideal gas, it can be shown that

$$\frac{1}{P}\left(\frac{\partial P}{\partial T}\right)_V = \frac{1}{T}$$

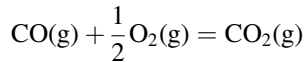
Show that the corresponding equation for an “ideal” rubber band is

$$\frac{1}{\tau}\left(\frac{\partial \tau}{\partial T}\right)_L = \frac{1}{T}$$

7.5. One mole of an ideal gas at 273.15 K is allowed to expand isothermally from 10.0 MPa to 1 MPa.

- a. Calculate (and arrange in tabular form) the values of  $W$ ,  $Q$ ,  $\Delta U_m$ ,  $\Delta H_m$ ,  $\Delta S_m$ ,  $\Delta G_m$ , and  $\Delta A_m$  of the gas if the expansion is reversible.
- b. Calculate (and arrange in tabular form adjacent to the preceding table) the values of  $W$ ,  $Q$ ,  $\Delta U_m$ ,  $\Delta H_m$ ,  $\Delta G_m$ , and  $\Delta A_m$  of the entire isolated system (gas plus its environment) if the expansion is reversible.

- c. Calculate (and arrange in tabular form adjacent to the preceding tables) the values of the same thermodynamic quantities in (a) for the gas if it is allowed to expand freely so that no work whatever is performed by it.
- d. Calculate (and arrange in tabular form adjacent to the preceding tables) the values of the same thermodynamic quantities in (b) for the entire isolated system if the expansion is free.
- 7.6. A mole of steam is condensed reversibly to liquid water at 100°C and 101.325-kPa (constant) pressure. The heat of vaporization of water is 2256.8 J g<sup>-1</sup>. Assuming that steam behaves as an ideal gas, calculate  $W$ ,  $Q$ ,  $\Delta U_m$ ,  $\Delta H_m$ ,  $\Delta S_m$ ,  $\Delta G_m$ , and  $\Delta A_m$  for the condensation process.
- 7.7. Using thermal data available in this and preceding chapters, derive an expression for  $\Delta G_m^\circ$  as a function of temperature for the reaction



- 7.8. If the heat capacities of reactants and products are expressed by equations of the form

$$C_{Pm} = a + bT + \frac{c'}{T^2}$$

in which  $a$ ,  $b$ , and  $c'$  are constants, what will be the form of the equation for  $\Delta G_m$  as a function of temperature?

- 7.9. Dickson et al. [5], calculated the Gibbs function for the ionization of the bisulfate ion by measurement of cell potentials in the temperature range from 50° to 250°C. They found that the Gibbs function could be represented by the equation

$$\begin{aligned} \Delta G^\circ = & -10772.95 T + 254118.2 + 1952.635 T \ln T - 4.743192 T^2 \\ & + 2.138535 \times 10^{-3} T^3 \end{aligned}$$

- a. What does the form of the temperature dependence imply about the temperature dependence of  $\Delta C_p$ ?
- b. Derive expressions for  $\Delta Y_m^\circ$ ,  $\Delta H_m^\circ$ ,  $\Delta S_m^\circ$ , and  $\Delta C_{Pm}^\circ$  as a function of temperature, and calculate values at 50°C and 200°C.
- 7.10. In theories of electrolytes, it is customary to regard the Gibbs function of the solution as composed of two parts:  $G_u$ , the Gibbs function of the uncharged particles, and  $G_e$ , the addition to the Gibbs function resulting from charging

the particles to form ions.  $G_e$  can be given by the equation

$$G_e = - \frac{2\pi^{1/2} N_1^{3/2} \epsilon^3 V (v_+ Z_+^2 + v_- Z_-^2)^{3/2}}{3D^{3/2} (kT)^{1/2}} \quad (7.99)$$

in which

$N_1$  = number of molecules per unit volume of solution

$\epsilon$  = charge on electron

$V$  = volume of solution

$v_+$  = number of positive ions per molecule

$Z_+$  = number of charges on each positive ion

$v_-$  = number of negative ions per molecule

$Z_-$  = number of charges on each negative ion

$D$  = dielectric constant of solution

$k$  = Boltzmann constant

$T$  = absolute temperature

- a. Assume that  $V$  and  $D$  do not change with temperature. Show that

$$H_e = \frac{3}{2} G_e$$

and that

$$S_e = \frac{G_e}{2T}$$

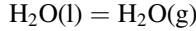
- b. It is obvious from Equation (7.99) that  $G_e$  is a negative quantity. Hence,  $S_e$  must be negative. What does this mean about the number of possible arrangements in a solution of ions as compared with the number in an equivalent solution of uncharged particles? How would you interpret this difference in terms of the molecular structure of the solution?

**7.11.** A spring obeys Hooke's law,  $\tau = -Kx$ , in which  $\tau$  is the tension and  $x$  is the displacement from the equilibrium position. For a particular spring at  $25^\circ\text{C}$ ,  $K = 2.0 \times 10^{-6} \text{ N m}^{-1}$  and  $dK/dT = -1.0 \times 10^{-8} \text{ N m}^{-1} \text{ K}^{-1}$ .

- a. The spring is placed in a thermostat at  $25^\circ\text{C}$  and stretched in a reversible manner from  $x = 0 \text{ m}$  to  $x = 0.010 \text{ m}$ . How much heat is given to or absorbed from the thermostat by the spring?

- b. The spring then is allowed to snap back to its original position without performing any work. How much heat would it deliver into the thermostat?

7.12. Consider as an example the equilibrium



at some fixed temperature. Let  $n$  represent the number of moles of  $\text{H}_2\text{O}(\text{g})$ , and let  $G$  and  $V$  represent the total Gibbs function and the total volume of all the substances involved. Equilibrium exists if

$$\left(\frac{\partial G}{\partial n}\right)_P = 0$$

- a. Show that

$$\left(\frac{\partial G}{\partial n}\right)_V = \left(\frac{\partial G}{\partial n}\right)_P + \left(\frac{\partial G}{\partial P}\right)_n \left(\frac{\partial P}{\partial n}\right)_V$$

- b. Prove then that

$$\left(\frac{\partial A}{\partial n}\right)_{V,T} = \left(\frac{\partial G}{\partial n}\right)_{P,T}$$

7.13. For stretching a film of water at constant pressure and temperature until its area is increased by  $1 \text{ m}^2$ , the change in the Gibbs function  $\Delta G$  is given by the equation

$$\Delta G = 7.564 \times 10^{-6} \text{ J} - (1.4 \times 10^{-8} \text{ J K}^{-1})t$$

in which  $t$  is the temperature in degrees Celsius at which the stretching is carried out. When the film is stretched, the total volume of the water is not changed measurably.

- How much work must be performed to increase the area of the film reversibly by  $1 \text{ m}^2$  at  $10^\circ\text{C}$ ?
- How much heat will be absorbed in the process in (a)?
- Calculate  $\Delta U$ ,  $\Delta H$ ,  $\Delta S$ , and  $\Delta A$  for (a).
- After the film has been stretched  $1 \text{ m}^2$  reversibly, it is allowed to contract spontaneously and irreversibly to its original area. No work is regained in this process. What is  $\Delta G$  for this step?
- Calculate  $Q$ ,  $\Delta U$ ,  $\Delta H$ ,  $\Delta S$ , and  $\Delta A$  for the process in (d).

- 7.14.** An electrochemical cell is placed in a thermostated bath at 25°C and 101.325 kPa, under which conditions it produces an emf of 0.100 V. For this cell,  $\partial\mathcal{E}/\partial T$  is  $1 \times 10^{-4} \text{ V K}^{-1}$ .
- If electrical work is performed on this cell and it is charged reversibly until 1 faraday of charge has been passed through it, how much heat is given to or absorbed from the thermostat?
  - If the charged cell is short-circuited, so that no electrical work is obtained from it, and it is allowed to return to its initial state in (a), how much heat is given to or absorbed from the thermostat?
- 7.15.** In the synthesis of sucrose, 23,000 J of the 29,300 J available from the hydrolysis of ATP are used for synthetic work. If we call 23,000/29,300 the efficiency of this pair of reactions carried out at 37°C, and if we consider 37°C equivalent to the temperature of the high-temperature reservoir of a heat engine, what would the temperature of the low-temperature reservoir have to be to attain a comparable efficiency for a reversible Carnot engine?
- 7.16.** Hawley [6] has measured the change in the Gibbs function for the transition from native to denatured chymotrypsinogen as a function of temperature and pressure. The reaction can be described as

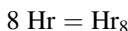
$$N(\text{native}) = D(\text{denatured})$$

The following values were found for the given thermodynamic functions at 0°C and 101.325 kPa:

$$\begin{aligned}\Delta G_m^\circ &= 10,600 \text{ J mol}^{-1} \\ \Delta S_m^\circ &= -950 \text{ J mol}^{-1} \text{ K}^{-1} \\ \Delta V_m^\circ &= -14.3 \times 10^{-6} \text{ m}^3 \text{ mol}^{-1} \\ (\partial\Delta V_m^\circ/\partial T)_P &= 1.32 \times 10^{-6} \text{ m}^3 \text{ mol}^{-1} \text{ K}^{-1} \\ (\partial\Delta V_m^\circ/\partial P)_T &= -0.296 \times 10^{-12} \text{ m}^6 \text{ J}^{-1} \text{ mol}^{-1} \\ \Delta C_{Pm} &= 16,000 \text{ J mol}^{-1} \text{ K}^{-1}\end{aligned}$$

Calculate the value of  $\Delta G_m$  at 35°C and 300 MPa assuming that  $\Delta C_{Pm}$ ,  $(\partial\Delta V_m/\partial T)_P$ , and  $(\partial\Delta V_m/\partial P)_T$  remain constant over that range of temperature and pressure.

- 7.17.** The oxygen-binding protein hemerythrin exists as an octamer in equilibrium with its monomers:



At pH 7.0 and 25°C, Langerman and Klotz [7] found  $\Delta G_m^\circ = -24.3 \text{ kJ mol}^{-1}$  (monomer). Langerman and Sturtevant [8] found  $\Delta H_m = 4 \pm 2 \text{ kJ mol}^{-1}$  (monomer). Calculate  $\Delta S_m$  for the formation of one mole of the octamer.

- What are the values of  $\Delta Y_m^\circ$  and  $\Delta G_m^\circ$  at 25°C?
- Derive an equation for  $\Delta H_m^\circ$  as a function of the temperature.
- Calculate the value of  $\Delta H_m^\circ$  at 25°C.
- What is the value of  $\Delta S_m^\circ$  at 25°C?
- Calculate  $\Delta C_{Pm}^\circ$  at 25°C for the reaction.
- What does the form of the function for the ionization constant as a function of temperature imply about the temperature dependence of  $\Delta C_P$ ?
- Derive expressions for  $\Delta Y_m^\circ$ ,  $\Delta G_m^\circ$ ,  $\Delta H_m^\circ$ ,  $\Delta S_m^\circ$ , and  $\Delta C_{Pm}^\circ$  as a function of temperature, and calculate values at 50°C and 200°C.

**7.18.** Derive the equation

$$\mu_{JT} = \frac{1}{C_P} \left[ T \left( \frac{\partial V}{\partial T} \right)_P - V \right] \quad (7.100)$$

Hint: Remember Equation (5.70), and use the total differential for  $\Delta Y$ .

## REFERENCES

- M. F. Massieu, *Comptes Rendus* **69**, 858 (1869).
- J. Willard Gibbs, *Trans. Conn. Acad. Sci.* 108–248, 343–524 (1878); *Collected Works*, Yale University Press, New Haven, 1928, p. 87.
- M. Planck, *Treatise on Thermodynamics*, Dover Publications, New York, L. E. Strong and H. F. Halliwell, *J. Chem. Educ.* **47**, 347 (1970).
- R. S. Edelstein and E. Eisenberg, *Ann. Rev. of Biochemistry* **49**, 921–956 (1980); M. F. Morales, in H. Sugi and G. H. Pollack, Eds., *Molecular Mechanisms of Muscle Contraction*, Plenum Press New York, 1986, pp. 331–342.
- A. G. Dickinson, D. J. Wesolowski, D. A. Palmer, and R. E. Mesmer, *J. Phys. Chem.* **94**, 7978 (1990).
- S. A. Hawley, *Biochemistry* **10**, 2436 (1971).
- N. Langerman and I. M. Klotz, *Biochemistry* **8**, 4746 (1969).
- N. Langerman and J. Sturtevant, *Biochemistry* **10**, 2809 (1971).





## CHAPTER 8

---

# APPLICATION OF THE GIBBS FUNCTION AND THE PLANCK FUNCTION TO SOME PHASE CHANGES

---

Now that we have developed convenient criteria for equilibrium and for spontaneity we can apply the laws of thermodynamics to problems of interest. In this chapter, we will deal with changes of phase in one-component systems, which are transformations of concern to the chemist and of particular concern to the geologist and the materials scientist.

### 8.1 TWO PHASES AT EQUILIBRIUM AS A FUNCTION OF PRESSURE AND TEMPERATURE

The equations that describe equilibrium conditions between two phases of the same substance are derivable from the two laws of thermodynamics with the aid of the functions that we defined in the preceding chapter. Let us represent the equilibrium in a closed system at any given temperature and pressure by the equation

$$\text{Phase A} = \text{Phase B} \quad (8.1)$$

As the system is at equilibrium at constant temperature and pressure, any infinitesimal transfer of matter between Phase A and Phase B occurs with a change of zero in

the Gibbs function and in the Planck function. That is,

$$\begin{aligned}dG &= G_{mA}dn_A + G_{mB}dn_B = 0 \\dY &= Y_{mA}dn_A + Y_{mB}dn_B = 0\end{aligned}\tag{8.2}$$

in which  $G_{mA}$  and  $G_{mB}$  are the molar Gibbs functions of A and B,  $Y_{mA}$  and  $Y_{mB}$  are the respective Planck functions, and  $dn_A$  and  $dn_B$  are the infinitesimal changes in the number of moles of A and B. As the system is closed,  $dn_B = -dn_A$  and

$$\begin{aligned}(G_{mA} - G_{mB})dn_A &= 0 \\(Y_{mA} - Y_{mB})dn_A &= 0\end{aligned}\tag{8.3}$$

As Equation (8.3) holds for any infinitesimal transfer  $dn_A$  whatsoever, the quantities in parentheses must equal zero and

$$\begin{aligned}G_{mA} &= G_{mB} \\Y_{mA} &= Y_{mB}\end{aligned}\tag{8.4}$$

If the temperature and pressure are changed by amounts  $dT$  and  $dP$  such that the system reaches a new state of equilibrium, then the molar Gibbs functions of A and B change by amounts of  $dG_A$  and  $dG_B$  such that

$$G_{mA} + dG_{mA} = G_{mB} + dG_{mB}$$

or

$$dG_{mA} = dG_{mB}\tag{8.5}$$

Similarly,

$$dY_{mA} = dY_{mB}\tag{8.6}$$

### Clapeyron Equation

If we apply Equation (7.38) for the total differential of  $G$  to the quantities in Equation (8.5), the result is

$$dG_{mA} = V_{mA}dP - S_{mA}dT\tag{8.7}$$

and

$$dG_{mB} = V_{mB}dP - S_{mB}dT\tag{8.8}$$

in which  $V_{mA}$  and  $V_{mB}$  are the molar volumes of A and B and  $S_{mA}$  and  $S_{mB}$  are the molar entropies. If we substitute from Equations (8.7) and (8.8) into Equation (8.5),

we obtain

$$V_{mB}dP - S_{mB}dT = V_{mA}dP - S_{mA}dT$$

which can be rearranged to give

$$(V_{mB} - V_{mA})dP = (S_{mB} - S_{mA})dT$$

Consequently

$$\frac{dP}{dT} = \frac{S_{mB} - S_{mA}}{V_{mB} - V_{mA}} = \frac{\Delta S_m}{\Delta V_m} \tag{8.9}$$

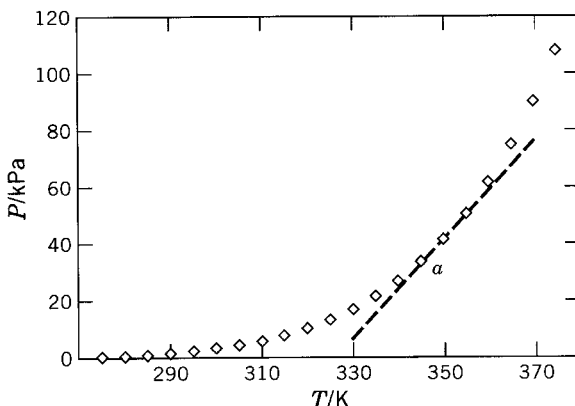
From Equation (8.9), we conclude that  $T$  and  $P$  are functions of each other at equilibrium. Once a value of  $T$  or  $P$  is chosen, the value of the other is fixed by Equation (8.9) and its integrated form. Such a relationship is illustrated by Figure 8.1 for water and water vapor.

We are interested in the value of the derivative  $dP/dT$  at a specified temperature and pressure such as is indicated by point  $a$  in Figure 8.1. For an isothermal, reversible (that is, equilibrium) condition at constant pressure, from Equation (7.26),

$$\Delta G = \Delta H - T\Delta S = 0$$

and

$$\Delta S = \frac{\Delta H}{T}$$



**Figure 8.1.** Equilibrium vapor pressure of water. The broken line is the tangent at 350 K. Data reprinted from the NIST Webbook, <http://webbook.nist.gov>.

Therefore, Equation (8.9) can be converted to

$$\frac{dP}{dT} = \frac{\Delta H_m}{T\Delta V_m} \quad (8.10)$$

which is generally known as the *Clapeyron equation*.

So far we have made no special assumptions as to the nature of the Phases A and B in deriving Equation (8.10). Evidently the Clapeyron equation is applicable to equilibrium between any two phases of one component at the same temperature and pressure, and it describes the functional relationship between the equilibrium pressure and the equilibrium temperature.

### Clausius–Clapeyron Equation

The Clapeyron equation can be reduced to a particularly convenient form when the equilibrium between A and B is that of a gas (g) and a condensed (cond) phase [liquid or solid]. In this situation

$$V_{mB} - V_{mA} = V_{m,g} - V_{m,cond}$$

Generally, the molar volume of a gas,  $V_{m,g}$  is much larger than the molar volume of the condensed phase  $V_{m,cond}$ ; that is,

$$V_{m,g} \gg V_{m,cond}$$

For example, the molar volume of liquid  $H_2O$  near the boiling point is about  $18 \text{ cm}^3$ , whereas that for water vapor is near  $30,000 \text{ cm}^3$ .

If  $V_{m,cond}$  is neglected with respect to  $V_{m,g}$  in Equation (8.10) (with the condensed phase as Phase A), the result is

$$\frac{dP}{dT} = \frac{\Delta H_m}{TV_{m,g}} \quad (8.11)$$

Furthermore, if we assume that the gas behaves ideally, then

$$\frac{dP}{dT} = \frac{\Delta H_m}{T(RT/P)} = \frac{P(\Delta H_m)}{RT^2}$$

or

$$\frac{1}{P} \frac{dP}{dT} = \frac{d \ln P}{dT} = \frac{\Delta H_m}{RT^2} \quad (8.12)$$

We can also write Equation (8.12) as

$$\begin{aligned} d \ln P &= \frac{\Delta H_m dT}{R T^2} \\ &= -\frac{\Delta H_m}{R} d\left(\frac{1}{T}\right) \end{aligned} \quad (8.13)$$

so that the slope of a plot of  $\ln P$  against  $1/T$  is  $-\Delta H_m/R$ . For many substances in a moderate temperature range, the heat of vaporization is substantially constant. Then, Equation (8.13) can be integrated as follows:

$$\ln \left(\frac{P_2}{P_1}\right) = -\frac{\Delta H_m}{R} \left(\frac{1}{T_2} - \frac{1}{T_1}\right) \quad (8.14)$$

or, written as the indefinite integral,

$$\ln P = -\frac{\Delta H_m}{RT} + \text{constant} \quad (8.15)$$

or

$$P = (\text{constant}) \exp(-\Delta H_m/RT) \quad (8.16)$$

Any one of Equations (8.14), (8.15), or (8.16) is known as the *Clausius–Clapeyron equation* and can be used either to obtain  $\Delta H$  from known values of the vapor pressure as a function of temperature or to predict vapor pressures of a liquid (or a solid) when the heat of vaporization (or sublimation) and one vapor pressure are known. The same equations also represent the variation in the boiling point of a liquid with changing pressure.

If we do not limit ourselves to the assumption of gas ideality, we can substitute for  $V_{m,g}$  from the text above Equation (5.55) into Equation (8.11), so that

$$\frac{dP}{dT} = \frac{\Delta H_m}{T(ZRT/P)}$$

or

$$\frac{1}{P} \frac{dP}{dT} = \frac{d \ln P}{dT} = \frac{\Delta H_m}{ZR} \frac{1}{T^2}$$

Rearranging, we have

$$d \ln P = \frac{\Delta H_m dT}{ZR T^2} = -\frac{\Delta H_m}{ZR} d\left(\frac{1}{T}\right)$$

or

$$\frac{d \ln P}{d(1/T)} = -\frac{\Delta H_m}{ZR} \quad (8.17)$$

Thus, the slope of a plot of  $\ln P$  against  $1/T$  is  $-\Delta H_m/ZR$ , and numerical differentiation (Appendix A) of experimental vapor-pressure data will provide values of  $\Delta H_m/Z$  as a function of temperature and pressure. If  $Z$  is known,  $\Delta H_m$  can be calculated.

The Antoine equation is the most commonly used empirical equation for describing the vapor pressure of a liquid as a function of temperature.

$$\ln P = A - \frac{B}{T + C}$$

where  $A$ ,  $B$ , and  $C$  are empirical constants for a particular gas and  $T$  is the thermodynamic temperature. Values of the constants for many gases and the temperature ranges over which they apply can be found in Ref. 1.

## 8.2 THE EFFECT OF AN INERT GAS ON VAPOR PRESSURE

Liquid–vapor equilibria commonly are observed when the system is exposed to the atmosphere (as in Fig. 8.2) rather than only to the vapor itself. Therefore, it is useful to derive the equations that are applicable to such a situation. We will assume that air is essentially insoluble in the liquid phase and that atmospheric pressure is represented by  $P$ . The saturation vapor pressure of the liquid in the absence of any foreign gas such as air can be shown to differ from that of the partial pressure of the vapor  $p$  in the presence of air.

As the liquid and vapor are in equilibrium at a given temperature and total pressure  $P$ , we can write

$$G_{m,g} = G_{m,l} \quad (8.18)$$

Let us assume that the vapor behaves as an ideal gas, even in the presence of the foreign gas. From Equation (7.43), we see that for one mole of an ideal gas at constant  $T$

$$dG_{m,g} = V_m dP = \frac{RT}{P} dp \quad (8.19)$$

Integration of this equation from the vapor pressure of the liquid  $p$  to the standard state for an ideal gas, a pressure of 0.1 MPa,  $P^\circ$ ,

$$\int_{G_{m,g}}^{G_{m,g}^\circ} dG_{m,g} = \int_p^{P^\circ} RT d \ln P$$

which gives

$$RT \ln \frac{P}{P^\circ} = G_{m,l} - G_{m,g}^\circ \quad (8.20)$$

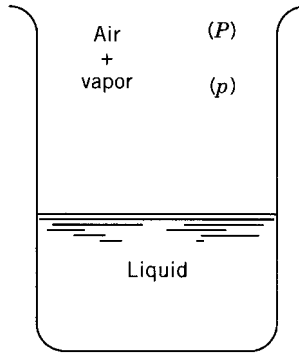


Figure 8.2. Liquid–vapor equilibrium in the presence of an inert gas.

### Variable Total Pressure at Constant Temperature

At constant temperature, Equation (8.20) can be differentiated with respect to the total pressure to give

$$RT \left( \frac{\partial \ln p}{\partial P} \right)_T - RT \left( \frac{\partial \ln P^\circ}{\partial P} \right)_T = \left( \frac{\partial G_{m,l}}{\partial P} \right)_T - \left( \frac{\partial G_{m,g}^\circ}{\partial P} \right)_T \quad (8.21)$$

The quantity  $G_{m,g}^\circ$  is defined at a fixed standard pressure, so it is not a function of the ambient pressure. Thus, the second term on the right side of Equation (8.21) is equal to zero. Similarly, the second term on the left is also equal to zero. From Equation (7.43),  $(\partial G_m / \partial P)_T$  is equal to  $V_m$ . Thus, Equation (8.21) reduces to

$$\left( \frac{\partial \ln p}{\partial P} \right)_T = \frac{V_{m,l}}{RT} \quad (8.22)$$

in which  $V_{m,l}$  is the molar volume of the liquid phase.

The change of vapor pressure with change in total pressure of an inert atmosphere is small. For example, for water, where  $V_{m,l}$  is  $18 \text{ cm}^3$ , the right side of Equation (8.22) reduces to less than 0.001 per bar at room temperature (for  $R = 8.31 \text{ J mol}^{-1} \text{ K}^{-1}$  and  $T = 298 \text{ K}$ ).

Equation (8.22) can be integrated between  $p_0$ , the vapor pressure in the absence of inert gas, to  $P$ , the pressure of inert gas, to obtain

$$\ln \frac{p}{p_0} = \frac{V_{m,l}(P - p_0)}{RT} \quad (8.23)$$

where  $p$  is the vapor pressure in the presence of inert gas. If  $p_0$  is small compared with  $P$ , and we recognize that  $V_{m,g}$  is equal to  $RT/P$ , then we can write

$$\ln \frac{p}{p_0} = \frac{V_{m,l}}{V_{m,g}} \quad (8.24)$$



This form of the relationship makes obvious the small effect of an inert gas on vapor pressure, because  $V_{m,g}$  is much larger than  $V_{m,l}$ .

### Variable Temperature at Constant Total Pressure

At constant total pressure, Equation (8.20) can be differentiated with respect to  $T$  to give the temperature dependence of the vapor pressure of a liquid in equilibrium with its vapor in the presence of air at a fixed atmosphere pressure:

$$RT \left( \frac{\partial \ln p}{\partial T} \right)_P = \left( \frac{\partial G_{m,l}}{\partial T} \right)_P - \left( \frac{\partial G_{m,g}^\circ}{\partial T} \right)_P \quad (8.25)$$

From Equation (7.44), we can substitute for each term on the right side of Equation (8.25) to obtain

$$RT \left( \frac{\partial \ln p}{\partial T} \right)_P = -S_{m,l} + S_{m,g}^\circ = \Delta S_{m,v} \quad (8.26)$$

As the system is at equilibrium at constant temperature and pressure,

$$\Delta G_{m,v} = 0$$

and

$$\Delta S_{m,v} = \frac{\Delta H_{m,v}}{T}$$

so that

$$\left( \frac{\partial \ln p}{\partial T} \right)_P = \frac{\Delta H_{m,v}}{RT^2} \quad (8.27)$$

which is a result comparable with Equation (8.12).

### 8.3 TEMPERATURE DEPENDENCE OF ENTHALPY OF PHASE TRANSITION

We are accustomed to think of the temperature coefficient of  $\Delta H_m$  as given from Equation (4.55) by the expression

$$\left( \frac{\partial \Delta H_m}{\partial T} \right)_P = \Delta C_{Pm} \quad (8.28)$$

However, in any phase transition, the equilibrium pressure does not remain constant as the temperature is varied. Hence, to obtain  $(d\Delta H_m/dT)_{\text{equil}}$ , the temperature coefficient of the heat of vaporization, we must find the dependence of  $\Delta H_m$  on pressure as

well as on temperature. Thereafter, as pressure is also a function of the temperature, we can obtain  $(d\Delta H_m/dT)_{\text{equil}}$ .

Let us start with an equation for the total differential:

$$\begin{aligned} d(\Delta H_m) &= \left(\frac{\partial \Delta H_m}{\partial T}\right)_P dT + \left(\frac{\partial \Delta H_m}{\partial P}\right)_T dP \\ &= \Delta C_{Pm} dT + \left(\frac{\partial H_{mB}}{\partial P} - \frac{\partial H_{mA}}{\partial P}\right)_T dP \end{aligned} \quad (8.29)$$

in which  $H_{mB}$  and  $H_{mA}$  are the molar enthalpies of Phase B and Phase A. It can be shown from properties of the Planck function [Equation (7.61)] that

$$\left(\frac{\partial H_m}{\partial P}\right)_T = V - T\left(\frac{\partial V_m}{\partial T}\right)_P$$

With this relationship, Equation (8.29) can be converted to

$$d(\Delta H_m) = \Delta C_{Pm} dT + \left[\Delta V_m - T\left(\frac{\partial \Delta V_m}{\partial T}\right)_P\right] dP$$

As  $dT$  and  $dP$  are not independent if equilibrium between phases is maintained, we can use the Clapeyron equation [Equation (8.10)] to substitute for  $dP$  and to obtain

$$d(\Delta H_m) = \Delta C_{Pm} dT + \left[\Delta V_m - T\left(\frac{\partial \Delta V_m}{\partial T}\right)_P\right] \frac{\Delta H_m}{T\Delta V_m} dT$$

From this equation, it follows that

$$\frac{d(\Delta H_m)}{dT} = \Delta C_{Pm} + \frac{\Delta H_m}{T} - \Delta H_m \left(\frac{\partial \ln \Delta V_m}{\partial T}\right)_P \quad (8.30)$$

So far in the derivation we have made no assumption as to the nature of Phases A or B; thus, Equation (8.30) is applicable to all types of phase transitions. When both A and B are condensed phases, the third term on the right side of Equation (8.30) is small compared with the others and the equation reduces to

$$\frac{d(\Delta H_m)}{dT} = \Delta C_{Pm} + \frac{\Delta H_m}{T} \quad (8.31)$$

If the phase transition is a vaporization or sublimation, and if the vapor can be assumed to be an ideal gas, an alternative approximation applies:

$$\Delta V_m \cong V_{m \text{ gas}} \cong \frac{RT}{P}$$

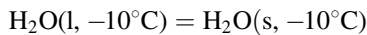
From this approximation, it follows that the third term of Equation (8.30) cancels the second and that

$$\frac{d(\Delta H_m)}{dT} \cong \Delta C_{Pm} \quad (8.32)$$

Although Equations (8.28) and (8.32) are formally alike, they refer to different types of processes. The former is strictly true for a process that occurs at a constant pressure throughout a temperature range. Vaporization or sublimation does not fulfill this restriction, but nevertheless, Equation (8.32) is approximately correct because the molar volume of the condensed phase is small compared with that of the gas, and the vapor pressure is small enough that the vapor behaves as an ideal gas.

#### 8.4 CALCULATION OF CHANGE IN THE GIBBS FUNCTION FOR SPONTANEOUS PHASE CHANGE

Thus far we have restricted our attention to phase changes in which equilibrium is maintained. It also is useful, however, to find procedures for calculating the change in the Gibbs function in transformations that are known to be spontaneous, for example, the freezing of supercooled water at  $-10^\circ\text{C}$ :



At  $0^\circ\text{C}$  and 101.325-kPa pressure, the process is at equilibrium. Hence

$$\Delta G_{m,0^\circ\text{C}} = 0$$

At  $-10^\circ\text{C}$ , the supercooled water can freeze spontaneously. Therefore,

$$\Delta G_{m,-10^\circ\text{C}} < 0$$

Now we wish to evaluate  $\Delta G_m$  numerically.

##### Arithmetic Method

The simplest procedure to calculate the change in the Gibbs function at  $-10^\circ\text{C}$  uses the relationship [Equation (7.26)] for one mole,

$$\Delta G_m = \Delta H_m - T\Delta S_m$$

for any isothermal process.  $\Delta H_m$  and  $\Delta S_m$  at  $-10^\circ\text{C}$  ( $T_2$ ) are calculated from the known values at  $0^\circ\text{C}$  ( $T_1$ ) and from the temperature coefficients of  $\Delta H_m$  and  $\Delta S_m$ . As the procedure can be represented by the sum of a series of equations, the method may be called an arithmetic one. The series of equations is given in Table 8.1. (Here, as in Chapter 4, Equations (4.83)–(4.86) we assume that  $C_P$  is constant for ice and supercooled water over this temperature range. See Ref. 18 in

**TABLE 8.1. Change in Gibbs Function for Freezing of Supercooled Water**

$\text{H}_2\text{O} (\text{l}, 0^\circ\text{C}) = \text{H}_2\text{O} (\text{s}, 0^\circ\text{C})$	$\Delta H_m = -6008 \text{ J mol}^{-1}$ $\Delta S_m = \frac{-6008}{273.15} = -21.995 \text{ J mol}^{-1} \text{ K}^{-1}$
$\text{H}_2\text{O} (\text{s}, 0^\circ\text{C}) = \text{H}_2\text{O} (\text{s}, -10^\circ\text{C})$	$\Delta H_m = \int_{T_1}^{T_2} C_{Pm,s} dT = C_{Pm,s}(T_2 - T_1)$ $= 36.4(-10) = -364 \text{ J mol}^{-1}$ $\Delta S_m = \int_{T_1}^{T_2} \frac{C_{Pm,s}}{T} dT$ $= C_{Pm,s} \ln \frac{T_2}{T_1} = -1.358 \text{ J mol}^{-1} \text{ K}^{-1}$
$\text{H}_2\text{O} (\text{l}, -10^\circ\text{C}) = \text{H}_2\text{O} (\text{l}, 0^\circ\text{C})$	$\Delta H_m = \int_{T_2}^{T_1} C_{Pm,l} dT$ $= 75(10) = 750 \text{ J mol}^{-1}$ $\Delta S_m = \int_{T_2}^{T_1} \frac{C_{Pm,l}}{T} dT = 2.797 \text{ J mol}^{-1} \text{ K}^{-1}$
$\text{H}_2\text{O} (\text{l}, -10^\circ\text{C}) = \text{H}_2\text{O} (\text{s}, -10^\circ\text{C})$	$\Delta H_m = -5622 \text{ J mol}^{-1}$ $\Delta S_m = -20.556 \text{ J mol}^{-1} \text{ K}^{-1}$

Chapter 4 for recent results on  $C_P$  for this system.) From the values calculated for  $\Delta H_m$  and  $\Delta S_m$ .

$$\Delta G_m = -5622 + (263.15)(20.556) = -213 \text{ J mol}^{-1}$$

and

$$\Delta Y_m = -\frac{\Delta G_m}{T} = \frac{213 \text{ J mol}^{-1}}{263.15 \text{ K}} = 0.809 \text{ J mol}^{-1} \text{ K}^{-1}$$

### Analytic Method

The proposed problem also could be solved by integrating Equation (7.57) for one mole,

$$\left(\frac{\partial \Delta Y_m}{\partial T}\right)_P = \frac{\Delta H_m}{T^2}$$

As in the arithmetic method, we can assume that the heat capacities of ice and water are substantially constant throughout the small temperature range under consideration. Thus, from Equation (8.28),

$$\left(\frac{\partial \Delta H_m}{\partial T}\right)_P = \Delta C_{Pm}$$

and during integration, we obtain

$$\begin{aligned}\Delta H_m &= \Delta H_{m0} + \int (C_{Pm,ice} - C_{Pm,water})dT \\ &= \Delta H_{m0} - 38.9T\end{aligned}\quad (8.33)$$

where  $\Delta H_{m0}$  is a constant of integration (not equal to  $\Delta H_m$  at  $0^\circ\text{C}$ ). As, at  $0^\circ\text{C}$ ,  $\Delta H_m$  is  $-6008 \text{ J mol}^{-1}$ , we can determine  $\Delta H_{m0}$ :

$$\Delta H_{m0} = -6008 + 38.9 (273.15) = 4617.54 \text{ J mol}^{-1}$$

(More significant figures are retained in these numbers than can be justified by the precision of the data on which they are based. However, such a procedure is necessary in calculations that involve small differences between large numbers.) Thus,

$$\Delta H_m = 4617.54 - 38.9T$$

and

$$\begin{aligned}\Delta Y_m &= \int \frac{(4617.54 - 38.9T)}{T^2} dT \\ &= \frac{4617.54}{T} - 38.9 \ln T + I\end{aligned}\quad (8.34)$$

in which  $I$  is a constant of integration. As  $\Delta Y_m$  is known to be zero at  $0^\circ\text{C}$ , the constant  $I$  can be evaluated:

$$I = \frac{4617.54}{273.15} + 38.9 \ln (273.15) = 235.135$$

and

$$\Delta Y_m = 235.135 - \frac{4617.54}{T} - 38.9 \ln T \quad (8.35)$$

Equation (8.35) leads to

$$\Delta G_m = 4617.54 + 38.9T \ln T - 235.135 T \quad (8.36)$$

At  $-10^\circ\text{C}$ , the value of the Gibbs function is

$$\Delta G_{m,-10^\circ\text{C}} = -213 \text{ J mol}^{-1}$$

This result is the same as that obtained by the arithmetic method.

As

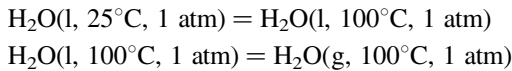
$$\begin{aligned}
 \Delta G &= \Delta H - T\Delta S \\
 &= Q_{\text{system}} - T\Delta S \\
 &= -Q_{\text{surroundings}} - T\Delta S \\
 &= -T\Delta S_{\text{surroundings}} - T\Delta S_{\text{system}} \qquad (8.37)
 \end{aligned}$$

we should note that a process like the freezing of supercooled water, which is spontaneous despite having a negative value of  $\Delta S_{\text{sys}}$ , can have a negative value of  $\Delta G$  only if the value of  $\Delta S_{\text{surr}}$  is positive and of greater magnitude than  $\Delta S_{\text{sys}}$ .

## EXERCISES

**8.1.** Examine each of the following seven transformations:

- $\text{H}_2\text{O}(\text{s}, -10^\circ\text{C}, P^\circ) = \text{H}_2\text{O}(\text{l}, -10^\circ\text{C}, P^\circ)$ . (*Note:* No specification is made that this process is carried out isothermally, isobarically, or reversibly.)
- Same as part (a) but restricted to a reversible change.
- Same as part (a) but restricted to isothermal and isobaric conditions.
- The two-step, isobaric, reversible transformation:



- Ideal gas ( $25^\circ\text{C}$ , 10 MPa) = ideal gas ( $25^\circ\text{C}$ , 100 kPa), reversible.
- Ideal gas ( $25^\circ\text{C}$ , 10 MPa) = ideal gas ( $25^\circ\text{C}$ , 1 MPa), no work performed.
- Adiabatic reversible expansion of an ideal gas from 10 MPa to 1 MPa.

Consider each of the following equations:

- $\int \frac{DQ_m}{T} = \Delta S_m$
- $Q_m = \Delta H_m$
- $\frac{\Delta H_m}{T} = \Delta S_m$
- $\Delta G_m = \text{actual net work}$
- $\Delta G_m = \text{maximum net work}$

For each transformation, list the equations of the group (a) to (e) that are valid. If your decision depends on the existence of conditions not specified, state what these conditions are.

- 8.2.** Calculate  $\Delta G_m^\circ$  and  $\Delta Y_m^\circ$  for each of the following transformations:
- $\text{H}_2\text{O}(l, 100^\circ\text{C}, 1 \text{ Bar}) = \text{H}_2\text{O}(g, 100^\circ\text{C}, 1 \text{ Bar})$ .
  - $\text{H}_2\text{O}(l, 25^\circ\text{C}, 1 \text{ Bar}) = \text{H}_2\text{O}(g, 25^\circ\text{C}, 1 \text{ Bar})$ . The vapor pressure of  $\text{H}_2\text{O}$  at  $25^\circ\text{C}$  is 3.17 kPa.
- 8.3.** The vapor pressure of pure bromine at  $25^\circ\text{C}$  is 28.4 kPa. The vapor pressure of bromine in dilute aqueous solution at  $25^\circ\text{C}$  obeys the equation  $p = 147 m_2$ , in which  $m_2$  is molality and  $p$  is expressed in kPa.
- Calculate  $\Delta G_m$  and  $\Delta Y_m$  for the transformation  
 $\text{Br}_2(l, 25^\circ\text{C}, 28.4 \text{ kPa}) = \text{Br}_2(m_2 = 0.01, \text{ aq. soln.}, 25^\circ\text{C}, P_{\text{eq}})$
  - What would be the molality of bromine in a saturated solution in water at  $25^\circ\text{C}$ ?
- 8.4.** An equation for  $\Delta G_m$  for the freezing of supercooled water can be obtained also by integrating the equation

$$\left(\frac{\partial \Delta G_m}{\partial T}\right)_p = -\Delta S_m$$

An expression for  $\Delta S_m$  as a function of temperature for substitution into the preceding equation can be derived from

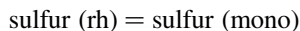
$$\left(\frac{\partial \Delta S_m}{\partial T}\right)_p = \frac{\Delta C_{Pm}}{T}$$

- On the assumption that  $\Delta C_{Pm}$  is a constant, show that

$$\Delta G_m = I' - \Delta C_{Pm}(T \ln T) + (\Delta C_{Pm} - \Delta S_{m0})T$$

in which  $I'$  and  $\Delta S_{m0}$  are constants of integrations.

- Evaluate the constants from data for the freezing process at  $0^\circ\text{C}$ .
  - Calculate  $\Delta G_m$  at  $-10^\circ\text{C}$ , and compare the result with the values calculated by the methods described in the text.
- 8.5.** The transition



where rh = rhombic and mono = monoclinic is at equilibrium at 101.325 kPa at  $95.5^\circ\text{C}$ . The entropies (in  $\text{J mol}^{-1} \text{K}^{-1}$ ) of the allotropic forms are the following functions of temperature:

$$S_{m,\text{rh}} = -61.13 + 14.98 \ln T + 26.11 \times 10^{-3}T$$

$$S_{m,\text{mono}} = -60.88 + 14.90 \ln T + 29.12 \times 10^{-3}T$$

Compute the change in the Gibbs function and the change in the Planck function for this allotropic transition at  $25^\circ\text{C}$ .

**TABLE 8.2. A List of Entropies and Densities of Carbon**

	Graphite	Diamond
$\Delta_f G_{m,298}^\circ / (\text{J mol}^{-1})$	0	2900
$S_{m,298}^\circ / (\text{J mol}^{-1} \text{K}^{-1})$	5.740	2.377
Density / ( $\text{g cm}^{-3}$ )	2.22	3.51

- 8.6.** By convention, the standard Gibbs function for formation  $\Delta_f G_{\text{m}}^\circ$  of graphite is assigned the value of zero. On this basis,  $\Delta_f G_{298}^\circ$  of diamond is  $2900 \text{ J mol}^{-1}$ . Entropies and densities also are listed in Table 8.2. Assuming that the entropies and densities are approximately constant, determine the conditions of temperature and pressure under which the manufacture of diamonds from graphite would be thermodynamically and kinetically practical [2].
- 8.7.** The melting points of carbon tetrachloride at various pressures are given in Table 8.3 together with  $\Delta V_{\text{m}}$  fusion. Calculate  $\Delta H_{\text{m}}$  and  $\Delta S_{\text{m}}$  of fusion at (a) 0.1 MPa and (b) 600 MPa.
- 8.8.** For liquid thiacyclobutane, the vapor pressure, in millimeters of mercury, can be expressed by the equation [3]

$$\log_{10} P = 7.01667 - \frac{1321.331}{t + 224.513}$$

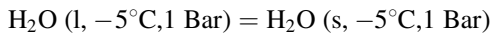
in which  $t$  is in  $^\circ\text{C}$ . Calculate  $\Delta H_{\text{m}}$  of vaporization at 298 K.

- 8.9.** The vapor pressure of liquid helium can be expressed by the equation

$$P = AT^{5/2} e^{-[(a/T)+bT^{5.5}]}$$

in which  $A$ ,  $a$ , and  $b$  are constants. Derive an equation for  $\Delta H_{\text{m}}$  of vaporization as a function of temperature.

- 8.10.** Compute  $\Delta G_{\text{m}}^\circ$  and  $\Delta Y_{\text{m}}^\circ$  for the transformation

**TABLE 8.3. Melting Points of Carbon Tetrachloride**

$P/\text{MPa}$	$t/^\circ\text{C}$	$\Delta V_{\text{m}}/(\text{cm}^3 \text{mol}^{-1})$
0.1	-22.6	3.97
101	15.3	3.06
203	48.9	2.51
507	130.8	1.52
709	176.2	1.08



given that the vapor pressure of supercooled liquid water at  $-5^{\circ}\text{C}$  is 421.7 Pa and that of ice is 401.6 Pa.

- 8.11.** What would be the form of the integrated Clausius–Clapeyron equation if the heat capacity of the vapor were given by the equation

$$C_{Pm} = a + bT$$

and that of the condensed phase by

$$C'_{Pm} = a' + b' T$$

in which the  $a$ 's and  $b$ 's are constants?

- 8.12.** Rhombic sulfur is the stable form at room temperature, and monoclinic sulfur is the metastable form. The transition temperature is  $95.5^{\circ}\text{C}$ . The melting point of monoclinic sulfur is  $120^{\circ}\text{C}$ . How would you evaluate a report that  $77^{\circ}\text{C}$  is the melting point of rhombic sulfur? Answer in terms of a diagram of Gibbs function versus temperature for this system.
- 8.13.** In the free-volume theory of liquids, the molar Helmholtz function  $A_m$  is defined by the equation

$$A_m = A_m^{\ddagger}(T) - RT \ln V_{mf} - \Lambda$$

in which  $A_m^{\ddagger}(T)$  is the volume-independent term of the Helmholtz function,  $V_{mf}$  is the molar free volume in the liquid, and  $\Lambda$  is the contribution to the potential energy from intermolecular forces. Assuming that

$$V_{mf} = V_m - b$$

and

$$\Lambda = \frac{a}{V_m}$$

in which  $V_m$  is the geometric volume and  $a$  and  $b$  are the van der Waals constants, prove that this liquid would obey the van der Waals equation of state.

- 8.14.** The data in Table 8.4 [4] represent the vapor pressure of mercury as a function of temperature. Plot  $\ln P$  as a function of  $1/T$  to a scale consistent with the precision of the data. If the resultant plot is linear, calculate  $\Delta H_m/z$  from the slope obtained by a least-squares fit to the line. If the plot is curved, use a numerical differentiation procedure to obtain the value of  $\Delta H_m/Z$  as a function of  $T$ , and calculate  $\Delta C_{Pm}$ . See Appendix A for methods.
- 8.15.** Da Silva and Monte [5] have measured the vapor pressure of crystalline benzoylacetone by the Knudsen mass-loss effusion method over the temperature range,  $292\text{--}302^{\circ}\text{C}$ . One set of their data is given in Table 8.5. As the vapor pressure is low, and the temperature range is small, use the

**TABLE 8.4. Vapor pressure of Mercury as a Function of Temperature**

$T/K$	$P/\text{kPa}$
400.371	0.139
417.129	0.293
426.240	0.424
432.318	0.538
439.330	0.706
441.757	0.774
447.720	0.964
451.420	1.101
454.160	1.213
456.359	1.309
462.673	1.627
469.222	2.024
474.605	2.414
479.080	2.784
485.190	3.369
491.896	4.128
497.570	4.882

**TABLE 8.5. Vapor Pressure of Benzoylacetone**

$T/K$	$p/\text{Pa}$
292.197	0.2958
293.194	0.3360
294.238	0.3780
295.198	0.4166
296.265	0.4858
297.165	0.5459
298.208	0.6209
299.165	0.7066
300.215	0.8169
301.224	0.9099
301.175	0.9921

Clausius–Clapeyron equation to calculate the value of  $\Delta H_{\text{m,sublimation}}$  for benzoyl-acetone.

- 8.16.** Use the NIST WEBBOOK (<http://webbook.nist.gov>) to find the vapor pressure of water as a function of temperature over the range from 300 K to 600 K. When you reach the home page for the WEBBOOK, click on the NIST Chemistry Webbook, click on “Name” under search options, type “water” in the space for name, click on “thermodynamic data,” click on “condensed phase,” click on “saturation properties,” and insert the temperature

range and increments of 20 K. You will then be presented with a table of the saturation properties of water, both liquid and vapor phases, including the equilibrium temperature and pressure, and the density, entropy, and enthalpy referred to a common reference state. Print the table landscape to obtain all the data. Enter the data into a spreadsheet of your choice.

- a. Plot the data as  $P$  against  $T$  and as  $\ln P$  against  $1/T$ . Fit the data to an equation with  $\ln P$  as a linear function of  $1/T$  and to the Antoine equation

$$\ln P = A + \frac{B}{C + T}$$

and use the residuals to decide which is the better fit.

- b. Use the best-fit equation to calculate  $dP/dT$  at each of the data points.  
 c. Use the information from the data sheet to calculate  $\Delta S/\Delta V$  at each data point, and compare the results with the values of  $dP/dT$ .  
 d. Use the values of  $dP/dT$  at each data point to calculate  $\Delta H/Z$  at each data point. You can calculate values of  $Z$  with the Redlich–Kwong equation at the data points and then obtain values of  $\Delta H_{\text{vap}}$  as a function of temperature.

## REFERENCES

1. B. E. Poling, J. M. Prausnitz, and J. P. O'Connell, *The Properties of Gases and Liquids*. 5th Ed., McGraw-Hill, New York, 2001, pp. 7.4, 7.7, A.47–A.60.
2. Reprinted with permission from F. P. Bundy, H. T. Hall, H. M. Strong, and R. H. Wentorf, Jr., *Nature* **176**, 51 (1955). Copyright 1955 Macmillan Magazines Limited.
3. D. W. Scott, H. L. Finke, W. N. Hubbard, J. P. McCullough, C. Katz, M. E. Gross, J. F. Messerly, R. E. Pennington, and G. Waddington, *J. Am. Chem. Soc.* **75**, 2795 (1953).
4. D. Ambrose and C. H. Sprake, *J. Chem. Thermodynamics* **4**, 603 (1972).
5. M. A. V. Ribeiro Da Silva and M. J. S. Monte, *J. Chem. Thermodynamics* **24**, 1219 (1992).

## CHAPTER 9

---

# THERMODYNAMICS OF SYSTEMS OF VARIABLE COMPOSITION

---

Many equations we have used thus far can be applied only to closed systems of constant composition. This limitation simply means that we have been dealing with a special case. In general, to fix the state of a system, the values of two independent variables and the mole numbers of the components must be fixed. It is these latter variables that we have been able to neglect because we have discussed only closed systems of fixed composition. Now we will extend our discussion to the more general systems and, in succeeding chapters, apply the equations developed.

### 9.1 STATE FUNCTIONS FOR SYSTEMS OF VARIABLE COMPOSITION

For a closed system of fixed composition, the extensive thermodynamic properties such as  $V$ ,  $U$ ,  $S$ ,  $A$ ,  $Y$ , and  $G$  are functions of any pair of convenient independent variables. For example, Equation (7.38) suggests that  $G$  is a natural function of  $T$  and  $P$ . That is  $G = f(T, P)$ . The total differential of  $G$  would be

$$\begin{aligned}dG &= \left(\frac{\partial G}{\partial T}\right)_P dT + \left(\frac{\partial G}{\partial P}\right)_T dP \\ &= -S(T, P)dT + V(T, P)dP\end{aligned}\tag{9.1}$$

When the composition of a system varies, the mole numbers of the components are additional independent variables and we have

$$G = f(T, P, n_1, n_2, \dots, n_i, \dots) \quad (9.2)$$

so that the total differential becomes

$$dG = \left(\frac{\partial G}{\partial T}\right)_{P, n_i} dT + \left(\frac{\partial G}{\partial P}\right)_{T, n_i} dP + \sum \left(\frac{\partial G}{\partial n_i}\right)_{T, P, n_j} dn_i \quad (9.3)$$

The partial derivative  $(\partial G/\partial n_i)_{T, P, n_j}$ , in which  $i \neq j$ , represents the rate of increase in the Gibbs function of the system per mole of component  $i$  added to the system when  $T$ ,  $P$ , and the other mole numbers are held constant. [Equation (9.3) is based on the assumption that surface effects can be neglected.] The summation is over all components of the system.

If the composition is constant, so the  $dn_i$  terms are zero, Equation (9.3) becomes Equation (9.1), and we can write

$$\left(\frac{\partial G}{\partial T}\right)_{P, n_i} = -S(T, P, n_i) \quad (9.4)$$

and

$$\left(\frac{\partial G}{\partial P}\right)_{T, n_i} = V(T, P, n_i) \quad (9.5)$$

Here we recognize explicitly that  $S$  and  $V$  also are functions of the mole numbers as well as functions of  $T$  and  $P$ .

The partial derivative of  $G$  with respect to the mole number  $n_i$  at constant  $T$  and  $P$  and mole numbers  $n_j \neq n_i$  is defined as

$$\left(\frac{\partial G}{\partial n_i}\right)_{T, P, n_j} = \mu_i \quad (9.6)$$

where  $\mu_i$  is the *chemical potential*. We can now rewrite Equation (9.3) in terms of the chemical potential as

$$dG = -SdT + VdP + \sum \mu_i dn_i \quad (9.7)$$

Because, from Equation (7.28),

$$A = G - PV \quad (9.8)$$

and

$$dA = dG - PdV - VdP$$

we can substitute from Equation (9.7) in Equation (9.8) to obtain

$$dA = -PdV - SdT + \sum \mu_i dn_i \quad (9.9)$$

so that the chemical potential is also

$$\mu_i = \left( \frac{\partial A}{\partial n_i} \right)_{T,V,n_j} \tag{9.10}$$

Similarly, we can show from previously used thermodynamic relationships that

$$\mu_i = \left( \frac{\partial U}{\partial n_i} \right)_{S,V,n_j} = \left( \frac{\partial H}{\partial n_i} \right)_{S,P,n_j} = -\frac{1}{T} \left( \frac{\partial S}{\partial n_i} \right)_{U,V,n_j} = -\frac{1}{T} \left( \frac{\partial Y}{\partial n_i} \right)_{T,P,n_j} \tag{9.11}$$

Because most chemical, biological, and geological processes occur at constant temperature and pressure, it is convenient to provide a special name for the partial derivatives of all thermodynamic properties with respect to mole number at constant pressure and temperature. They are called *partial molar properties*, and they are defined by the relationship

$$J_{mi} = \left( \frac{\partial J}{\partial n_i} \right)_{T,P,n_{j \neq i}} \tag{9.12}$$

where  $J$  is any thermodynamic property. The partial molar Gibbs function is the *chemical potential*; however, the following derivatives are partial molar properties, but they are not chemical potentials:

$$\left. \begin{aligned} \left( \frac{\partial A}{\partial n_i} \right)_{T,P,n_j} &= A_{mi} \neq \mu_i \\ \left( \frac{\partial H}{\partial n_i} \right)_{T,P,n_j} &= H_{mi} \neq \mu_i \\ \left( \frac{\partial U}{\partial n_i} \right)_{T,P,n_j} &= U_{mi} \neq \mu_i \\ \left( \frac{\partial S}{\partial n_i} \right)_{T,P,n_j} &= S_{mi} \neq -\frac{\mu_i}{T} \end{aligned} \right\} \tag{9.13}$$

because chemical potentials are derivatives with respect to the mole numbers with the *natural independent variables* held constant.

## 9.2 CRITERIA OF EQUILIBRIUM AND SPONTANEITY IN SYSTEMS OF VARIABLE COMPOSITION

The criteria for spontaneity and equilibrium developed in Chapter 7 [Equations (7.8), (7.9), and (7.18)], that is,

$$dA \leq 0 \text{ (constant } T, V)$$

$$dG \leq 0 \text{ (constant } T, P)$$

and an additional equation for  $Y$ ,

$$dY \geq 0 \text{ (constant } T, P) \quad (9.14)$$

are valid for all closed systems in which only  $PdV$  work is performed. Similarly, Equation (7.79),

$$dG \leq DW_{\text{net}} \text{ (constant } T, P)$$

is valid for all closed systems in which work other than pressure-volume work is performed. In this expression, the equality applies to a reversible process and the inequality applies to an irreversible process, whether the change of state is spontaneous or nonspontaneous. If the change of state is spontaneous,  $dG < 0$  and  $DW_{\text{net}} < 0$ , so that in absolute magnitude,  $|dG| \geq |DW_{\text{net}}|$ . If the change of state is nonspontaneous,  $dG > 0$  and  $DW_{\text{net}} > 0$ , so that  $|dG| \leq |DW_{\text{net}}|$ . Thus, for a spontaneous change of state, the magnitude of  $dG$  is equal to the maximum non- $PV$  work that can be performed by the system, whereas, for a nonspontaneous change of state, the magnitude of  $dG$  is equal to the minimum non- $PV$  work that must be performed on the system to bring about the change in state. As  $G$  is a state function, the value of  $dG$  is the same for a given change of state, whether it is carried out reversibly or irreversibly; it is the value of  $dW$  that depends on reversibility.

If temperature and pressure are constant, we can conclude from Equation (9.9) that

$$dG = \sum_i \mu_i dn_i \quad (9.15)$$

and

$$dY = -\frac{1}{T} \sum_i \mu_i dn_i \quad (9.16)$$

which means that the criteria for spontaneity and equilibrium become (when the only constraint on the system is the constant pressure of the atmosphere and only  $PdV$  work is performed)

$$\sum_i \mu_i dn_i \leq 0 \text{ (constant } T, P) \quad (9.17)$$

When the system is placed under additional constraints, the relationships for non- $PdV$  work are

$$\sum_i \mu_i dn_i \leq DW_{\text{net}} \text{ (constant } T, P) \quad (9.18)$$

in which the equality applies to a reversible process and the inequality applies to an irreversible process. It can be shown that Equations (9.17) and (9.18) are general criteria for equilibrium and spontaneity and are not limited to constant temperature and pressure. However, it is with these limitations that we will apply the criteria.

The chemical potential for chemical, biological, or geological systems is analogous to the height, or gravitational potential, for a gravitational system; chemical, biological, or geological systems change spontaneously in the direction of decreasing chemical potential, just as an object in a gravitational field moves spontaneously in the direction of decreasing gravitational potential (downward).

### 9.3 RELATIONSHIPS AMONG PARTIAL MOLAR PROPERTIES OF A SINGLE COMPONENT

Generally, the thermodynamic relationships that we have developed for extensive thermodynamic properties also apply to partial molar properties. Thus, as [Equation (7.17)]

$$G = H - TS$$

we can obtain by differentiation with respect to  $n_i$ , (at constant temperature, pressure, and other mole numbers  $n_j$ )

$$\left(\frac{\partial G}{\partial n_i}\right)_{T,P,n_j} = \left(\frac{\partial H}{\partial n_i}\right)_{T,P,n_j} - T\left(\frac{\partial S}{\partial n_i}\right)_{T,P,n_j} \tag{9.19}$$

or, from the definition of a partial molar quantity [Equation (9.12)],

$$\mu_i = G_{mi} = H_{mi} - TS_{mi} \tag{9.20}$$

Similarly, from the relationship [Equation (4.55)]

$$\left(\frac{\partial H}{\partial T}\right)_P = C_P$$

we can write

$$\left(\frac{\partial H_{mi}}{\partial T}\right)_P = C_{Pm_i} \tag{9.21}$$

because the value of the cross-derivative of a thermodynamic property is independent of the order of differentiation [Equation (2.27)]. That is,

$$\left[\frac{\partial^2 H}{\partial T \partial n_i}\right]_{P,n_j} = \left[\frac{\partial}{\partial T} \left(\frac{\partial H}{\partial n_i}\right)_{T,P,n_j}\right]_{P,n_i,n_j} = \left(\frac{\partial H_{mi}}{\partial T}\right)_{P,n_i,n_j} \tag{9.22}$$

and

$$\left[\frac{\partial^2 H}{\partial n_i \partial T}\right]_{P,n_j} = \left[\frac{\partial}{\partial n_i} \left(\frac{\partial H}{\partial T}\right)_{P,n_i,n_j}\right]_{T,P,n_j} = \left(\frac{\partial C_P}{\partial n_i}\right)_{T,P,n_j} = C_{Pm_i} \tag{9.23}$$



On the same basis we can state

$$\left(\frac{\partial \mu_i}{\partial T}\right)_P = \left(\frac{\partial G_{mi}}{\partial T}\right)_P = -S_{mi} \quad (9.24)$$

and

$$\left(\frac{\partial \mu_i}{\partial P}\right)_T = \left(\frac{\partial G_{mi}}{\partial P}\right)_T = V_{mi} \quad (9.25)$$

where the derivatives are taken at constant composition as well as at constant pressure or constant temperature.

#### 9.4 RELATIONSHIPS BETWEEN PARTIAL MOLAR QUANTITIES OF DIFFERENT COMPONENTS

Extensive thermodynamic properties at constant temperature and pressure are homogeneous functions of degree 1 of the mole numbers. From Euler's theorem [Equation (2.33)] for a homogeneous function of degree  $n$

$$x \left(\frac{\partial f}{\partial x}\right)_y + y \left(\frac{\partial f}{\partial y}\right)_x = nf(x, y)$$

For a general two-component system and any extensive thermodynamic property  $J$ , we can write

$$J = f(n_1, n_2)$$

and

$$n_1 \left(\frac{\partial J}{\partial n_1}\right)_{T,P,n_2} + n_2 \left(\frac{\partial J}{\partial n_2}\right)_{T,P,n_1} = J \quad (9.26)$$

From the definition of partial molar quantities [Equation (9.12)], Equation (9.26) can be written as

$$n_1 J_{m1} + n_2 J_{m2} = J \quad (9.27)$$

Like  $J$ , both  $J_{m1}$  and  $J_{m2}$  are functions of  $T$  and  $P$  and the system composition.

Although the function  $J$  is a homogeneous function of the mole numbers of degree 1, the partial molar quantities,  $J_{m1}$  and  $J_{m2}$  are homogeneous functions of degree 0; that is, the partial molar quantities are *intensive* variables. This statement can be proved by the following procedure. Let us differentiate both sides of Equation (2.32) with respect to  $x$ :

$$\frac{\partial f(\lambda x, \lambda y, \lambda z)}{\partial x} = \lambda^n \frac{\partial f(x, y, z)}{\partial x} \quad (9.28)$$

If we divide both sides by  $\lambda$ , we obtain

$$\frac{1}{\lambda} \frac{\partial f(\lambda x, \lambda y, \lambda z)}{\partial x} = \lambda^{n-1} \frac{\partial f(x, y, z)}{\partial x} \quad (9.29)$$

We can rewrite Equation (9.29) in the common alternative notation for derivatives:

$$f'(\lambda x, \lambda y, \lambda z) = \lambda^{n-1} f'(x, y, z) \quad (9.30)$$

Equation (9.30) is an analogue of Equation (2.32) for the first derivative function, and it defines the degree of homogeneity of the partial derivative function  $f'$  and states that its degree of homogeneity is  $n - 1$ , that is, one less than the degree of homogeneity  $n$  of the original function  $f$ . Because they are homogeneous functions of the mole numbers of degree 0, the partial molar quantities, although still functions of  $n_1$  and  $n_2$ , are functions only of the ratio  $n_1/n_2$ , and thus, they are independent of the size of the system.

Differentiation of Equation (9.27) leads to

$$dJ = n_1 dJ_{m1} + J_{m1} dn_1 + n_2 dJ_{m2} + J_{m2} dn_2 \quad (9.31)$$

As at constant pressure and temperature  $J$  is a function of two variables,  $f(n_1, n_2)$ , the following equation is valid for the total differential:

$$\begin{aligned} dJ &= \left( \frac{\partial J}{\partial n_1} \right)_{n_2} dn_1 + \left( \frac{\partial J}{\partial n_2} \right)_{n_1} dn_2 \\ &= J_{m1} dn_1 + J_{m2} dn_2 \end{aligned} \quad (9.32)$$

If we equate Equations (9.31) and (9.32), we obtain

$$n_1 dJ_{m1} + J_{m1} dn_1 + n_2 dJ_{m2} + J_{m2} dn_2 = J_{m1} dn_1 + J_{m2} dn_2$$

or

$$n_1 dJ_{m1} + n_2 dJ_{m2} = 0 \quad (9.33)$$

Equation (9.33) is one of the most useful relationships between partial molar quantities. When applied to the chemical potential, it becomes

$$n_1 d\mu_1 + n_2 d\mu_2 = 0 \quad (9.34)$$

which is called the *Gibbs-Duhem equation* at constant temperature and pressure. This equation shows that in a two-component system, only one of the chemical potentials can vary independently at constant  $T$  and  $P$ .

It follows from Equation (9.33) that

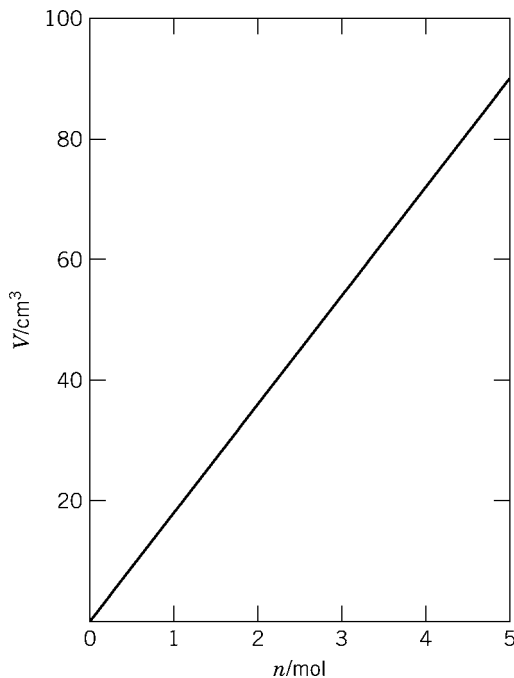
$$n_1 \frac{dJ_{m1}}{dn_1} + n_2 \frac{dJ_{m2}}{dn_1} = 0 \quad (9.35)$$

This equation is very useful in deriving certain relationships between the partial molar quantity for a solute and that for the solvent. An analogous equation can be written for the derivatives with respect to  $dn_2$ .

### Partial Molar Quantities for Pure Phase

If a system is a single, pure phase, a graph of any extensive thermodynamic property plotted against mole number at constant temperature and pressure gives a straight line passing through the origin (again neglecting surface effects). The data for the volume of water are given in Figure 9.1. The slope of the line gives the partial molar volume

$$V_m = \left( \frac{\partial V}{\partial n} \right)_{T,P} = \frac{V}{n} = V_m^\bullet \quad (9.36)$$



**Figure 9.1.** Volume of a pure phase at specified temperature and pressure. Data for water at 273.16 K and 100 kPa from the NIST WebBook on saturation properties for water. (<http://www.webbook.nist.gov/chemistry>)

in which  $V_m^\bullet$  is the molar volume of the pure phase. Similarly, for any extensive thermodynamic property  $J$  of a pure phase

$$J_m = \frac{J}{n} = J_m^\bullet \quad (9.37)$$

## 9.5 ESCAPING TENDENCY

### Chemical Potential and Escaping Tendency

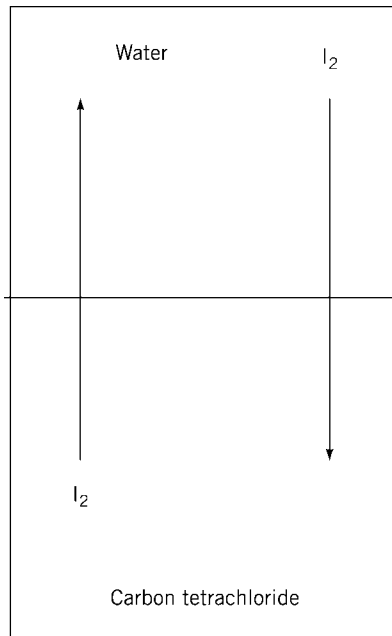
G. N. Lewis proposed the term “escaping tendency” to give a strong kinetic-molecular flavor to the concept of the chemical potential. Let us consider two solutions of iodine, in water and carbon tetrachloride, which have reached equilibrium with each other at a fixed pressure and temperature (Fig. 9.2). In this system at equilibrium, let us carry out a transfer of an infinitesimal quantity of iodine from the water phase to the carbon tetrachloride phase. On the basis of Equation (9.17), we can say that

$$\mu_{I_2(H_2O)} dn_{I_2(H_2O)} + \mu_{I_2(CCl_4)} dn_{I_2(CCl_4)} = 0 \quad (9.38)$$

In this closed system, any loss of iodine from the water phase is accompanied by an equivalent gain in the carbon tetrachloride thus,

Hence 
$$- dn_{I_2(H_2O)} = dn_{I_2(CCl_4)} \quad (9.39)$$

$$\mu_{I_2(H_2O)} dn_{I_2(H_2O)} + \mu_{I_2(CCl_4)} [-dn_{I_2(H_2O)}] = 0 \quad (9.40)$$



**Figure 9.2.** Schematic diagram of equilibrium distribution of iodine between water and carbon tetrachloride at fixed temperature and pressure.

It follows that

$$\mu_{\text{I}_2(\text{H}_2\text{O})} = \mu_{\text{I}_2(\text{CCl}_4)} \quad (9.41)$$

for this system in equilibrium at constant pressure and temperature. Thus, at equilibrium, the chemical potential of the iodine is the same in all phases in which it is present, or the escaping tendency of the iodine in the water is the same as that of the iodine in the carbon tetrachloride. We can return to the analogy with gravitational potential; stating that the iodine in the two phases have the same chemical potential is analogous to saying that two bodies at the same altitude have the same gravitational potential.

It also may be helpful to consider the situation in which the iodine will diffuse spontaneously (at constant pressure and temperature) from the water into the carbon tetrachloride, a case in which the concentration in the water phase is greater than that which would exist in equilibrium with the carbon tetrachloride phase. From Equation (9.17), we can write

$$\mu_{\text{I}_2(\text{H}_2\text{O})}dn_{\text{I}_2(\text{H}_2\text{O})} + \mu_{\text{I}_2(\text{CCl}_4)}dn_{\text{I}_2(\text{CCl}_4)} < 0 \quad (9.42)$$

For the spontaneous diffusion of iodine, Equation (9.39) is valid in this closed system. Hence,

$$\mu_{\text{I}_2(\text{H}_2\text{O})}dn_{\text{I}_2(\text{H}_2\text{O})} + \mu_{\text{I}_2(\text{CCl}_4)}[-dn_{\text{I}_2(\text{H}_2\text{O})}] < 0 \quad (9.43)$$

or

$$[\mu_{\text{I}_2(\text{H}_2\text{O})} - \mu_{\text{I}_2(\text{CCl}_4)}]dn_{\text{I}_2(\text{H}_2\text{O})} < 0 \quad (9.44)$$

As the water loses iodine,

$$dn_{\text{I}_2(\text{H}_2\text{O})} < 0 \quad (9.45)$$

That is,  $dn$  is a negative number. In such a case, Equation (9.44) is valid only if the difference in chemical potentials is a positive number. Therefore

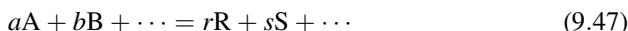
$$\mu_{\text{I}_2(\text{H}_2\text{O})} > \mu_{\text{I}_2(\text{CCl}_4)} \quad (9.46)$$

Thus, we may say that the escaping tendency of the iodine is greater in the water than in the carbon tetrachloride phase, and the chemical potentials in the two phases describe the spontaneous direction of transport from one phase to the other.

In general, when the chemical potential of a given species is greater in one phase than in a second, we also shall say that the escaping tendency is greater in the former case than in the latter. The escaping tendency thus is a qualitative phrase, which corresponds to the property given precisely by the chemical potential. Therefore, the escaping tendency or the chemical potential can be used to determine the spontaneous direction of transport.

## 9.6 CHEMICAL EQUILIBRIUM IN SYSTEMS OF VARIABLE COMPOSITION

We can apply the criterion of equilibrium expressed in Equation (9.17) to chemically reacting systems. Consider the reaction



in which all reactants and products are in the same phase. If this chemical reaction is at equilibrium at a fixed pressure and temperature, it follows from Equation (9.15) and Equation (9.17) that

$$dG = \mu_A dn_A + \mu_B dn_B + \cdots + \mu_R dn_R + \mu_S dn_S + \cdots = 0 \quad (9.48)$$

However, the various  $dn$ 's in Equation (9.48) are not independent, but, in view of the stoichiometry of the reaction of Equation (9.47), they must be related as follows:

$$-\frac{dn_A}{a} = -\frac{dn_B}{b} = \cdots = \frac{dn_R}{r} = \frac{dn_S}{s} = \cdots \quad (9.49)$$

As reactants disappear and products appear in the reaction, the corresponding  $dn$ 's in Equation (9.49) have opposite signs. In view of the series of equalities in this equation, let us define a quantity  $d\xi$  such that

$$d\xi = -\frac{dn_A}{a} = \cdots = \frac{dn_R}{r} = \cdots = \frac{dn_i}{\nu_i} \quad (9.50)$$

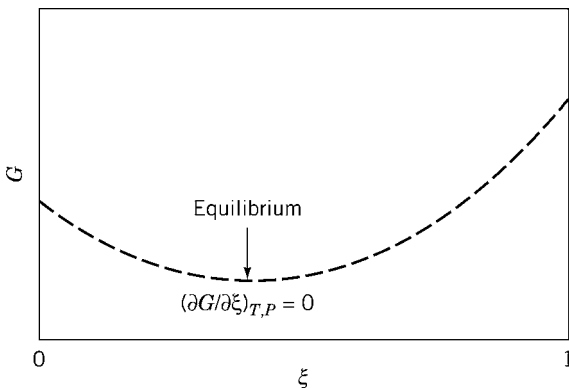
in which  $\nu_i$  is merely a generalized notation for the dimensionless *stoichiometric coefficients*,  $-a$ ,  $-b$ ,  $r$ ,  $s$ , and so on. The quantity  $\xi$  is called the *extent of reaction* or the *progress variable*, and it has the dimensions of *amount of substance* (Table 2.1) and has the unit mol. From the relationships of Equation (9.50), Equation (9.48) can be rewritten as

$$dG = -a\mu_A d\xi - b\mu_B d\xi - \cdots + r\mu_R d\xi + s\mu_S d\xi + \cdots = 0 \quad (9.51)$$

Alternatively, we can say that

$$\left(\frac{\partial G}{\partial \xi}\right)_{T,P} = r\mu_R + s\mu_S - a\mu_A - b\mu_B = 0 \quad (9.52)$$

is a criterion of equilibrium at constant temperature and pressure. The derivative  $(\partial G/\partial \xi)_{T,P}$  is the slope of a plot of the Gibbs function of the system  $G$  against  $\xi$  the progress variable. When  $\xi = 0$ , the system is all reactants, and when  $\xi = 1$ , the system is all products. At equilibrium,  $G$  is at a minimum, and the slope is equal to zero. Such a graph is given in Figure 9.3.



**Figure 9.3.** A graph of the Gibbs function  $G$  as a function of the progress variable  $\xi$ , which shows equilibrium at the minimum.

If Equation (9.52) is integrated with respect to  $\xi$  from  $\xi = 0$  to  $\xi = 1$  at constant values of the chemical potentials (fixed composition of the reacting mixture), then we obtain, at equilibrium,

$$\Delta G_m = G_{m2} - G_{m1} = \int_0^1 \left( \frac{\partial G}{\partial \xi} \right)_{T,P} d\xi = \sum v_i \mu_i = 0 \quad (9.53)$$

in which it is understood that  $v_i$  is a negative number for the stoichiometric coefficients of the reactants and a positive number for the products. The result is a molar quantity, because the integration leads to a *mole of reaction* in the sense given in the definition of mole in Table 2.1. As the composition of the reacting mixture does not change when one mole of reaction occurs, we say that we are using an “infinite copy model,” which is a system so large that the conditions of constant composition are satisfied.

Another way of writing Equation (9.53) is

$$\sum (|v_i| \mu_i)_{\text{reactants}} = \sum (|v_i| \mu_i)_{\text{products}} \quad (9.54)$$

The concept of escaping tendency also can be applied to the chemical reaction in Equation (9.47). At equilibrium, from Equation (9.54), we can say that the sum of the escaping tendencies of the reactants is equal to the sum of the escaping tendencies of the products.

For a chemical transformation capable of undergoing a spontaneous change, it follows from Equations (9.17) and (9.50) that

$$\sum v_i \mu_i < 0 \quad (9.55)$$

or that

$$\sum (|v_i|\mu_i)_{\text{reactants}} > \sum (|v_i|\mu_i)_{\text{products}} \quad (9.56)$$

Thus, for a spontaneous reaction, we can say that the sum of the escaping tendencies for the reactants is greater than the sum of the escaping tendencies for the products.

We can compare the *sums* of  $v_i\mu_i$  for reactants and products to arrive at a decision as to whether a transformation is at equilibrium or capable of a spontaneous change. Although we can compare escaping tendencies or  $\mu$ 's of a given substance under different conditions at constant temperature, it is meaningless to compare individual escaping tendencies of different substances because we have no way of determining absolute values of  $\mu$ . For similar reasons, we cannot compare escaping tendencies of a single substance at different temperatures.

## EXERCISES

- 9.1. Show that  $\mu_i$  is equal to the four partial derivatives in Equation (9.11).
- 9.2. Show that  $\sum_i \mu_i dn_i \leq 0$  is a criterion of spontaneity and equilibrium when only  $PdV$  work is performed at (a) constant  $T, V$ ; (b) constant  $S, P$ ; (c) constant  $S, V$ ; and (d) constant  $U, V$ .
- 9.3. Show that

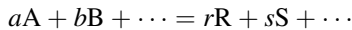
$$\left(\frac{\partial S_m}{\partial P}\right)_T = -\left(\frac{\partial V_m}{\partial T}\right)_P$$

- 9.4. Starting with the relationship for the corresponding extensive quantities, show that

- a.  $\left(\frac{\partial G_{mi}}{\partial P}\right)_{T, X_i, X_j} = V_{mi}$
- b.  $\left(\frac{\partial G_{mi}}{\partial T}\right)_{P, X_i, X_j} = -S_{mi}$
- c.  $G_{mi} = H_{mi} + T\left(\frac{\partial G_{mi}}{\partial T}\right)_{P, X_i, X_j} \quad (9.57)$
- d.  $\left(\frac{\partial(\mu/T)}{\partial T}\right)_{P, X_i, X_j} = -\frac{H_{mi}}{T^2}$
- e.  $\left(\frac{\partial Y_{mi}}{\partial P}\right)_{T, X_i, X_j} = -\frac{V_{mi}}{T}$



9.5. For a general chemical transformation



at a fixed temperature, Equation (9.52) is

$$\left(\frac{\partial G}{\partial \xi}\right)_{P,T} = 0$$

in which  $G$  is the total Gibbs function of all components and  $\xi$  is the extent of reaction. Verify that

$$\begin{aligned} \text{a. } & \left(\frac{\partial A}{\partial \xi}\right)_{V,T} = 0 \quad \text{and} \\ \text{b. } & \left(\frac{\partial Y}{\partial \xi}\right)_{P,T} = 0 \end{aligned} \quad (9.58)$$

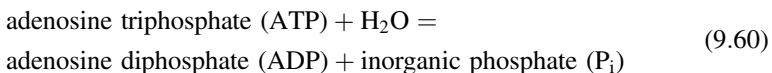
are valid if the system is at equilibrium.

9.6. For a system in which equilibrium between pure solid solute and solute in solution is maintained as the temperature is changed at constant pressure, show that

$$\left(\frac{\partial \mu_{1(\text{sat soln})}}{\partial T}\right)_P = -S_{m1} - \frac{X_2}{X_1}(S_{m2} - S_{m2}^\bullet) \quad (9.59)$$

in which  $X_2$  and  $X_1$  are mole fractions of solute and solvent, respectively;  $S_{m2}$  and  $S_{m1}$  are partial molar entropies; and  $S_{m2}^\bullet$  is the molar entropy of pure solid solute.

9.7. For many biochemical reaction, such as the hydrolysis of adenosine triphosphate,



the equilibrium constant is written as

$$K_{\text{obs}} = \frac{[\text{ADP}][\text{P}_i]}{[\text{ATP}]} \quad (9.61)$$

in which the concentrations are total concentrations of the species shown and their products of ionization. Since the species whose concentrations are given in Equation (9.60) ionize as weak acids and also form complexes with  $\text{Mg}^{2+}$ , the value of  $K_{\text{observed}}$  and the value of  $\Delta Y_{m,\text{observed}}$  are function of  $T$ , pH, and pMg at constant pressure (pMg =  $-\log[\text{Mg}^{2+}]$ ) [1]. An equation for the total differential of  $\Delta Y_m^\circ$  can be written as

$$d\Delta Y_m^\circ = \left(\frac{\partial \Delta Y_m^\circ}{\partial T}\right)_{\text{pH,pMg}} dT + \left(\frac{\partial \Delta Y_m^\circ}{\partial \text{pH}}\right)_{T,\text{pMg}} d\text{pH} + \left(\frac{\partial \Delta Y_m^\circ}{\partial \text{pMg}}\right)_{T,\text{pH}} d\text{pMg} \quad (9.62)$$

It also can be shown that

$$\left(\frac{\partial \Delta Y_m^\circ}{\partial \text{pH}}\right)_{T, \text{pMg}} = 2.3 R n_H \quad (9.63)$$

and

$$\left(\frac{\partial \Delta Y_m^\circ}{\partial \text{pMg}}\right)_{T, \text{pH}} = 2.3 R n_{\text{Mg}} \quad (9.64)$$

in which  $n_H$  is the number of  $\text{H}^+$  ions produced in the reaction in Equation (9.59) and  $n_{\text{Mg}}$  is the number of  $\text{Mg}^{2+}$  ions produced.

a. Show that

$$\left(\frac{\partial \Delta H_m^\circ}{\partial \text{pH}}\right)_{T, \text{pMg}} = 2.3 RT^2 \left(\frac{\partial n_H}{\partial T}\right)_{\text{pH}, \text{pMg}} \quad (9.65)$$

b. Show that

$$\left(\frac{\partial \Delta H_m^\circ}{\partial \text{pMg}}\right)_{T, \text{pH}} = 2.3 RT^2 \left(\frac{\partial n_{\text{Mg}}}{\partial T}\right)_{\text{pH}, \text{pMg}} \quad (9.66)$$

c. Show that

$$\left(\frac{\partial \Delta C_{Pm}^\circ}{\partial \text{pH}}\right)_{T, \text{pMg}} = 2.3 RT \left[ 2 \left(\frac{\partial n_H}{\partial T}\right)_{\text{pH}, \text{pMg}} + T \left(\frac{\partial^2 n_H}{\partial T^2}\right)_{\text{pH}, \text{pMg}} \right] \quad (9.67)$$

d. Show that

$$\left(\frac{\partial n_H}{\partial \text{pMg}}\right)_{T, \text{pH}} = \left(\frac{\partial n_{\text{Mg}}}{\partial \text{pH}}\right)_{T, \text{pMg}} \quad (9.68)$$

- 9.8.** Usually, chemical reactions are carried out in vessels that fit readily on a desktop so that the difference in gravitational energy at the top and bottom of the vessel is negligible. However, in some situations, a very high cylindrical vessel may be used; in which case, the gravitational energy of a portion of the material of fixed total mass  $m$  at the top is significantly different from that at the bottom.

In this situation, the Gibbs function  $G$  may be a function of  $h$ , the height above ground level, as well as of  $T$ ,  $P$ , and  $n_i$ .

- a. Write an equation for  $dG$  for this situation.
- b. It can be shown that

$$\left(\frac{\partial G}{\partial h}\right)_{T,P,n_i} = mg \quad (9.69)$$

Rewrite the equation in (a) accordingly.

- c. Starting with the fundamental definition of  $G$ , consider a system of mass  $m$  that undergoes a reversible change in height in a gravitational field at constant pressure and temperature, and show that  $dG = mgdh$ .
- d. Using the results in (b) and (c), find an equation for  $\sum \mu_i dn_i$ .
- e. For a system of many components  $i$  at constant pressure and temperature and at any height  $h$

$$G = \sum n_i \mu_i \quad (9.70)$$

Assuming this relationship plus the result in (d), find an equation for  $\sum n_i d\mu_i$ .

## REFERENCE

1. R. A. Alberty, *J. Am. Chem. Soc.* **91**, 3899 (1969).

## CHAPTER 10

---

# MIXTURES OF GASES AND EQUILIBRIUM IN GASEOUS MIXTURES

---

In this chapter we will apply the concepts developed in Chapter 11 to gaseous systems, first to mixtures of ideal gases, then to pure real gases, and finally to mixtures of real gases.

### 10.1 MIXTURES OF IDEAL GASES

In Chapter 5, we defined an ideal gas on the basis of two properties<sup>1</sup>:

$$PV = nRT \quad (5.1)$$

and

$$\left(\frac{\partial U}{\partial V}\right)_T = 0 \quad (5.2)$$

<sup>1</sup>We showed in Exercise 3 in Chapter 6 that Equation (5.2) can be derived from Equation (5.1) on the basis of the second law of thermodynamics.

We define an ideal gas mixture as one that follows Dalton's law:

$$P = n_1 \frac{RT}{V} + n_2 \frac{RT}{V} + \cdots = \frac{RT}{V} \sum_i n_i \quad (10.1)$$

It also follows from the second law of thermodynamics that the partial molar energy  $U_{mi}$  of each component is dependent only on the temperature and is independent of the pressure. We make part of the definition of an ideal gas mixture that  $U_{mi}$  is independent of the composition.

We will see that the relationships that are derived for mixtures of ideal gases will form convenient bases for the treatment of nonideal gases and solutions.

### The Entropy and Gibbs Function for Mixing Ideal Gases

The change in entropy and the change in the Gibbs function for mixing ideal gases can be calculated on the basis of a thought experiment with a van't Hoff equilibrium box (Fig. 10.1). Consider a cylinder in equilibrium with a thermal reservoir at temperature  $T$  so that the experiment is isothermal. Initially, both  $A$  and  $B$  are present in the separate compartments at the same pressure  $P$ . The two gases in the cylinder are separated by two semipermeable pistons; the one on the right is permeable only to  $A$ , and the one on the left is permeable only to  $B$ . To carry out the mixing process in a reversible manner, the external pressure  $P'$  on the right piston is kept infinitesimally less than the pressure of  $B$  in the mixture; and the external pressure  $P''$  on the left piston is kept infinitesimally less than the pressure of  $A$  in the mixture.

The work performed by the gases in the mixing process is the sum of the work performed by  $A$  in expanding against the left piston and the work performed by  $B$

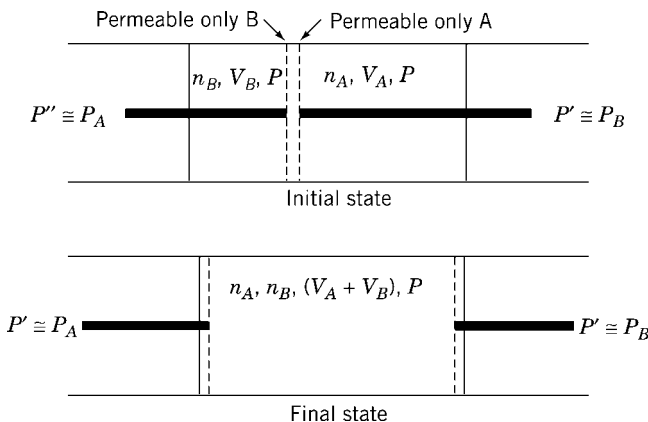


Figure 10.1. van't Hoff equilibrium box.

in expanding against the right piston. That is,

$$\begin{aligned}
 W_{\text{rev}} &= W_A + W_B \\
 &= - \int_{V_A}^{V_A+V_B} P dV - \int_{V_B}^{V_A+V_B} P dV \\
 &= - \int_{V_A}^{V_A+V_B} n_A RT \frac{dV}{V} - \int_{V_B}^{V_A+V_B} n_B RT \frac{dV}{V} \\
 &= -n_A RT \ln \frac{V_A + V_B}{V_A} - n_B RT \ln \frac{V_A + V_B}{V_B} \quad (10.2)
 \end{aligned}$$

As  $A$  and  $B$  initially were at the same temperature and pressure, and as the final mixture is at the original temperature, and the total pressure of the mixture is equal to the initial pressures of the individual gases, the volumes  $V_A$ ,  $V_B$ , and  $V_A + V_B$  are in the same proportion as the respective numbers of moles of gas. Thus, Equation (10.2) can be written as

$$\begin{aligned}
 W_{\text{rev}} &= -n_A RT \ln \frac{n_A + n_B}{n_A} - n_B RT \ln \frac{n_A + n_B}{n_B} \\
 &= n_A RT \ln \frac{n_A}{n_A + n_B} + n_B RT \ln \frac{n_B}{n_A + n_B} \\
 &= n_A RT \ln X_A + n_B RT \ln X_B \quad (10.3)
 \end{aligned}$$

in which  $X_A$  and  $X_B$  are the mole fractions of the two gases. As the mixing process is isothermal and the gases form an ideal mixture,  $\Delta U = 0$ , and

$$Q_{\text{rev}} = -W_{\text{rev}} = -n_A RT \ln X_A - n_B RT \ln X_B \quad (10.4)$$

Then from the entropy change in a reversible, isothermal process [Equation (6.72)]

$$\Delta S_{\text{mixing}} = \frac{Q_{\text{rev}}}{T} = -n_A R \ln X_A - n_B R \ln X_B \quad (10.5)$$

As both  $X_A$  and  $X_B$  are less than 1,  $\Delta S_{\text{mixing}}$  is a positive quantity.

For the reversible mixing, the entropy change in the surroundings is equal, but opposite in sign, and the total entropy change is zero. If the mixing process were allowed to proceed irreversibly by puncturing the two pistons,  $\Delta S$  for the system would be the same, but  $\Delta S$  for the surroundings would be zero because no work would be performed and no heat would be exchanged. Thus, the total change in entropy for the irreversible process would be positive.

For the isothermal process involving ideal gases,  $\Delta H$  is zero, and from Equation (7.26)

$$\Delta G_{\text{mixing}} = -T\Delta S_{\text{mixing}} \quad (10.6)$$

so that

$$\Delta G_{\text{mixing}} = n_A RT \ln X_A + n_B RT \ln X_B \quad (10.7)$$

### The Chemical Potential of a Component of an Ideal Gas Mixture

$\Delta G_{\text{mixing}}$  also is equal to the difference between the Gibbs function for the mixture and the Gibbs function for the unmixed gases. That is,

$$\begin{aligned} \Delta G_{\text{mixing}} &= G_{\text{mixture}} - G_{\text{puregases}} \\ &= [n_A \mu_A + n_B \mu_B]_{\text{mixed}} - [n_A G_{m,A}^{\bullet} + n_B G_{m,B}^{\bullet}]_{\text{unmixed}} \end{aligned} \quad (10.8)$$

where  $G_m^{\bullet}$  is the molar free energy of the pure gas. From Equation (7.43) and the ideal gas law, we can obtain for the change in Gibbs function in the isothermal expansion of an ideal gas:

$$\Delta G = nRT \ln \frac{P_2}{P_1} \quad (10.9)$$

If the change in state is the expansion of one mole of ideal gas from a standard pressure  $P^{\circ} = 0.1 \text{ MPa}$  to a pressure  $P$ , Equation (10.9) can be written as

$$\Delta G = G_m - G_m^{\circ} = RT \ln P/P^{\circ} \quad (10.10)$$

Substituting for  $G_m$  from Equation (10.10) into Equation (10.8), we obtain

$$\begin{aligned} \Delta G_{\text{mixing}} &= n_A \mu_A + n_B \mu_B - n_A (G_{m,A}^{\circ} + RT \ln P/P^{\circ}) \\ &\quad - n_B (G_{m,B}^{\circ} + RT \ln P/P^{\circ}) \end{aligned} \quad (10.11)$$

From Equations (10.7) and (10.11), we have

$$\begin{aligned} n_A RT \ln X_A + n_B RT \ln X_B &= n_A \mu_A + n_B \mu_B - n_A G_{m,A}^{\circ} - n_A RT \ln P/P^{\circ} \\ &\quad - n_B G_{m,B}^{\circ} - n_B RT \ln P/P^{\circ} \end{aligned} \quad (10.12)$$

The coefficients of  $n_A$  and  $n_B$  on the two sides of the equation must be equal: Thus,

$$RT \ln X_A = \mu_A - G_{m,A}^{\circ} - RT \ln P/P^{\circ} \quad (10.13)$$

Therefore

$$\begin{aligned} \mu_A &= G_{m,A}^{\circ} + RT \ln X_A + RT \ln P/P^{\circ} \\ &= G_{m,A}^{\circ} + RT \ln PX_A/P^{\circ} \end{aligned} \quad (10.14)$$

and similarly for  $\mu_B$ . We shall define the partial pressure of an ideal gas as the product of its mole fraction and the total pressure. Thus, we can write

$$\mu_A = G_{mA}^\circ + RT \ln p_A/P^\circ \quad (10.15)$$

The right-hand equality in Equation (10.10), which gives the molar free energy of a pure ideal gas, is of the same form as Equation (10.15), which gives the chemical potential of a component of an ideal gas mixture, except that for the latter, partial pressure is substituted for total pressure. If the standard state of a component of the mixture is defined as one in which the *partial pressure* of that component is 0.1 MPa, then

$$\mu_A^\circ = G_{mA}^\circ \quad (10.16)$$

and we can write

$$\mu_A = \mu_A^\circ + RT \ln p_A/P^\circ \quad (10.17)$$

### Chemical Equilibrium in Ideal Gas Mixtures

For the reaction [Equation (9.47) applied to a mixture of ideal gases]

$$aA(p_A) + bB(p_B) + \cdots = rR(p_R) + sS(p_s) + \cdots \quad (10.18)$$

we can substitute the expression in Equation (10.17) for the chemical potentials into Equation (9.53) that is

$$\begin{aligned} \Delta G_m = & -a(\mu_A^\circ + RT \ln p_A/P^\circ) - b(\mu_B^\circ + RT \ln p_B/P^\circ) \\ & + r(\mu_R^\circ + RT \ln p_R/P^\circ) + s(\mu_s^\circ + RT \ln p_s/P^\circ) = 0 \end{aligned} \quad (10.19)$$

or, if we gather together the chemical potential terms,

$$(r\mu_R^\circ + s\mu_s^\circ - a\mu_A^\circ - b\mu_B^\circ) = -RT \ln \left[ \frac{(p_R/P^\circ)^r (p_s/P^\circ)^s}{(p_A/P^\circ)^a (p_B/P^\circ)^b} \right]_{\text{equil}} \quad (10.20)$$

We can define the left side of Equation 10.20 as  $\Delta G_m^\circ$ , where the process described is one mole of reaction at constant chemical potential for reactants and products, that is, for a system large enough so that one mole of reaction can take place in the mixture without any significant change in composition or chemical potential, an *infinite-copy* model. As  $\Delta G_m^\circ$  is a constant at constant temperature, the quantity in brackets is also a constant at constant temperature, and, in particular, independent of the total pressure and the initial composition of the system. We therefore designate the quantity in brackets as  $K_P$ , which is the equilibrium constant in terms of partial pressures for a



mixture of ideal gases. Thus,

$$K_P = \left[ \frac{(p_R/P^\circ)^r (p_S/P^\circ)^s}{(p_A/P^\circ)^a (p_B/P^\circ)^b} \right]_{\text{equil}} \quad (10.21)$$

and

$$\Delta G_m^\circ = -RT \ln K_P \quad (10.22)$$

and

$$\Delta Y_m^\circ = R \ln K_P$$

because  $\Delta G_m^\circ = -T\Delta Y_m^\circ$ . The subscript P distinguishes the ideal gas equilibrium constant in terms of partial pressures from other forms for the constants that will be derived for real systems.

If we use the symbol  $Q^*$  for the quotient of pressures not at equilibrium on the right side of Equation (10.21), then we can write

$$\begin{aligned} \Delta G_m &= \Delta G_m^\circ + R \ln Q^* \\ &= -RT \ln K_P + RT \ln Q^* \\ &= RT \ln (Q^*/K_P) \end{aligned} \quad (10.23)$$

Thus, if the initial quotient of pressures is greater than  $K_P$ ,  $\Delta G_m$  is positive and the reaction will be spontaneous to the left, whereas if the initial quotient of pressures is less than  $K_P$ ,  $\Delta G_m$  is negative and the reaction will be spontaneous to the right.

The form of the equilibrium constant in Equation (10.21) is different from that presented in introductory courses. It has the advantages that 1) it is explicit that  $K_P$  is a dimensionless quantity; 2) it is explicit that the numerical value of  $K_P$  depends on the choice of standard state but not on the units used to describe the standard state pressure; the equilibrium constant has the same value whether  $P^\circ$  is expressed as 750.062 Torr, 0.98692 atm, 0.1 MPa, or 1 bar.

### Dependence of $K$ on Temperature

From the value of  $\Delta Y_m^\circ$  at a single temperature, it is possible to calculate the equilibrium constant  $K_P$  at that temperature. It is also desirable to be able to calculate  $K_P$  as a function of the temperature, so that it is not necessary to have values of  $\Delta Y_m^\circ$  at frequent temperature intervals. All that is required is to differentiate the relationship between  $\Delta Y_m^\circ$  and  $\ln K_P$  [Equation (10.22)] and to use Equation (7.57) for the derivative of  $\Delta Y_m^\circ$ . Then

$$\frac{\Delta H_m}{T^2} = R \left( \frac{\partial \ln K_P}{\partial T} \right)_P$$

and

$$\left(\frac{\partial \ln K_P}{\partial T}\right)_P = \frac{\Delta H_m}{RT^2} \quad (10.24)$$

When Equation (10.24) is applied to the temperature dependence of  $\ln K_P$ , where  $K_P$  applies to an isothermal transformation, the  $\Delta H_m^\circ$  that is used is the enthalpy change at zero pressure for gases and at infinite dilution for substances in solution (see Section 7.3).

We have observed in Chapter 4 that a general expression for  $\Delta H_m$  as a function of temperature can be written in the form [Equation (4.74)]

$$\Delta H_m = \Delta H_{m0} + \int \Delta C_{Pm} dT$$

If the heat capacities of the substances involved in the transformation can be expressed in the form of a simple power series [Equation (4.67)]

$$\frac{C_{Pm}}{R} = a_0 + a_1 T + a_2 T^2 + \dots$$

in which  $a_0$ ,  $a_1$ , and  $a_2$  are constants, then Equation (4.74) becomes

$$\Delta H_m = \Delta H_{m0} + R \left[ \Delta a_0 T + \frac{\Delta a_1}{2} T^2 + \frac{\Delta a_2}{3} T^3 + \dots \right] \quad (10.25)$$

in which the  $\Delta$ 's refer to the sums of the coefficients for the products minus the sums of the coefficients for the reactants. Equation (10.25) can be inserted into Equation (10.24), which then can be integrated at constant pressure. If terms higher than  $T^3$  are neglected, the result is

$$\begin{aligned} \int d \ln K_P &= \int \frac{\Delta H_m}{RT^2} dT \\ &= \int \left( \frac{\Delta a_0}{T} + \frac{\Delta a_1}{2} + \frac{\Delta a_2}{3} T + \frac{\Delta H_{m0}}{RT^2} \right) dT \end{aligned} \quad (10.26)$$

If the constant of integration is  $I$ , the result of the integration can be written as

$$\ln K_P = I + \Delta a_0 \ln T + \frac{\Delta a_1}{2} T + \frac{\Delta a_2}{6} T^2 - \frac{\Delta H_{m0}}{RT} \quad (10.27)$$

The value of  $\Delta H_{m0}$  can be found if the enthalpy of reaction is known at one temperature. Similarly, the constant  $I$  can be determined if  $\Delta H_{m0}$  and  $\ln K_P$  are known at one temperature.

**Comparison of Temperature Dependence of  $\Delta G_m^\circ$  and  $\ln K$  [1]**

$$\Delta Y_m^\circ = R \ln K$$

From Equation (10.22), when applied to a reaction in solution, we use  $K$ , not  $K_p$ ,

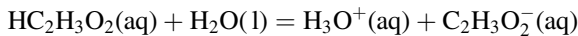
$$\Delta Y_m^\circ = R \ln K$$

or (10.28)

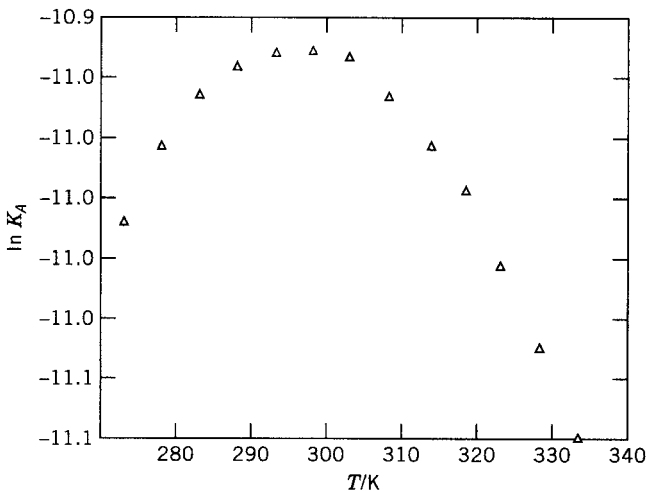
$$\Delta G_m^\circ = -RT \ln K$$

In view of the relationship in Equation (10.28), one might expect that changes in  $\Delta G_m^\circ$  and  $\ln K$  with temperature would be congruent. If  $K$  changes monotonically with temperature, this expectation is fulfilled. If, however,  $K$  goes through a maximum or minimum as temperature is changed,  $\Delta G_m^\circ$  may still change monotonically in one direction.

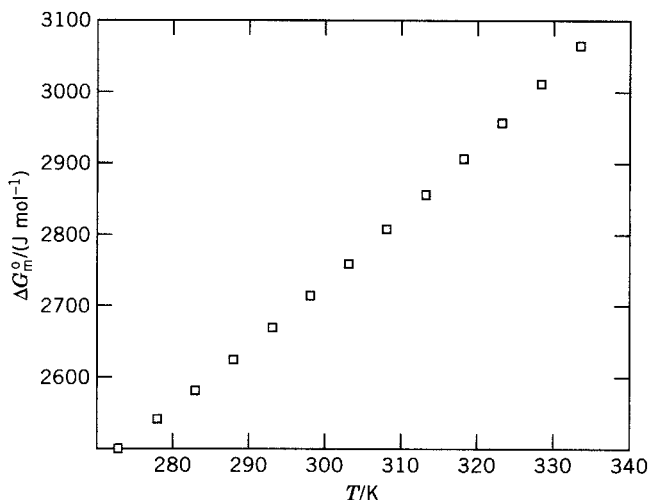
Such behavior is exhibited by the simple chemical reaction



Very precise, classic, measurements of the ionization constant of acetic acid were made many decades ago [2]. The dependence of  $\ln K$  on temperature is illustrated in Figure 10.2. As the temperature is increased from 273 K,  $\ln K$  and the degree of ionization increases gradually, reaching a maximum just below 298 K, and then



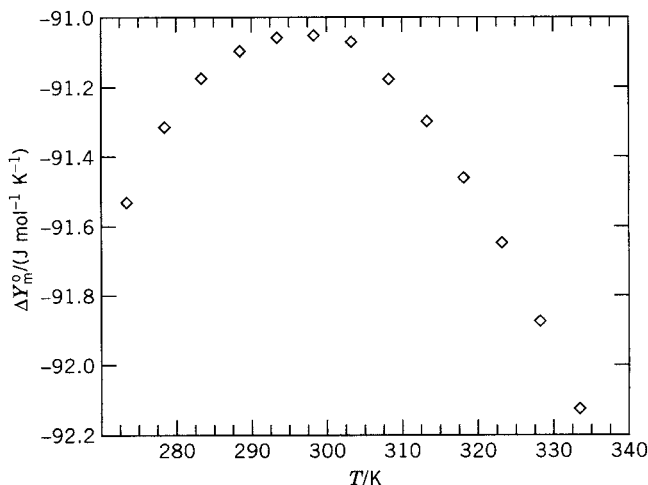
**Figure 10.2.** The temperature dependence of  $\ln K$  for the ionization of acetic acid. Data from Ref. 2.



**Figure 10.3.** The temperature dependence of  $\Delta G_m^\circ$  for the ionization of acetic acid. Data from Ref. 2.

decreases with increasing temperature. In contrast,  $\Delta G_m^\circ$  is a monotonically increasing function of the temperature (Fig. 10.3).

When we compare chemical reactions at a fixed temperature, that reaction with the more positive value of  $\Delta G_m^\circ$  is less “spontaneous,” less capable of progressing from reactants to products. On the other hand, when we compare a given reaction at different temperatures, a temperature with a more positive  $\Delta G_m^\circ$  may show a more



**Figure 10.4.** The temperature dependence of  $\Delta Y_m^\circ$  for the ionization of acetic acid. Data from Ref. 2.

spontaneous reaction, as can be observed from Figures 10.2 and 10.3. For example, the value of  $\Delta G_m^\circ$  for the ionization of acetic acid is  $5976.4 \text{ cal mol}^{-1}$  at 273 K and  $6489.6 \text{ cal mol}^{-1}$  at 298 K. Nevertheless, the degree of ionization is greater at 298 K,  $K = 1.754 \times 10^{-5}$ , than at 273 K,  $K = 1.657 \times 10^{-5}$ . In contrast to the Gibbs function, the Planck function  $\Delta Y_m^\circ$  does vary with temperature congruently with the extent of reaction, as measured by  $\ln K$ , as is illustrated in Figure 10.4.

## 10.2 THE FUGACITY FUNCTION OF A PURE REAL GAS

We expressed the molar free energy of a pure ideal gas as [Equation (10.10)]

$$G_{mA} = G_{mA}^\circ + RT \ln P/P^\circ$$

by substituting  $V = nRT/P$  in the integral

$$\Delta G = \int_{P^\circ}^P V dP \quad (10.28)$$

Similarly, we obtained the chemical potential of a component of an ideal gas mixture as [Equation (10.17)] from an analysis of the van't Hoff mixing experiment, using the same integral.

$$\mu_A = \mu_A^\circ + RT \ln p_A/P^\circ$$

It would be possible to apply Equation (10.22) to real gases by substituting a different empirical expression for  $V_m$  as a function of  $P$  for each gas, but no simple closed form is applicable to all gases. A simple form of the equation for the chemical potential and a simple form of the equation for an equilibrium constant that is independent of the gases involved is so convenient, however, that G. N. Lewis suggested an alternative procedure. He defined a new function, the *fugacity*  $f$ , with a universal relationship to the chemical potential, and let the dependence of  $f$  on  $P$  vary for different gases. The fugacity is defined to have the dimensions of pressure.

An advantage of the fugacity over the chemical potential as a measure of escaping tendency is that an absolute value of the fugacity can be calculated, whereas an absolute value of the chemical potential cannot be calculated.

One part of the definition of fugacity can be stated as

$$\mu = \mu^\circ + RT \ln \frac{f}{f^\circ} \quad (10.29)$$

in which  $\mu^\circ$  is a function only of the temperature. The standard chemical potential is characteristic of each gas and the standard state chosen. For a pure gas, the value of  $f^\circ$  is chosen equal to  $P^\circ$ , 0.1 MPa.

As all gases approach ideality as their pressure is decreased, and as Equation (10.29) is of the same form as Equation (10.14) for an ideal gas, it is convenient to complete the definition of  $f$  by stating

$$\lim_{P \rightarrow 0} \frac{f}{P} = 1 \tag{10.30}$$

That is, as the pressure approaches zero, the fugacity approaches the pressure. Figure 10.5 indicates the relationship between  $P$  and  $f$  for ideal and real gases. The standard state for a real gas is chosen as the state at which the fugacity is equal to 0.1 MPa, 1 bar, along a line extrapolated from values of  $f$  at low pressure, as indicated in Figure 10.5. The standard state for a real gas is then a hypothetical 0.1 MPa standard state.

From Equation (10.29), we can see that the change in the Gibbs function for the isothermal expansion of a real gas is

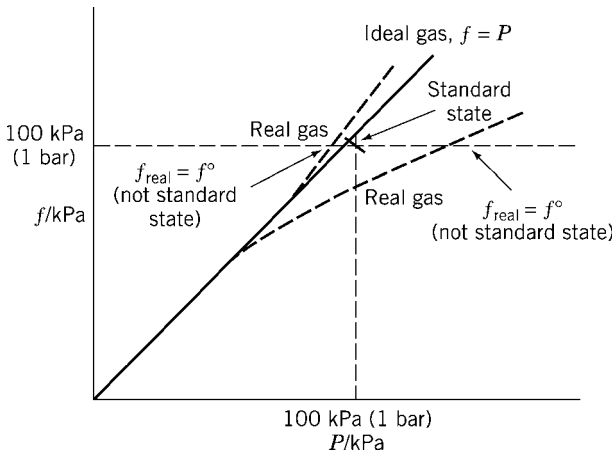
$$\Delta G = nRT \ln \frac{f_2}{f_1} \tag{10.31}$$

As the pressure approaches zero, Equation (10.30) applies and  $\Delta G$  approaches the value calculated from Equation (10.9).

### Change of Fugacity with Pressure

The dependence of fugacity on pressure can be derived by differentiating Equation (10.29):

$$\left(\frac{\partial \mu}{\partial P}\right)_T = RT \left[ \frac{\partial \ln (f/f^\circ)}{\partial P} \right]_T \tag{10.32}$$



**Figure 10.5.** Characteristics of the fugacity for ideal and real gases.

Combining Equation (10.31) with Equation (9.25), we have

$$\left[ \frac{\partial \ln f}{\partial P} \right]_T = \frac{V_m}{RT} \quad (10.33)$$

because  $f^\circ$  is independent of  $P$ .

This equation can be integrated to find a fugacity at one pressure from that at another:

$$RT \ln \frac{f_2}{f_1} = \int_{P_1}^{P_2} V_m dP \quad (10.34)$$

### Change of Fugacity with Temperature

Let us consider an isothermal process in which a gas is transformed from one state  $A$  at a pressure  $P$  to another  $A^*$  at a different pressure  $P^*$ . Such a transformation can be represented as follows:

$$A(P) = A^*(P^*) \quad (10.35)$$

The change in the Gibbs function for such a transformation is given by the expression

$$\begin{aligned} \Delta G &= \mu^* - \mu \\ &= RT \ln (f^*/f^\circ) - RT \ln (f/f^\circ) \\ &= RT \ln \frac{f^*}{f} \end{aligned} \quad (10.36)$$

and

$$\frac{\mu^*}{T} - \frac{\mu}{T} = R \ln (f^*/f) \quad (10.37)$$

The partial derivative of the fugacity with respect to temperature is given by

$$\left[ \frac{\partial(\mu^*/T)}{\partial T} \right]_{P^*} - \left[ \frac{\partial(\mu/T)}{\partial T} \right]_P = R \left( \frac{\partial \ln f^*}{\partial T} \right)_{P^*} - R \left( \frac{\partial \ln f}{\partial T} \right)_P \quad (10.38)$$

From Equation (9.57), we have

$$\left[ \frac{\partial(\mu^*/T)}{\partial T} \right]_{P^*} - \left[ \frac{\partial(\mu/T)}{\partial T} \right]_P = -\frac{H_m^*}{T^2} + \frac{H_m}{T^2} \quad (10.39)$$

Therefore,

$$\left( \frac{\partial \ln f^*}{\partial T} \right)_{P^*} - \left( \frac{\partial \ln f}{\partial T} \right)_P = -\frac{H_m^*}{RT^2} + \frac{H_m}{RT^2} \quad (10.40)$$

If the pressure  $P^*$  approaches zero, the ratio of the fugacity to the pressure approaches one, and we can write

$$\left(\frac{\partial \ln f^*}{\partial T}\right)_{P^*} = \left(\frac{\partial \ln P^*}{\partial T}\right)_{P^*} = 0 \quad (10.41)$$

If we substitute from Equation (10.40) into Equation (10.41), we obtain

$$\left(\frac{\partial \ln f}{\partial T}\right)_P = \frac{H_m^* - H_m}{RT^2} \quad (10.42)$$

in which  $H_m^*$  is the partial molar enthalpy of the substance in State  $A^*$ , that is, the state of zero pressure. Therefore, the difference ( $H_m^* - H_m$ ) is the change in molar enthalpy when the gas goes from State  $A$  to its state of zero pressure, that is, at infinite volume.

The pressure dependence of this enthalpy change is given by the expression

$$\left[\frac{\partial(H_m^* - H_m)}{\partial P}\right]_T = -\left(\frac{\partial H_m}{\partial P}\right)_T \quad (10.43)$$

because  $(\partial H^*/\partial P)_T$  is zero, as  $H_m^*$  is the partial molar enthalpy at a fixed (zero) pressure.

From Equation (5.68), we know that the pressure coefficient of the molar enthalpy of a gas is related to the Joule–Thomson coefficient  $\mu_{J,T}$  by the equation

$$\left(\frac{\partial H_m}{\partial P}\right)_T = -C_{Pm}\mu_{J,T}. \quad (10.44)$$

If we combine Equations (10.43) and (10.44), we find that

$$\left[\frac{\partial(H_m^* - H_m)}{\partial P}\right]_T = C_{Pm}\mu_{J,T}. \quad (10.45)$$

Because of this relationship between  $(H_m^* - H_m)$  and  $\mu_{J,T}$ , the former quantity frequently is referred to as the “Joule–Thomson enthalpy.” The pressure coefficient of this Joule–Thomson enthalpy change can be calculated from the known values of the Joule–Thomson coefficient and the heat capacity of the gas. Similarly, as  $(H_m^* - H_m)$  is a derived function of the fugacity, knowledge of the temperature dependence of the latter can be used to calculate the Joule–Thomson coefficient. As the fugacity and the Joule–Thomson coefficient are both measures of the deviation of a gas from ideality, it is not surprising that they are related.

### 10.3 CALCULATION OF THE FUGACITY OF A REAL GAS

Several methods have been developed for calculating fugacities from measurements of pressures and molar volumes of real gases.



### Graphical or Numerical Methods

**Using the  $\alpha$  Function.** A typical molar volume–pressure isotherm for a real gas is illustrated in Figure 10.6, together with the corresponding isotherm for an ideal gas. From Equation (10.34) we can write

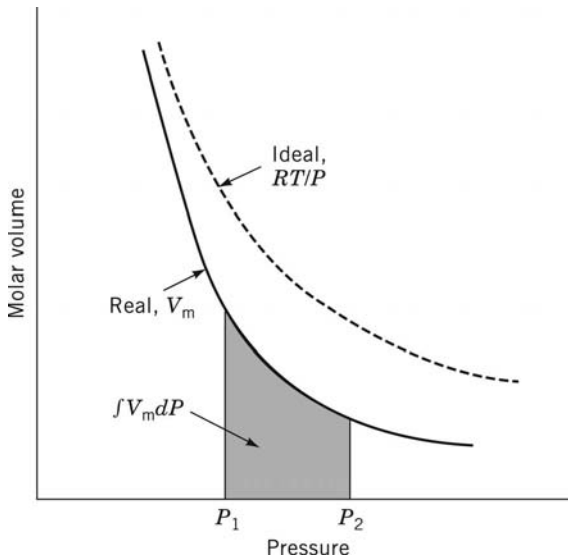
$$RT \ln \frac{f_2}{f_1} = \int_{P_1}^{P_2} V_m dP$$

The ratio of the fugacity  $f_2$  at the pressure  $P_2$  to the fugacity  $f_1$  at the pressure  $P_1$  can be obtained by graphical or numerical integration, as indicated by the area between the two vertical lines under the isotherm for the real gas in Figure 10.6. However, as  $P_1$  approaches zero, the area becomes infinite. Hence, this direct method is not suitable for determining absolute values of the fugacity of a real gas.

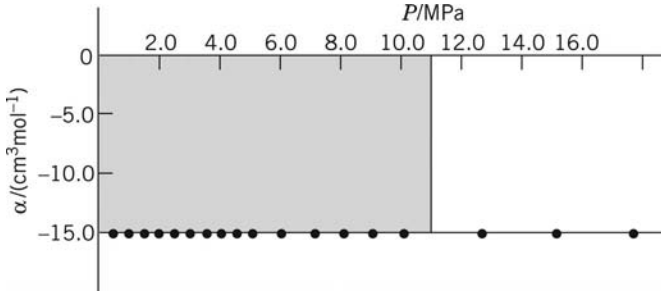
Equation (10.34) takes cognizance of only one part of the definition of fugacity. The second part of the definition states that although  $f$  approaches zero as  $P$  approaches zero, the ratio  $f/P$  approaches one. Hence, this ratio might be integrable to zero pressure.

If we take the pressure coefficient of the ratio  $f/P$ , we obtain

$$\left[ \frac{\partial \ln(f/P)}{\partial P} \right]_T = \left( \frac{\partial \ln f}{\partial P} \right)_T - \left( \frac{\partial \ln P}{\partial P} \right)_T \quad (10.46)$$



**Figure 10.6.** Comparison of molar volume–pressure isotherms for a possible real gas and an ideal gas.



**Figure 10.7.** The  $\alpha$  function for hydrogen gas at 300 K. Data from Ref. 3.

The pressure coefficient of  $\ln f$  is given by Equation (10.33),

$$\left(\frac{\partial \ln f}{\partial P}\right)_T = \frac{V_m}{RT}$$

in which  $V_m$  is the molar volume of the gas. Thus, Equation (10.46) becomes

$$\begin{aligned} \left[\frac{\partial \ln(f/P)}{\partial P}\right]_T &= \frac{V_m}{RT} - \frac{\partial \ln P}{\partial P} \\ &= \frac{V_m}{RT} - \frac{1}{P} \\ &= \frac{1}{RT} \left(V_m - \frac{RT}{P}\right) \end{aligned} \tag{10.47}$$

If we call the quantity within the parentheses  $-\alpha$ , that is, if

$$\alpha = \left(\frac{RT}{P} - V_m\right) \tag{10.48}$$

we obtain

$$\left[\frac{\partial \ln(f/P)}{\partial P}\right]_T = -\frac{\alpha}{RT} \tag{10.49}$$

Integration of this equation for isothermal conditions from zero pressure to some pressure  $P$  gives

$$\int_0^{\ln(f/P)} d \ln \frac{f}{P} = -\frac{1}{RT} \int_0^P \alpha dP \tag{10.50}$$

or

$$\ln \frac{f}{P} - \ln \left( \frac{f}{P} \right)_{P=0} = - \frac{1}{RT} \int_0^P \alpha \, dP \quad (10.51)$$

As  $f/P$  approaches one as  $P$  approaches zero, the second term on the left side of Equation (10.45) goes to zero. Hence

$$\ln \left( \frac{f}{P} \right) = - \frac{1}{RT} \int_0^P \alpha \, dP \quad (10.52)$$

Thus, to evaluate  $f$ , it is necessary to integrate  $\alpha \, dP$ . Both  $V_m$  and  $RT/P$  approach infinity as the pressure goes to zero. Nevertheless, the difference between them generally does not approach zero. Usually,  $\alpha$  can be measured for several pressures and an extrapolation can be made to zero pressure. A typical graph for  $\alpha$  (for hydrogen gas) is illustrated in Figure 10.7 [3]. The area under the curve from  $P = 0$  to any finite value of  $p$  can be obtained<sup>2</sup> either graphically or numerically (see Appendix A) to determine the integral in Equation (10.52).

This procedure of using a finite difference between two quantities, both of which become infinite, is of general usefulness. We also will use it in Chapter 19 to obtain the standard potential of a cell.

**Using the Compressibility Factor.** The behavior of most pure gases can be represented adequately by a single chart of the compressibility factor  $Z$ , which has been defined above in Equation (5.55).

$$Z = \frac{PV_m}{RT} \quad (10.53)$$

If a gas follows any two-parameter equation of state, such as the van der Waals or the Redlich–Kwong, it has been shown in Section 5.2 that  $Z$ , the compressibility factor, is a universal function of the reduced pressure  $P_r = P/P_c$  and the reduced temperature  $T_r = T/T_c$ . Then if  $Z$  is plotted as a function of  $P_r$ , at a given reduced temperature  $T_r$  all gases fit a single curve. At another reduced temperature  $T_r'$ , a new curve is obtained for  $Z$  versus  $P_r$ , but it too fits all gases. Gases at equal reduced pressures and reduced temperatures are said to be in *corresponding states*.

If  $Z$  could be related to  $\alpha$ , it would be possible to plot some function of the fugacity against  $P_r$  at a given value of  $T_r$  for which all gases would fit the same curve. At another reduced temperature  $T_r'$ , a new curve would be obtained.

<sup>2</sup>Several investigators report values of  $\alpha$  that deviate from  $-15 \text{ cm}^3 \text{ mol}^{-1}$  at pressures below 1 MPa, but some values are greater than  $-15 \text{ mol}^{-1}$  and some are less. The limiting value of  $\alpha$  at zero pressure must be equal to  $-B$  [Equation (5.59)], which is given as  $14.8 \pm 0.5$  in Ref. 4. It would seem, therefore, that the disagreement in the data at low pressure is due to the difficulty in measuring a small difference between two very large numbers.

Let us then derive a relationship between  $\alpha$  and  $Z$ . It follows from Equation (10.49) that

$$\alpha = \frac{RT}{P} - V_m = \frac{RT}{P} \left( 1 - \frac{PV_m}{RT} \right) = \frac{RT}{P} (1 - Z) \tag{10.54}$$

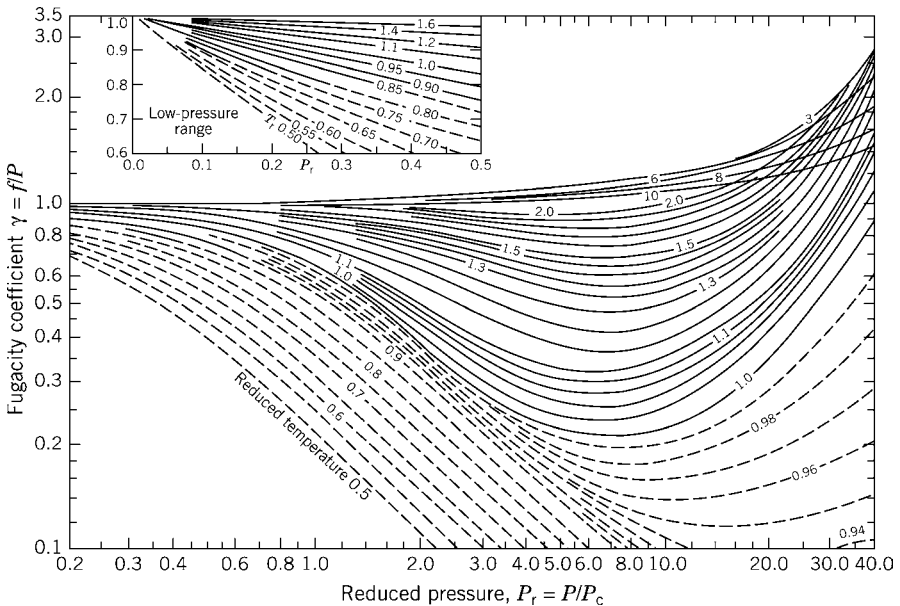
From Equation (10.48) and Equation (10.54), we obtain

$$d \ln \frac{f}{P} = - \frac{1}{RT} \frac{RT}{P} (1 - Z) dP \tag{10.55}$$

which by integration yields

$$\ln \frac{f}{P} = - \int_0^P \frac{1 - Z}{P} dP \tag{10.56}$$

The integration of Equation (10.56) can be carried out, graphically or numerically, to provide a chart of  $f/P$  [or  $\gamma$ , the *fugacity coefficient* [5]] as a function of  $P_r$  and  $T_r$ . A single chart of “universal fugacity coefficients” is applicable to all pure gases within the precision to which the compressibility factor chart is valid. Several investigators have prepared such charts, a typical example of which is illustrated in Figure 10.8. The values of  $T_r$ , and  $P_r$  can be calculated from the critical constants



**Figure 10.8.** Fugacity coefficients of gases. By permission, from B. W. Gamson and K. M. Watson, *Natl. Petrol. News, Tech. Sec.* **36**, R623 (1944).

of the gas (Table 5.3),  $\gamma$  can be read from the chart, and the fugacity can be calculated from the expression

$$f = \gamma P \quad (10.57)$$

### Analytical Methods

**Based on the Virial Equation.** If the pressure–volume behavior of a gas is represented by a virial equation of the form [Equation (5.59)]

$$PV_m = RT + BP + CP^2 + \dots$$

Equation (10.34) becomes

$$\begin{aligned} \ln(f/P) &= (1/RT) \int_0^P (B + CP + \dots) dP \\ &= (1/RT)(BP + CP^2/2 + \dots) \end{aligned} \quad (10.58)$$

and the fugacity can be evaluated at any pressure from values of the virial coefficients. The limiting value of  $\alpha$  at zero pressure can be observed to be equal to the value of  $-B$ , where  $B$  is the second virial coefficient. (See Equation 5.6.)

**Based on the Redlich–Kwong Equation of State.** We can integrate  $d \ln(f/P)$  by using an equation of state such as the Redlich–Kwong equation. Integrating as in Equation (10.45), we obtain

$$\begin{aligned} RT \ln \frac{f}{P} &= - \int_0^P \alpha dP = \int_0^P \left( V_m - \frac{RT}{P} \right) dP \\ &= \int_0^P V_m dP - \int_0^P RT d \ln PX \end{aligned} \quad (10.59)$$

To evaluate the first integral, it is necessary to substitute for  $V_m$  or  $dP$ . A trial will show that it is simpler to substitute for  $dP$ . Thus, solving the Redlich–Kwong equation of state for  $P$ , we obtain

$$P = \frac{RT}{V_m - b} - \frac{a}{T^{1/2} V_m (V_m + b)} \quad (10.60)$$

and

$$dP = - \frac{RT}{(V_m - b)^2} dV_m + \frac{a}{T^{1/2} V_m (V_m + b)^2} dV_m + \frac{a}{T^{1/2} (V_m + b) V_m^2} dV_m \quad (10.61)$$

If we insert Equation (10.55) into Equation (10.53), we obtain

$$\begin{aligned}
 RT \ln \frac{f}{P} &= \int_{\infty}^{V_m} V_m \left[ -\frac{RT}{(V_m - b)^2} + \frac{a}{T^{1/2} V_m (V_m + b)^2} + \frac{a}{T^{1/2} (V_m + b) V_m^2} \right] dV_m \\
 &\quad - RT \ln P|_0^P \\
 &= - \int_{\infty}^{V_m} \frac{RT V_m}{(V_m - b)^2} dV_m + \int_{\infty}^{V_m} \frac{a}{T^{1/2} (V_m + b)^2} dV_m \\
 &\quad + \int_{\infty}^{V_m} \frac{a}{T^{1/2} V_m (V_m + b)} dV_m - RT \ln P|_0^P \\
 &= - \int_{\infty}^{V_m} \frac{RT(V_m - b + b)}{(V_m - b)^2} dV_m + \int_{\infty}^{V_m} \frac{a}{T^{1/2} (V_m + b)^2} dV_m \\
 &\quad + \int_{\infty}^{V_m} \frac{a}{T^{1/2} V_m (V_m + b)} dV_m - RT \ln P|_0^P \\
 &= - \int_{\infty}^{V_m} \frac{RT(V_m - b)}{(V_m - b)^2} dV_m - \int_{\infty}^{V_m} \frac{RTb}{(V_m - b)^2} dV_m \\
 &\quad + \int_{\infty}^{V_m} \frac{a}{T^{1/2} (V_m + b)^2} dV_m + \int_{\infty}^{V_m} \frac{a}{T^{1/2} V_m (V_m + b)} dV_m - RT \ln P|_0^P \\
 &= -RT \ln (V_m - b)|_{\infty}^{V_m} + \frac{RTb}{V_m - b} \Big|_{\infty}^{V_m} - \frac{a}{T^{1/2} (V_m + b)} \Big|_{\infty}^{V_m} \\
 &\quad + \frac{a}{T^{1/2} b} \ln \frac{V_m}{V_m + b} \Big|_{\infty}^{V_m} - RT \ln P|_0^P \tag{10.62}
 \end{aligned}$$

If we combine the first and fifth terms on the right side of Equation (10.56) before substituting limits, we obtain

$$\begin{aligned}
 RT \ln \frac{f}{P} &= -RT \ln \{P(V_m - b)\} \Big|_{P=0, V_m=\infty}^{P, V_m} + \frac{RTb}{V_m - b} \Big|_{\infty}^{V_m} \\
 &\quad - \frac{a}{T^{1/2} (V_m + b)} \Big|_{\infty}^{V_m} + \frac{a}{T^{1/2} b} \ln \frac{V_m}{V_m + b} \Big|_{\infty}^{V_m} \tag{10.63}
 \end{aligned}$$

As

$$\lim_{\substack{P \rightarrow 0 \\ V_m \rightarrow \infty}} P(V_m - b) = PV_m = RT \tag{10.64}$$

then

$$RT \ln \frac{f}{P} = -RT \ln \{P(V_m - b)\} + \frac{RTb}{V_m - b} - \frac{a}{T^{1/2}(V_m + b)} \\ + RT \ln RT + \frac{a}{T^{1/2}b} \ln \frac{V_m}{V_m + b} + 0 \quad (10.65)$$

Hence,

$$\ln \frac{f}{P} = \ln \frac{RT}{P(V_m - b)} + \frac{b}{V_m - b} - \frac{a}{RT^{3/2}(V_m + b)} + \frac{a}{RT^{3/2}b} \ln \frac{V_m}{V_m + b} \quad (10.66)$$

Thus, the fugacity of a gas that obeys the Redlich–Kwong equation can be evaluated from the constants  $a$  and  $b$  at any given pressure  $P$  and corresponding molar volume,  $V_m$ .

**An Approximate Method.** When the third virial coefficient is sufficiently small, it frequently happens that  $\alpha$  is roughly constant, particularly at relatively low pressures. A good example is hydrogen gas (Fig. 10.7). When this is the case, we can integrate Equation (10.51) analytically and obtain

$$RT \ln \frac{f}{P} = -\alpha P = BP \quad (10.67)$$

where  $B$  is the second virial coefficient, which is consistent with Equation (10.52) at low pressure.

This equation can be converted into several other approximate forms. For example,

$$\ln \frac{f}{P} = -\frac{\alpha P}{RT} = \frac{BP}{RT} \quad (10.68)$$

Therefore,

$$\frac{f}{P} = e^{-\alpha P/RT} = e^{BP/RT} \quad (10.69)$$

The exponential in Equation (10.69) can be expanded as a Taylor series to give

$$\frac{f}{P} = 1 - \frac{\alpha P}{RT} + \frac{1}{2!} \left(\frac{\alpha P}{RT}\right)^2 - \dots \\ = 1 + \frac{BP}{RT} + \frac{1}{2!} \left(\frac{BP}{RT}\right)^2 + \dots \quad (10.70)$$

If  $\alpha P \ll RT$ , we can neglect all terms of higher power than  $(\alpha P)$  and we can obtain

$$\frac{f}{P} = 1 - \frac{\alpha P}{RT} = \frac{RT - [(RT/P) - V_m]P}{RT} \\ = \frac{PV_m}{RT} = Z \quad (10.71)$$

Another relationship can be obtained by defining an *ideal* pressure  $P_i$  as

$$P_i = \frac{RT}{V_m} \quad (10.72)$$

If we substitute from Equation (10.72) into Equation (10.71), we obtain

$$\frac{f}{P} = \frac{P}{P_i} \quad (10.73)$$

Thus, the fugacity can be estimated from the observed pressure,  $P$ , and the ideal pressure can be calculated from the observed volume. The error (6, p. 198) in Equation (10.73) is less than 1% for oxygen up to a pressure of 10 MPa. For carbon dioxide, the error is 1% at 2.5 MPa and 4% at 5 MPa [6]. If  $\alpha P \ll RT$ , the numeric value of  $f/P$  is relatively insensitive to variations in the value of  $\alpha$  as large as 30%.

## 10.4 JOULE–THOMSON EFFECT FOR A VAN DER WAALS GAS

Although the van der Waals equation is not the best of the semi-empirical equations for predicting quantitatively the  $PVT$  behavior of real gases, it does provide excellent qualitative predictions. We have pointed out that the temperature coefficient of the fugacity function is related to the Joule–Thomson coefficient  $\mu_{J,T}$ . Let us now use the van der Waals equation to calculate  $\mu_{J,T}$  from a fugacity equation. We will restrict our discussion to relatively low pressures.

### Approximate Value of $\alpha$ for a van der Waals Gas

From the van der Waals Equation (5.54)

$$\left(P + \frac{a}{V_m^2}\right)(V_m - b) = RT$$

we obtain

$$PV_m + \frac{a}{V_m} - Pb - \frac{ab}{V_m^2} = RT$$

and

$$V_m + \frac{a}{PV_m} - b - \frac{ab}{PV_m^2} = \frac{RT}{P}$$

so that

$$\alpha = \frac{RT}{P} - V_m = \frac{a}{PV_m} - b - \frac{ab}{PV_m^2} \quad (10.74)$$

When the pressure is low enough that

$$PV_m \cong RT$$



then

$$\alpha \cong \frac{a}{RT} - b - \frac{abP}{(RT)^2} \quad (10.75)$$

At low pressures,  $bP/RT \ll PV_m/RT \cong 1$ ; hence, the third term on the right in Equation (10.75) is negligible in comparison with the first term, and

$$\alpha = \frac{a}{RT} - b \quad (10.76)$$

### Fugacity at Low Pressures

According to Equation (10.46)

$$RT \ln \frac{f}{P} = - \int_0^P \alpha dP$$

If we substitute  $\alpha$  from Equation (10.75) into Equation (10.46), we obtain

$$\begin{aligned} RT \ln \frac{f}{P} &= - \int_0^P \frac{a}{RT} dP + \int_0^P b dP + \int_0^P \frac{abP}{(RT)^2} dP \\ &= - \frac{aP}{RT} + bP + \frac{abP^2}{2(RT)^2} \end{aligned}$$

and

$$\ln \frac{f}{P} = - \frac{aP}{(RT)^2} + \frac{bP}{RT} + \frac{abP^2}{2(RT)^3} \quad (10.76)$$

### Enthalpy of a van der Waals Gas

According to Equation (10.42)

$$\frac{H_m^* - H_m}{RT^2} = \left( \frac{\partial \ln f}{\partial T} \right)_P$$

Differentiating Equation (10.76) with respect to  $T$ , we obtain

$$\left( \frac{\partial \ln f / P}{\partial T} \right)_P = \left( \frac{\partial \ln f}{\partial T} \right)_P = \frac{H_m^* - H_m}{RT^2} = \frac{2aP}{R^2 T^3} - \frac{bP}{RT^2} - \frac{3}{2} - \frac{abP^2}{R^3 T^4} \quad (10.77)$$

or

$$H_m^* - H_m = \frac{2aP}{RT} - bP - \frac{3abP^2}{2R^2T^2} \quad (10.78)$$

### Joule–Thomson Coefficient

From Equation (10.45), we see that

$$\mu_{J.T.} = \frac{1}{C_{Pm}} \left[ \frac{\partial(H_m^* - H_m)}{\partial P} \right]_T$$

If we apply Equation (10.45) to Equation (10.78), we obtain

$$\mu_{J.T.} = \frac{1}{C_{Pm}} \left( \frac{2a}{RT} - b - \frac{3abP}{R^2T^2} \right) \quad (10.79)$$

and the more approximate result [starting with Equation (10.70) for  $\alpha$ ] is

$$\mu_{J.T.} = \frac{1}{C_{Pm}} \left( \frac{2a}{RT} - b \right) \quad (10.80)$$

As  $C_{Pm}$  is positive, the sign of the Joule–Thomson coefficient depends on the sign of the expression in parentheses in Equations (10.79) and (10.80). The expression in Equation (10.79) is a quadratic in  $T$ , and are two values of  $T$  exist at any value of  $P$  for which  $\mu_{J.T.} = 0$ . Thus, Equation (10.79) predicts two values of the Joule–Thomson inversion temperature  $T_i$  for any pressure low enough for Equation (10.75) to be a good approximation for  $\alpha$ . As we saw in Section (5.2) and Figure 5.8, this prediction fits, at least qualitatively, the experimental data for the Joule–Thomson experiment for  $N_2$  at low pressure.

At sufficiently high temperatures and low pressures, Equation (10.80) applies. This equation predicts a single value of  $T_i$  that is independent of pressure. It can be observed from Figure 5.7 that this clearly is an approximate relationship for the upper inversion temperature.

## 10.5 MIXTURES OF REAL GASES [7]

Now that we have obtained expressions for the fugacity of a real gas and its temperature and pressure coefficients, let us consider the application of the concept of fugacity to components of a mixture of real gases.

### Fugacity of a Component of a Gaseous Solution

The equation for the fugacity of component  $i$  of a mixture has the same form as Equation (10.29),

$$\mu_i = \mu_i^\circ + RT \ln(f_i/f^\circ) \quad (10.81)$$

in which  $\mu_i^\circ$  and  $f^\circ$  have the values of the pure component at the standard pressure. On the basis of this definition, the fugacity of a component of a gaseous mixture is equal to that of the pure gas in equilibrium with the mixture across a membrane permeable only to that component.

As the mixture approaches ideality as the total pressure approaches zero, Equation (10.81) should approach Equation (10.17). The second part of the definition of fugacity for a gaseous component, which is analogous to Equation (10.24), is

$$\lim_{P \rightarrow 0} \frac{f_i}{p_i} = 1 \quad (10.82)$$

in which  $p_i$  is the partial pressure of the component in the mixture, which is defined as  $p_i = X_i P$ .

The form of Equation (10.33) for a component of a solution is

$$\left( \frac{\partial \ln f_i}{\partial P} \right)_{T, X_i} = \frac{V_{mi}}{RT} \quad (10.83)$$

The integration of Equation (10.83) for a component of a mixture leads to a problem of nonconvergence at  $P = 0$ , just as for a single gas. To circumvent this difficulty, we shall consider the ratio of the fugacity to the partial pressure of a component, just as we considered the ratio of the fugacity to the pressure of a single gas.

By steps analogous to Equations (10.32) and (10.33), we can show that

$$\left[ \frac{\partial \ln(f_i/p_i)}{\partial P} \right]_{T, X_i} = \frac{V_{mi}}{RT} - \frac{1}{P} \quad (10.84)$$

If we integrate Equation (10.84) between  $P = 0$  and  $P$ , we obtain

$$\ln \frac{f_i}{p_i} - \ln \left( \frac{f_i}{p_i} \right)_{P=0} = \int_0^P \left( \frac{V_{mi}}{RT} - \frac{1}{P} \right) dP \quad (10.85)$$

From Equation (10.30), we can see that  $\ln(f_i/p_i)$  approaches zero as  $P$  approaches zero; thus,

$$\ln \frac{f_i}{p_i} = \int_0^P \left( \frac{V_{mi}}{RT} - \frac{1}{P} \right) dP \quad (10.86)$$

If sufficient data are available on the dependence of the volume of the mixture on composition and pressure, the fugacities of the components can be calculated by means of Equation (10.86).

### Approximate Rule for Solutions of Real Gases (6, p. 198, 226)

As the evaluation of Equation (10.86) requires a great deal of data, and as adequate data are available for only a few mixtures of gases, it is useful to have approximate relationships that can be used to estimate the fugacity of components in a solution of gases.

For many gaseous solutions, even if the gases are not ideal, the partial molar volumes of the components are equal to the molar volumes of the pure components at the same total pressure. The gases are said to obey Amagat's rule, and the volume change on mixing is zero. Under these conditions, the gaseous solution behaves ideally in the sense that it obeys the equation

$$f_i = X_i f_i^\bullet \quad (10.87)$$

which is called the Lewis and Randall rule. Lewis and Randall suggested that, even though the gases in the solution are not ideal, the mixture behaves as an ideal solution in that the fugacity of each component obeys Equation (10.87), in which  $f_i^\bullet$  is the fugacity of the pure gas at the same temperature and at the same total pressure  $P$  and  $X_i$  is the mole fraction of the particular component. Thus, the fugacity of a component can be estimated from the fugacity of the pure gas and from the composition of the mixture.

### Fugacity Coefficients in Gaseous Solutions

The *fugacity coefficient*  $\gamma_i$  of a constituent of a gaseous solution is defined by the expression

$$\gamma_i = \frac{f_i}{p_i} \quad (10.88)$$

To the level of approximation provided by the Lewis and Randall rule,  $\gamma_i$  is given by the equation

$$\begin{aligned} \gamma_i &= \frac{X_i f_i^\bullet}{p_i} \\ &= \frac{X_i f_i^\bullet}{X_i P} \\ &= \gamma_i^\bullet \end{aligned} \quad (10.89)$$

in which  $\gamma_i^\bullet$  is the fugacity coefficient of the pure constituent at the same pressure and temperature. Thus, the fugacity coefficients obtained from Figure 10.8 for a pure gas could be used to estimate the fugacity of a component in a mixture.

### Equilibrium Constant and Change in Gibbs Functions and Planck Functions for Reactions of Real Gases

For the reaction



we can show, by a procedure analogous to that used for ideal gases, that the standard change in the Gibbs function is related to the equilibrium constant in terms of fugacities by the equation

$$\Delta G_m^\circ = -RT \ln K_f \quad (10.91)$$

and the Planck function is related to the equilibrium constant by the relation

$$\Delta Y_m^\circ = R \ln K_f \quad (10.92)$$

In these equations,  $K_f$  is given by the ratio

$$K_f = \frac{(f_C/f^\circ)^c (f_D/f^\circ)^d}{(f_A/f^\circ)^a (f_B/f^\circ)^b} \quad (10.93)$$

and is the thermodynamic equilibrium constant  $K$ . To obtain  $\Delta G_m^\circ$  or  $\Delta Y_m^\circ$  from equilibrium data, it is necessary to calculate the equilibrium constant in terms of fugacities rather than in terms of partial pressures.

As  $f_i = \gamma_i p_i$  [Equation (10.88)],  $K$  also can be expressed as

$$\begin{aligned} K = K_f &= \frac{(p_C \gamma_C / P^\circ)^c (p_D \gamma_D / P^\circ)^d}{(p_A \gamma_A / P^\circ)^a (p_B \gamma_B / P^\circ)^b} \\ &= \left( \frac{\gamma_C^c \gamma_D^d}{\gamma_A^a \gamma_B^b} \right) \frac{(p_C / P^\circ)^c (p_D / P^\circ)^d}{(p_A / P^\circ)^a (p_B / P^\circ)^b} \end{aligned} \quad (10.94)$$

$$\begin{aligned} K &= \left( \frac{\gamma_C^{\circ c} \gamma_D^{\circ d}}{\gamma_A^{\circ a} \gamma_B^{\circ b}} \right) \frac{(p_C / P^\circ)^c (p_D / P^\circ)^d}{(p_A / P^\circ)^a (p_B / P^\circ)^b} \\ &= K_\gamma K_P \end{aligned} \quad (10.95)$$

in which  $K_P$  represents the partial pressure equilibrium constant and  $K_\gamma$  is the corresponding ratio of the fugacity coefficients for the respective pure gases at the specified *total* pressure. Approximate values of  $K_\gamma$  can be obtained from tables and graphs of fugacity coefficients of *pure* gases, as in Figure 10.8, and  $K$  can be calculated from tables of  $\Delta G_m^\circ$  by the methods described in Chapter 7.

Then,  $K_P$  can be obtained at any pressure at which the fugacities of the pure gases are available.

## EXERCISES

10.1. Consider a gas with the equation of state

$$PV_m = RT + BP \quad (10.96)$$

for which  $B$  is a small *negative* number.

- a. Draw a rough sketch of a graph of  $PV_m$  versus  $P$  for this gas. Include a dotted line for the corresponding graph of an ideal gas.
- b. Draw a dotted curve for a graph of  $V_m$  versus  $P$  for an ideal gas. On this same graph, draw a curve for  $V_m$  versus  $P$  for a gas with the equation of state given by Equation (10.96).
- c. As  $P$  approaches zero what happens to the two curves in the graph in (b)?
- d. Solve Equation (10.96) explicitly for  $V_m$ . What is the limit of  $V_m$  as  $P$  approaches zero?
- e. Solve Equation (10.96) explicitly for  $[V_m - (RT/P)]$ . What is the limit of the quantity in brackets as  $P$  approaches zero?
- f. Draw a graph of  $[V_m - (RT/P)]$  versus  $P$  for the gas with the equation of state given by Equation (10.96).

Derive the following:

- g. An expression for  $\ln f$ .
- h. An expression for  $\gamma$ .
- i. An expression for the Joule–Thomson enthalpy.
- j. An expression for the Joule–Thomson coefficient.

10.2. For helium  $B$  in the equation of state (10.96) is essentially constant and equals  $11.5 \text{ cm}^3 \text{ mol}^{-1}$  in the temperature range  $30^\circ\text{C}$  to  $90^\circ\text{C}$  [8]. Find explicit answers to questions (g–j) of Exercise 1 for He at 0.1 MPa and  $60^\circ\text{C}$ .

10.3. If the fugacity function is defined by Equation (10.81), show that for a solution of two components

$$X_1 \left( \frac{\partial \ln f_1}{\partial X_1} \right)_{P,T} = X_2 \left( \frac{\partial \ln f_2}{\partial X_2} \right)_{P,T} \quad (10.97)$$

10.4. For hydrogen at 250 K, Johnston and White [3] obtained the data given in Table 10.1.

- a. Find the fugacity of hydrogen at 5 MPa by numeric integration of  $\alpha$  as a function of  $P$ .
- b. Use Equation (10.66) to calculate the fugacity of hydrogen at 5 MPa on the basis of the Redlich–Kwong equation, and compare with the result of (a).

**TABLE 10.1. Pressure–Volume Properties of H<sub>2</sub>(g)**

$P/\text{MPa}$	$PV_m/RT$	$P/\text{MPa}$	$PV_m/RT$
0.1013	1.000674	3.0398	1.019832
0.2027	1.001308	4.0530	1.026410
0.5066	1.003258	5.0663	1.033139
1.0133	1.006572	6.0795	1.039818
2.0265	1.013202	7.0928	1.046691

*Hint:* Use Equation (5.59) to calculate  $a$  and  $b$ , with the values of the critical constants in Table 10.3.

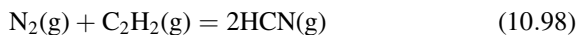
- 10.5.** Proceeding in a manner analogous to that used for ideal gases, derive the following equations for real gases:

$$\Delta G_m^\circ = -RT \ln K_f \quad (10.91)$$

and

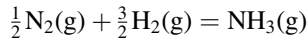
$$\Delta Y_m^\circ = R \ln K_f \quad (10.92)$$

- 10.6.** R. H. Ewell [9] suggested the following reaction as a method for the production of hydrogen cyanide:



- a. From data in the NIST WebBook [10] calculate  $\Delta G_m^\circ$  at 298 K for this reaction.
- b. By methods discussed previously, calculate  $\Delta G_m^\circ$  for this reaction at 300°C. The value obtained should be about 34,000 J mol<sup>-1</sup>. The necessary data can also be found in the WebBook [10].
- c. Calculate  $K_f$  for Reaction (10.98) at 300°C.
- d. Find the critical temperatures and pressures for the gases in Reaction (10.98) in Refs. [10], [11], and [12]. Tabulate these values. Also tabulate the reduced temperatures for 300°C and the reduced pressures for a total pressure of 0.5 MPa and 20.0 MPa.
- e. Referring to Figure 10.8, find  $\gamma$ 's for the gases in Reaction (10.98) at total pressures of 0.5 MPa and 20.0 MPa. Tabulate these values.
- f. Calculate  $K_\gamma$  at 0.5 MPa and 20.0 MPa, and add these values to the table in (e).
- g. Calculate  $K_P$  at 0.5 MPa and 20.0 MPa, and add these values to the table in (e).
- h. If we start with an equimolar mixture of N<sub>2</sub> and C<sub>2</sub>H<sub>2</sub>, what fraction of C<sub>2</sub>H<sub>2</sub> is converted to HCN at 0.5-MPa total pressure? At 20.0-MPa total pressure?

- i. What is the effect of increasing total pressure on the yield of hydrogen cyanide (HCN)?
- j. According to Le Chatelier's principle, what should be the effect of increasing total pressure on the yield of HCN?
- 10.7. The thermodynamic equilibrium constant  $K$  for the formation of ammonia according to the equation



is 0.0067 at 450°C.

- a. Calculate the degree of dissociation of ammonia at 450°C and 30.40-MPa total pressure. At this temperature and pressure, the fugacities of the pure gases, in MPa, are  $\text{H}_2$ , 33.13;  $\text{N}_2$ , 34.65; and  $\text{NH}_3$ , 27.66. Assume the Lewis and Randall rule.
- b. Make a corresponding calculation assuming that the fugacity coefficients all are equal to unity.
- 10.8. Table 10.2 shows values of  $V_m$  for  $\text{O}_2$  at 300 K taken from Weber [13].
- a. Calculate  $\alpha$  as a function of  $P$  for  $\text{O}_2$  at 300 K, and draw a smooth curve from your calculated points. Fit your results to a cubic polynomial in  $P$ .
- b. Calculate  $f/P$  at several values of  $P$  with Equation (10.46), using the cubic polynomial in an analytical integration.
- c. Calculate  $f/P$  at the same values of  $P$  with Equation (10.65), which is based on the assumption that  $\alpha$  is constant.
- d. Why do the values in (c) agree with the values in (b) for  $P \ll 10.000$  MPa, despite the clear variation of  $\alpha$  of 25% between 0 and 10 MPa? *Hint:* Consider the numeric properties of the  $\ln$  function and its argument when the argument is less than 1.
- 10.9. Pelekh and Carr [14] measured the value of  $K_P$  for the reaction

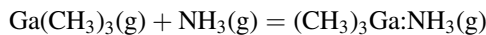


TABLE 10.2. Pressure–Volume Properties of  $\text{O}_2(\text{g})$

$P/\text{MPa}$	$V_m/\text{cm}^3 \text{ mol}^{-1}$
0.101325	24602.02
1.00000	2478.85
5.0000	484.94
10.000	237.81
20.000	118.38
30.00	82.28



**TABLE 10.3.**  $K_p$  as  $f(t^\circ\text{C})$  for Reaction of Ga ( $\text{CH}_3$ )<sub>2</sub> and  $\text{NH}_3$ 

$t/^\circ\text{C}$	$K_p/\text{atm}^{-1}$
40	$1.5 \pm 0.5 \times 10^4$
50	$6.5 \pm 1.6 \times 10^3$
60	$3.1 \pm 0.7 \times 10^3$
70	$1.6 \pm 0.4 \times 10^3$
80	$8.8 \pm 2.5 \times 10^2$
90	$5.1 \pm 1.6 \times 10^2$
100	$3.1 \pm 0.8 \times 10^2$

from measurements of total pressure, assuming that all reactants and products are ideal gases, making corrections for the dissociation to form  $\text{CH}_4(\text{g})$ . Table 10.3 shows their calculated values of  $K_p$  at seven temperatures from  $40^\circ\text{C}$  to  $100^\circ\text{C}$ .

- Calculate  $\Delta G_m^\circ$  for the reaction at each temperature.
- Plot  $\ln K$  against  $1/T$ , and determine whether the graph is linear by fitting to both a linear function and a quadratic.
- If the function is linear, calculate  $\Delta H_m^\circ$  from the slope of the line. If the function is not linear, calculate  $\Delta H_m^\circ$  at each temperature from the slope at each temperature.
- Calculate  $\Delta S_m^\circ$  at each temperature.

## REFERENCES

- R. M. Rosenberg and I. M. Klotz, *J. Chem. Educ.* **76**, 1448 (1999).
- H. S. Harned and R. W. Ehlers, *J. Am. Chem. Soc.* **55**, 652 (1933).
- Data for Figure 10.7 from H. L. Johnston and D. White, *Trans. Am. Soc. Mech. Eng.* **72**, 785 (1950).
- J. H. Dymond and E. B. Smith, *The Virial Coefficients of Gases*, Clarendon Press, Oxford, UK, 1969, 57.
- Values of  $\gamma$  for specific gases are available in *TRC Thermodynamic Tables-Hydrocarbons*, and *TRC Thermodynamic Tables-Non-Hydrocarbons*, Thermodynamics Research Center, The Texas A&M University System, College Station, TX. See <http://trcweb.tamu.edu/catalog>.
- G. N. Lewis and M. Randall, *Thermodynamics*, McGraw-Hill, New York, 1923, p. 198.
- More detailed treatments of the thermodynamic properties of gaseous solutions have been described by J. A. Beattie, *Chem. Rev.* **44**, 141 (1949); O. Redlich and J. N. S. Kwong, *Chem. Rev.* **44**, 233 (1949); K. S. Pitzer and G. O. Hultgren, *J. Am. Chem. Soc.* **80**, 4793 (1958); C. M. Knobler, *Chem. Thermodynamics, A Specialist Periodical Report* **2**, 199 (1978). B. E. Poling, J. M. Prausnitz, and J. P. O'Connell, *The Properties of Gases and Liquids*, McGraw-Hill, New York, 2001.

8. T. L. Cottrell and R. A. Hamilton, *Trans. Faraday Soc.* **52**, 156 (1956); A. Michels and H. Wouters, *Physica* **8**, 923 (1941).
9. R. H. Ewell, *Ind. Eng. Chem.* **32**, 147 (1940).
10. *NIST WebBook*. <http://www.WebBook.nist.gov/chemistry>.
11. J. F. Mathews, *Chem. Rev.* **72**, 71 (1972).
12. A. P. Kudchaker, G. H. Alani, and B. J. Zwolinski, *Chem. Rev.* **68**, 659 (1968).
13. L. A. Weber, *J. Res. Natl. Bur. Std. (U.S.)* **74A**, 93 (1970).
14. A. Pelekh and R. W. Carr, *J. Phys. Chem. A* **105**, 4697 (2001).



## CHAPTER 11

---

# THE THIRD LAW OF THERMODYNAMICS

---

### 11.1 NEED FOR THE THIRD LAW

We can determine the spontaneity of a reaction from values of  $\Delta G$  or  $\Delta Y$ , as we showed in Chapter 7. From Equation (7.26), we have

$$\Delta G = \Delta H - T\Delta S$$

and from Equation (7.34) we have

$$\Delta Y = \Delta S - \frac{\Delta H}{T}$$

We can calculate  $\Delta H$  from thermal data alone, that is, from calorimetric measurements of enthalpies of reaction and heat capacities. It would be advantageous if we could also compute  $\Delta S$  from thermal data alone, for then we could calculate  $\Delta G$  or  $\Delta Y$  without using equilibrium data. The requirement of measurements for an equilibrium state or the need for a reversible reaction thus could be avoided. The thermal-data method would be of particular advantage for reactions for which  $\Delta G$  or  $\Delta Y$  is very large (either positive or negative) because equilibrium measurements are most difficult in these cases.

We saw in Chapter 4 that  $\Delta H$  for a reaction at any temperature can be calculated from a value at one temperature and from the values of the heat capacities of reactants and products in the temperature range of interest. Similarly,  $\Delta S$  can be calculated at

any temperature from the value at one temperature and from the appropriate heat capacity data. However, unlike  $\Delta H$ ,  $\Delta S$  cannot be calculated from thermal data alone (that is, without obtaining equilibrium data) on the basis of the first and second laws. For that, we require another postulate, the *third law*.

## 11.2 FORMULATION OF THE THIRD LAW

We have pointed out previously that for many reactions the contribution of the  $T\Delta S$  term in Equation (7.26) is relatively small; thus,  $\Delta G$  and  $\Delta H$  frequently are close in value even at relatively high temperatures. In a comprehensive series of experiments on galvanic cells, Richards [1] showed that as the temperature decreases,  $\Delta G$  approaches  $\Delta H$  more closely, in the manner indicated in Figure 11.1 or Figure 11.2. Although these results were only fragmentary evidence, especially since they required extrapolation from 273 K to 0 K, they did furnish the clues that led Nernst to the first formulation of the third law of thermodynamics.

### Nernst Heat Theorem

The trend of  $\Delta G$  toward  $\Delta H$  can be expressed as

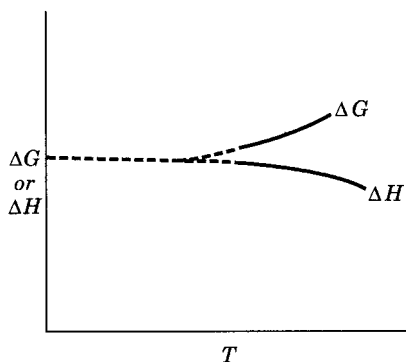
$$\lim_{T \rightarrow 0} (\Delta G - \Delta H) = 0 \quad (11.1)$$

Equation (11.1) is a consequence of Equation (7.26),

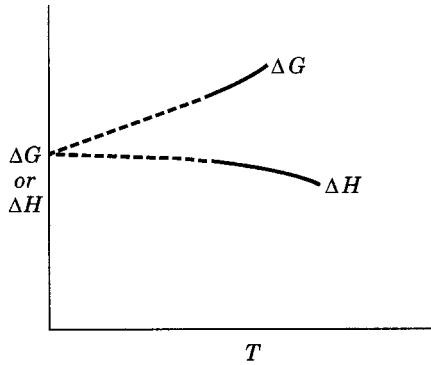
$$\Delta G = \Delta H - T\Delta S$$

because

$$\lim_{T \rightarrow 0} (-T\Delta S) = 0 \quad (11.2)$$



**Figure 11.1.** Limiting approach of  $\Delta G$  and  $\Delta H$  as  $T$  approaches 0. [Adapted from Richards [1].]



**Figure 11.2.** Alternative limiting approach of  $\Delta G$  and  $\Delta H$  as  $T$  approaches 0. [Adapted from Richards [1].]

without regard to the limit of  $\Delta S$  as long as  $\Delta S$  is finite. However, Nernst made the additional assumption, based on the appearance of some of Richards's curves (Fig. 11.1), that the limiting value of  $\Delta S$  is zero for all condensed systems:

$$\lim_{T \rightarrow 0} (-\Delta S) = \lim_{T \rightarrow 0} \left( \frac{\partial \Delta G}{\partial T} \right)_p = 0 \quad (11.3)$$

This assumption states not only that  $\Delta G$  approaches  $\Delta H$  as  $T$  approaches 0 K but also that the  $\Delta G$  curve and the  $\Delta H$  curve (Fig. 11.1) approach a horizontal limiting tangent.

Nernst asserted his postulate although the available data were inconclusive. In fact, Richards extrapolated some of his data to give a graph such as that shown in Figure 11.2, which suggests that Equation (11.1) is valid but that Equation (11.3) is not. Numerous subsequent experiments have confirmed Nernst's postulate if it is limited to perfect crystalline systems. *Apparent* exceptions have been accounted for satisfactorily. The term *perfect* implies a single, pure substance. Other restrictions are implied by this term, but they will be discussed later.

### Planck's Formulation

In Nernst's statement of the third law, no comment is made on the value of the entropy of a substance at 0 K, although it follows from his hypothesis that all pure crystalline substances must have the same entropy at 0 K. Planck [2] extended Nernst's assumption by adding the postulate that *the value of the entropy of a pure solid or a pure liquid approaches zero at 0 K*:

$$\lim_{T \rightarrow 0} S = 0 \quad (11.4)$$

The assumption of any finite constant for the entropy of all pure solids and liquids at 0 K leads to Nernst's theorem [Equation (11.3)] for these substances.

Equation (11.4) provides a convenient value for that constant. Planck's statement asserts that  $S_{0\text{K}}$  is zero only for *pure solids and pure liquids*, whereas Nernst assumed that his theorem was applicable to *all condensed phases*, including solutions. According to Planck, solutions at 0 K have a positive entropy equal to the entropy of mixing. (The entropy of mixing is discussed in Chapters 10 and 14).

### Statement of Lewis and Randall

Lewis and Gibson [3] also emphasized the positive entropy of solutions at 0 K and pointed out that supercooled liquids, such as glasses, even when composed of a single element (such as sulfur), probably retain a positive entropy as the temperature approaches absolute zero. For these reasons Lewis and Randall [4] proposed the following statement of the third law of thermodynamics:

If the entropy of each element in some crystalline state be taken as zero at the absolute zero of temperature, every substance has a finite positive entropy, but at the absolute zero of temperature the entropy may become zero, and does so become in the case of perfect crystalline substances.

We will adopt this statement as the working form of the third law of thermodynamics. This statement is the most convenient formulation for making calculations of changes in the Gibbs function or the Planck function. Nevertheless, more elegant formulations have been suggested based on statistical thermodynamic theory [5].

The preceding statement of the third law has been formulated to exclude solutions and glasses from the class of substances that are assumed to have zero entropy at 0 K. Let us examine one example of each exclusion to see that this limitation is essential.

For the mixing process



the entropy change can be represented as

$$\Delta S_{m,0\text{K}} = S_{\text{solid soln}} - S_{m,\text{AgBr}} - S_{m,\text{AgCl}} \quad (11.6)$$

and can be computed from the experimentally known  $\Delta S_{298}$  for the same mixing reaction and from heat capacity data from near 0 K to 298 K for each of the three solids [6].

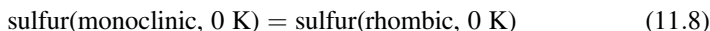
For the formation of one mole of this solid solution,  $\Delta S_{m,0\text{K}}$  is  $4.31\text{ J K}^{-1}\text{ mol}^{-1}$ . Hence, if  $S_{m,\text{AgBr}}$  and  $S_{m,\text{AgCl}}$  each are assigned zero at 0 K, the entropy of the solid solution at 0 K is not zero but  $4.31\text{ J K}^{-1}\text{ mol}^{-1}$ . This value is close to  $4.85\text{ J K}^{-1}\text{ mol}^{-1}$ , which is the value that would be calculated for the entropy of mixing to form an ideal solution.

Likewise, glasses do not have zero entropy at 0 K; that is,  $\Delta S_{m,0\text{K}}$  is not zero for a transition such as



To calculate  $\Delta S_m$  for this transition, it is necessary to have heat capacity data for both glassy and crystalline glycerol from near 0 K to the melting point and the heat of fusion of both glass and crystal. Such data [7] lead to a  $\Delta S_m$  for Equation (11.7) of  $19.2 \text{ J K}^{-1} \text{ mol}^{-1}$ . Thus, glassy glycerol cannot be assigned zero entropy at 0 K; rather, it possesses a residual entropy of  $19.2 \text{ J K}^{-1} \text{ mol}^{-1}$ .

Many substances can exist in two or more crystalline forms at low temperatures. Of course, one form is more stable than the others. Nevertheless, if each is a *perfect crystalline substance*, the entropy of each will be zero at 0 K. For example, for the transition



$\Delta S_{m,0K}$  can be computed from heat capacity measurements [8] for each crystalline form from near 0 K to the transition temperature (368.6 K) and the heat of transition. The result is zero within experimental error. Hence, both rhombic and monoclinic sulfur are assigned zero entropy at 0 K.

### 11.3 THERMODYNAMIC PROPERTIES AT ABSOLUTE ZERO

From the third law of thermodynamics, it is possible to derive several limiting relationships for the values of thermodynamic quantities at absolute zero for perfect crystalline substances.

#### Equivalence of $G$ and $H$

It follows from the definition of the Gibbs function, Equation (7.17), that

$$G_{0K} = H_{0K} - TS_{0K} = H_{0K} \quad (11.9)$$

#### $\Delta C_p$ in an Isothermal Chemical Reaction

From Equations (11.3) and (7.49), we can see that

$$\lim_{T \rightarrow 0} \left( \frac{\partial \Delta G}{\partial T} \right)_p = \lim_{T \rightarrow 0} (-\Delta S) = \lim_{T \rightarrow 0} \frac{\Delta G - \Delta H}{T} = 0 \quad (11.10)$$

As the left side of

$$\lim_{T \rightarrow 0} \frac{\Delta G - \Delta H}{1} = 0$$

is indeterminate because both  $(\Delta G - \Delta H)$  and  $T$  approach zero at 0 K, we can resolve this indeterminate expression by applying L'Hopital's rule of differentiating numerator and denominator, respectively, with respect to the independent variable  $T$ . Carrying out this procedure, from Equation (11.10), we obtain

$$\lim_{T \rightarrow 0} \frac{(\partial \Delta G / \partial T)_p - (\partial \Delta H / \partial T)_p}{T} = 0$$



and

$$\lim_{T \rightarrow 0} \left( \frac{\partial \Delta G}{\partial T} \right)_P = \lim_{T \rightarrow 0} \left( \frac{\partial \Delta H}{\partial T} \right)_P = \lim_{T \rightarrow 0} \Delta C_P \quad (11.11)$$

From Equation (11.3) and Equation (11.11), it follows that

$$\lim_{T \rightarrow 0} \Delta C_P = 0 \quad (11.12)$$

Many investigators have shown that  $\Delta C_P$  does approach zero as  $T$  approaches absolute zero. Nevertheless, these results in themselves do not constitute experimental evidence for the third law, which is a sufficient, but not a necessary, condition for Equation (11.12). If  $(\partial \Delta G / \partial T)_P$  is a nonzero, finite number, it can be shown by a series of equations corresponding to Equations (11.10) and (11.11) that Equation (11.12) is still valid.

### Limiting Values of $C_P$ and $C_V$

The third law asserts that the entropy of a substance (which is referred to the corresponding elements) must be finite or zero at absolute zero. In view of the finite values observed for  $\Delta S$  at higher temperatures, it follows that the entropy of a substance must be finite at all (finite) temperatures.

If we consider an entropy change at constant pressure, then from Equations (6.49) and (4.53),

$$dS_P = \frac{DQ_P}{T} = \frac{C_P dT}{T}$$

This differential equation can be integrated *at constant pressure* to give

$$S(T) = \int_0^T \frac{C_P dT}{T} + S(0 \text{ K}) \quad (11.14)$$

As  $S$  must be finite at all temperatures, it follows that

$$\lim_{T \rightarrow 0} C_P = 0 \quad (11.15)$$

If  $C_P$  had a finite value at  $T = 0$ , the integral in Equation (11.14) would not converge, because  $T$  in the denominator goes to zero and  $S$  would not be finite.

By an analogous procedure, we can show that

$$\lim_{T \rightarrow 0} C_V = 0 \quad (11.16)$$

### Temperature Derivatives of Pressure and Volume

From Equation (11.4)

$$\lim_{T \rightarrow 0} S = 0$$

It follows that in the limit of absolute zero, the entropy of a perfect crystalline substance must be independent of changes in pressure or volume (or any other variable of state except  $T$ ). Thus,

$$\lim_{T \rightarrow 0} \left( \frac{\partial S}{\partial P} \right)_T = 0 \quad (11.17)$$

and

$$\lim_{T \rightarrow 0} \left( \frac{\partial S}{\partial V} \right)_T = 0 \quad (11.18)$$

Applying Equation (7.59),

$$\left( \frac{\partial S}{\partial P} \right)_T = - \left( \frac{\partial V}{\partial T} \right)_P$$

to Equation (11.17), we obtain

$$\lim_{T \rightarrow 0} \left( \frac{\partial V}{\partial T} \right)_P = 0 \quad (11.19)$$

Similarly, from Equation (7.60),

$$\left( \frac{\partial S}{\partial V} \right)_T = \left( \frac{\partial P}{\partial T} \right)_V$$

and Equation (11.18) leads to

$$\lim_{T \rightarrow 0} \left( \frac{\partial P}{\partial T} \right)_V = 0 \quad (11.20)$$

In other words, the temperature gradients of the pressure and volume vanish as absolute zero is approached.

## 11.4 ENTROPIES AT 298 K

In the statement that we have adopted for the third law, it is assumed (arbitrarily) that the entropy of each element in some crystalline state is zero at 0 K. Then for every perfect crystalline substance, the entropy is also zero at 0 K. Consequently we can set  $S(0 \text{ K})$  in Equation (11.14) equal to zero. Thus, we may write

$$S(T) = \int_0^T \frac{C_p dT}{T} \quad (11.21)$$

and we can evaluate the entropy of a perfect crystalline solid at any specified temperature by integrating Equation (11.21). The molar entropy so obtained frequently is

called the “absolute” entropy and is indicated as  $S_{mT}^{\circ}$ . However, in no sense is  $S_{mT}^{\circ}$  truly an absolute entropy, because Equation (11.21) is based on the *convention* that zero entropy is assigned to each element in some state at 0 K. For example, this convention neglects any entropy associated with the nucleus, because no *changes* in nuclear entropy are expected under the conditions in which chemical reactions occur. Entropies obtained from Equation (11.21) properly are called *conventional* entropies or *standard* entropies.

To calculate the entropy of a substance at a temperature at which it is no longer a solid, it is necessary to add the entropy of transformation to a liquid or gas and the subsequent entropies of warming. The same procedure would apply to a solid that exists in different crystalline forms as the temperature is increased. The procedure can be illustrated by some sample calculations.

### Typical Calculations

**For Solid or Liquid.** For either of these final states, it is necessary to have heat capacity data for the solid down to temperatures approaching absolute zero.

The integration indicated by Equation (11.21) then is carried out in two steps. From approximately 20 K up, graphical or numerical methods can be used (see Appendix A). However, below 20 K, few data are available. Therefore, it is customary to rely on the Debye equation in this region.

*Use of Debye Equation at Very Low Temperatures.* Generally, it is assumed that the Debye equation expresses the behavior of the heat capacity adequately below about 20 K [9]. This relationship [Equation (4.68)],

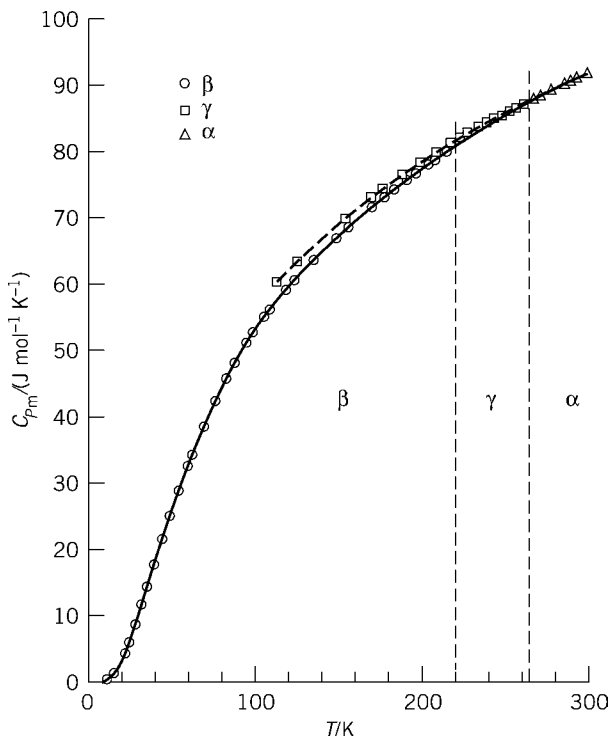
$$C_{Pm} \cong C_{Vm} = 1943.8 \frac{T^3}{\theta^3} \text{ J mol}^{-1} \text{ K}^{-1}$$

contains only one constant  $\theta$ , which can be determined from a value of  $C_{Pm}$  in the region below 20 K. The integral for the entropy then becomes

$$S_m = \int_0^T \frac{kT^3}{T} dT = \int_0^T kT^2 dT = \frac{kT^3}{3} = \frac{C_{Pm}(T)}{3} \quad (11.22)$$

in which  $k$  represents  $1943.8/\theta^3$ .

*Entropy of Methylammonium Chloride.* Heat capacities for this solid in its various crystalline modifications have been determined [10] precisely down to 12 K. Some of these data are summarized in Figure 11.3. There are three crystalline forms between 0 K and 298 K. One can calculate the entropy by integrating Equation (11.21) for each allotrope in the temperature region in which it is most



**Figure 11.3.** Heat capacities of the three allotropic forms,  $\alpha$ ,  $\beta$ , and  $\gamma$ , of methylammonium chloride [10]. The dashed curve represents the heat capacity of the metastable, supercooled  $\gamma$  form.

stable and then adding the two entropies of transition to the integrals thus obtained. The details at a pressure of 101.3 kPa are as follows:

Step 1.  $\text{CH}_3\text{NH}_3\text{Cl}(\text{s}, \beta \text{ form}, 0 \text{ K}) = \text{CH}_3\text{NH}_3\text{Cl}(\text{s}, \beta \text{ form}, 12.04 \text{ K})$

$$\Delta S_1 = \Delta S_{m1} = \int_{0 \text{ K}}^{12.04 \text{ K}} \frac{C_{Pm} dT}{T} = 0.280 \text{ J mol}^{-1} \text{ K}^{-1} \left( \begin{array}{l} \text{Debye equation} \\ \text{with } \Theta = 200.5 \text{ K} \end{array} \right)$$

Step 2.  $\text{CH}_3\text{NH}_3\text{Cl}(\text{s}, \beta \text{ form}, 12.04 \text{ K}) = \text{CH}_3\text{NH}_3\text{Cl}(\text{s}, \beta \text{ form}, 220.4 \text{ K})$

$$\Delta S_2 = \Delta S_{m2} = \int_{12.04 \text{ K}}^{220.4 \text{ K}} \frac{C_{Pm}}{T} dT = 93.412 \text{ J mol}^{-1} \text{ K}^{-1} \text{ (numerical integration)}$$

Step 3.  $\text{CH}_3\text{NH}_3\text{Cl}(\text{s}, \beta \text{ form}, 220.4 \text{ K}) = \text{CH}_3\text{NH}_3\text{Cl}(\text{s}, \gamma \text{ form}, 220.4 \text{ K})$

$$\Delta S_3 = \Delta S_{m3} = \frac{\Delta H_m}{T} = \frac{1779.0 \text{ J mol}^{-1}}{220.4 \text{ K}} = 8.072 \text{ J mol}^{-1} \text{ K}^{-1}$$

Step 4.  $\text{CH}_3\text{NH}_3\text{Cl}(\text{s}, \gamma \text{ form}, 220.4 \text{ K}) = \text{CH}_3\text{NH}_3\text{Cl}(\text{s}, \gamma \text{ form}, 264.5 \text{ K})$

$$\Delta S_4 = \Delta S_{m4} = \int_{220.4 \text{ K}}^{264.5 \text{ K}} \frac{C_{Pm} dT}{T} = 15.439 \text{ J mol}^{-1} \text{ K}^{-1} \text{ (numerical integration)}$$

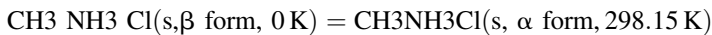
Step 5.  $\text{CH}_3\text{NH}_3\text{Cl}(\text{s}, \gamma \text{ form}, 264.5 \text{ K}) = \text{CH}_3\text{NH}_3\text{Cl}(\text{s}, \alpha \text{ form}, 264.5 \text{ K})$

$$\Delta S_5 = \Delta S_{m5} = \frac{\Delta H'_m}{T'} = \frac{2818.3 \text{ J mol}^{-1}}{264.5 \text{ K}} = 10.655 \text{ J mol}^{-1} \text{ K}^{-1}$$

Step 6.  $\text{CH}_3\text{NH}_3\text{Cl}(\text{s}, \alpha \text{ form}, 264.5 \text{ K}) = \text{CH}_3\text{NH}_3\text{Cl}(\text{s}, \alpha \text{ form}, 298.15 \text{ K})$

$$\Delta S_6 = \Delta S_{m6} = \int_{264.5 \text{ K}}^{298.15 \text{ K}} \frac{C_{Pm} dT}{T} = 10.690 \text{ J mol}^{-1} \text{ K}^{-1} \text{ (numerical integration)}$$

The addition of Steps 1 through 6 gives



and

$$\Delta S^\circ = \Delta S_m^\circ = \sum_1^6 \Delta S_{mi} = 138.548 \text{ J mol}^{-1} \text{ K}^{-1}$$

Thus, for methylammonium chloride,  $S_{m,298}^\circ$  is  $138.548 \text{ J mol}^{-1} \text{ K}^{-1}$ .

**For a Gas.** The procedure for the calculation of the entropy of a gas in its standard state is substantially the same as the that for a solid or liquid except for two factors. If the heat capacity data have been obtained at a pressure of 1 atm (101.325 kPa), the resultant value of  $S'_m$  is appropriate for that pressure and must be corrected to the standard state pressure of 1 bar (0.1 MPa). This correction is given by

the formula [11]

$$\begin{aligned} S_m^\circ(T) - S'_m(T) &= R \ln(P/P^\circ) \\ &= R \ln(101.325 \text{ kPa}/100 \text{ kPa}) \\ &= 0.1094 \text{ J mol}^{-1}\text{K}^{-1} \end{aligned} \quad (11.23)$$

In addition to the correction for the new standard state, it is necessary to correct for the transformation from the real gas at standard pressure to the ideal gas at standard pressure, which is defined as the standard state.<sup>1</sup>

*Entropy of Gaseous Cyclopropane at its Boiling Point.* Heat capacities for cyclopropane have been measured down to temperatures approaching absolute zero by Ruehrwein and Powell [12]. Their calculation of the entropy of the gas at the boiling point, 240.30 K, is summarized as follows:

Step 1.  $\text{C}_3\text{H}_6(\text{s}, 0 \text{ K}) = \text{C}_3\text{H}_6(\text{s}, 15 \text{ K})$

$$\Delta S_1 = \Delta S_{m1} = 1.017 \text{ J mol}^{-1}\text{K}^{-1} (\text{Debye equation with } \theta = 130 \text{ K})$$

Step 2.  $\text{C}_3\text{H}_6(\text{s}, 15 \text{ K}) = \text{C}_3\text{H}_6(\text{s}, 145.54 \text{ K})$

$$\Delta S_2 = \Delta S_{m2} = 65.827 \text{ J mol}^{-1}\text{K}^{-1} (\text{numerical integration})$$

Step 3.  $\text{C}_3\text{H}_6(\text{s}, 145.54 \text{ K}) = \text{C}_3\text{H}_6(\text{l}, 145.54 \text{ K})$

$$\Delta S_3 = \Delta S_{m3} = \frac{\Delta H_{m,\text{fusion}}}{T} = 37.401 \text{ J mol}^{-1}\text{K}^{-1}$$

Step 4.  $\text{C}_3\text{H}_6(\text{l}, 145.54 \text{ K}) = \text{C}_3\text{H}_6(\text{l}, 240.30 \text{ K})$

$$\Delta S_4 = \Delta S_{m4} = 38.392 \text{ J mol}^{-1}\text{K}^{-1} (\text{numerical integration})$$

Step 5.  $\text{C}_3\text{H}_6(\text{l}, 240.30 \text{ K}) = \text{C}_3\text{H}_6(\text{real gas}, 240.30 \text{ K})$

$$\Delta S_5 = \Delta S_{m5} = \frac{\Delta H_{m,\text{vap}}}{T} = 83.454 \text{ J mol}^{-1}\text{K}^{-1}$$

<sup>1</sup>The details of such a calculation can be found in the 5th Edition of this work, pp. 217–219.

Summing Steps 1–5, we obtain

$$\begin{aligned} \text{C}_3\text{H}_6(\text{s}, 0 \text{ K}) &= \text{C}_3\text{H}_6(\text{real gas}, 240.30 \text{ K}) \\ \Delta S &= \Delta S_{\text{m}} = \sum_1^5 \Delta S_{\text{m},i} = 226.10 \text{ J mol}^{-1} \text{ K}^{-1} \end{aligned}$$

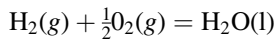
at a pressure of the real gas equal to 101.325 kPa. To correct the entropy of the real gas to a pressure of 0.1 MPa, we must add  $0.11 \text{ J mol}^{-1} \text{ K}^{-1}$  to the value above.

The correction for gas imperfection is equal to  $0.53 \text{ J mol}^{-1} \text{ K}^{-1}$ . Therefore, the entropy  $S_{\text{m},240,30}^{\circ}$  of cyclopropane in the ideal gas (that is, standard) state is  $226.74 \text{ J mol}^{-1} \text{ K}^{-1}$ .

The correction for gas imperfection may seem small. However, we should keep in mind that an error of  $-0.4 \text{ J K}^{-1} \text{ mol}^{-1}$  affects the free energy by about  $125 \text{ J mol}^{-1}$  near room temperature because  $\Delta S_{\text{m}}$  would be multiplied by  $T$ . An error of  $125 \text{ J mol}^{-1}$  would change an equilibrium constant of 1.00 to 1.05, which is a difference of 5%.

### Apparent Exceptions to the Third Law

Several cases exist in which calculations of the entropy change of a reaction from values of the entropy obtained from thermal data and the third law disagree with values calculated directly from measurements of  $\Delta H_{\text{m}}^{\circ}$  and determinations of  $\Delta G_{\text{m}}^{\circ}$  from experimental equilibrium constants. For example, for the reaction



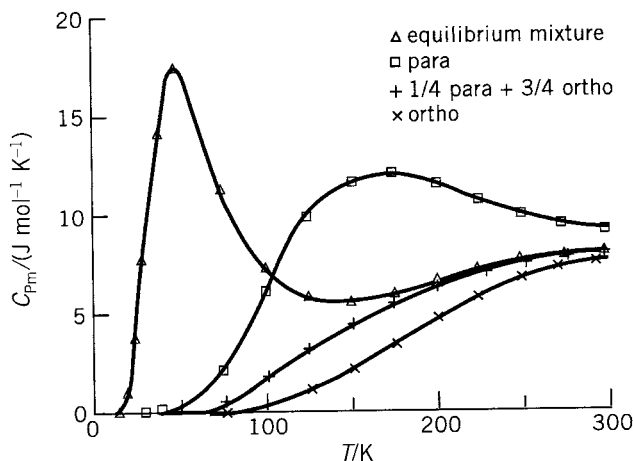
$$\Delta S_{\text{m}}^{\circ}(\text{thermal data}) = -153.6 \text{ J mol}^{-1} \text{ K}^{-1} \quad (11.24)$$

whereas

$$\Delta S_{\text{m}}^{\circ}(\text{equilibrium}) = \frac{\Delta H_{\text{m}}^{\circ} - \Delta G_{\text{m}}^{\circ}}{T} = -163.3 \text{ J mol}^{-1} \text{ K}^{-1} \quad (11.25)$$

Thus, a large discrepancy exists between the two entropy values.

A satisfactory explanation for this discrepancy was not available until the development of statistical thermodynamics with its methods of calculating entropies from spectroscopic data and the discovery of the existence of ortho- and parahydrogen. It then was found that the major portion of the deviation observed between Equations (11.24) and (11.25) is from the failure to obtain a true equilibrium between these two forms of  $\text{H}_2$  molecules (which differ in their nuclear spins) during thermal measurements at very low temperatures (Fig. 11.4). If true equilibrium were established at all times, more parahydrogen would be formed as the temperature is lowered, and at 0 K, all the hydrogen molecules would be in the



**Figure 11.4.** Heat capacities (excluding translation) for hydrogen ( $\text{H}_2$ ) gas as a function of temperature. Based on data of W. F. Giaque, *J. Am. Chem. Soc.* **52**, 4816 (1930).

para form and the entropy would be zero. In practice, measurements actually are made on a 3/1 mixture of ortho/para. This mixture at 0 K has a positive entropy. If the hydrogen were in contact with an appropriate catalyst for ortho–para conversion, an equilibrium mixture would be obtained, and the entropy could be calculated correctly from the integral that gives the area under a curve of  $C_{p,m}$  against  $T$  corresponding to the equilibrium curve in Figure 11.4.

When the corrections for ortho/parahydrogen are applied to Equation (11.24), the value obtained is  $-163.2 \text{ J mol}^{-1} \text{ K}^{-1}$ , which is in agreement with the equilibrium value. Most recent critical tables list  $S_{m,298}^\circ$  corrected for the effects discussed here.

With the development of statistical thermodynamics and the calculations of the entropies of many substances from spectroscopic data, several other substances in addition to hydrogen have been found to have values of molar entropies that disagree with those calculated from thermal data alone [13] (Table 11.1). The discrepancies can be accounted for on the assumption that even near absolute zero not all molecules are in the same state and that true equilibrium has not been attained. For CO,  $\text{COCl}_2$ ,  $\text{N}_2\text{O}$ , NO, and  $\text{ClO}_3\text{F}$ , the close similarity in the sizes of the atoms makes different

**TABLE 11.1. Molar Entropies**

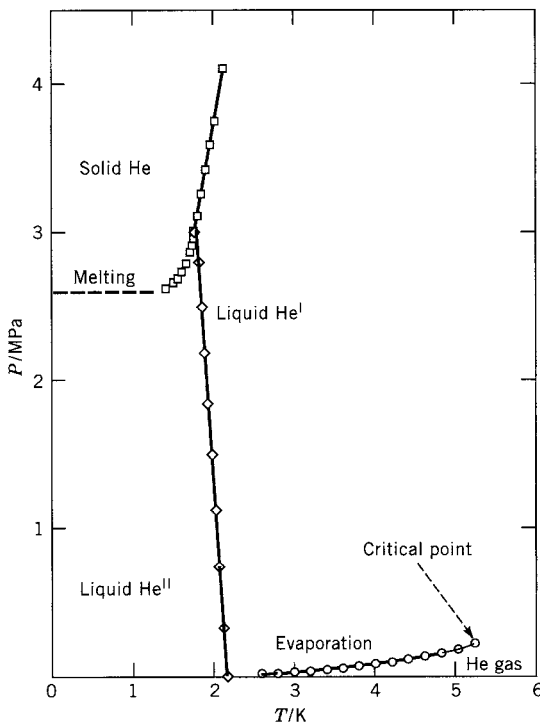
Substance	Temperature/ K	$S_m$ (spectroscopic)/ ( $\text{J mol}^{-1} \text{ K}^{-1}$ )	$S_m^\circ$ (calorimetric)/ ( $\text{J mol}^{-1} \text{ K}^{-1}$ )	Deviation/ ( $\text{J mol}^{-1} \text{ K}^{-1}$ )
CO	298.1	197.958	193.3	4.7
$\text{COCl}_2$	280.6	285.60	278.78	6.82
$\text{H}_2\text{O}$	298.1	188.70	185.27	3.43
$\text{N}_2\text{O}$	298.1	219.999	215.22	4.78
NO	121.4	183.05	179.9	3.2
$\text{ClO}_3\text{F}$	226.48	261.88	251.75	10.13



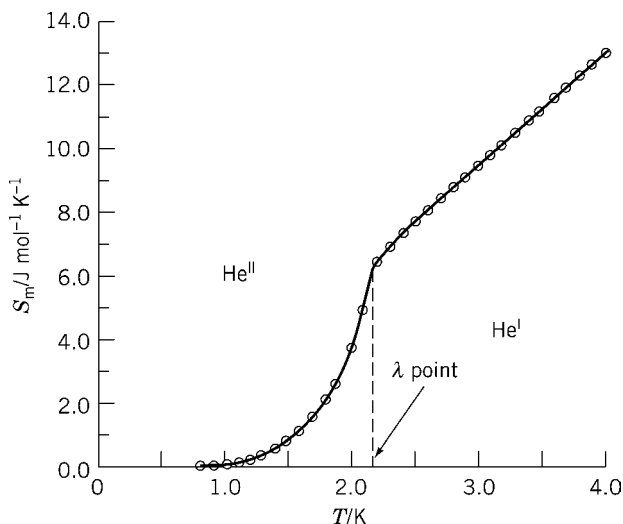
orientations possible in the crystals, whereas in the case of  $\text{H}_2\text{O}$ , hydrogen bonds maintain an irregularity in the distribution of molecules in the crystal. For example, in carbon monoxide, molecules may have random positions such as CO and OC in the crystal. Because of these exceptional situations, it is necessary to interpret the term *perfect crystal* as excluding situations in which several orientations of the molecules are present simultaneously.

Ulbrich and Waldbaum [14] pointed out that calorimetrically determined third law entropies for many geologically important minerals may be in error because site mixing among cations, magnetic spin disorder, and disorder among water molecules in the crystals is frozen in the samples used for calorimetric measurements. They have calculated corrections based on known crystallographic data for several minerals.

An exceptional case of a very different type is provided by helium [15], for which the third law is valid despite the fact that He remains a liquid at 0 K. A phase diagram for helium is shown in Figure 11.5. In this case, in contrast to other substances, the solid–liquid equilibrium line at high pressures does not continue downward at low pressures until it meets the liquid–vapor pressure curve to intersect at a triple point. Rather, the solid–liquid equilibrium line takes an unusual turn toward the horizontal as the temperature drops to near 2 K. This change is caused by a surprising



**Figure 11.5.** Phase diagram for  $^4\text{He}$ . Data for the melting curve and the  $\lambda$  line from C. A. Swenson, *Phys. Rev.* **79**, 626 (1950). Data for the evaporation curve from H. van Dijk and M. Durieux, *Physica* **24**, 920 (1958). The evaporation curve was measured down to 0.5 K, but the values of the vapor pressure were too small to be visible on the scale of the graph.



**Figure 11.6.** Entropy of liquid  $^4\text{He}$  under its equilibrium vapor pressure. Data below 1.90 K from H. C. Kramers, J. D. Wasscher, and C. J. Gorter, *Physica* **18**, 329 (1952). Data from 1.90 K to 4.00 K from R. W. Hill and O. V. Lounasmaa, *Phil. Mag. Ser. 8*, **2**, 143 (1957).

metamorphosis in the character of liquid helium as the temperature drops below 2.2 K. Below this temperature, the liquid has a heat conductivity 100 times greater than that of a metal such as copper or silver and becomes a superfluid in its flow behavior with a viscosity less than  $10^{-9}$  that of a liquid such as water.

This transformed liquid, labeled  $\text{He}^{\text{II}}$ , also shows unusual thermal properties. One of these properties, its entropy, is illustrated in Figure 11.6. An important feature of this curve is the approach of  $S_m$  to zero as  $T$  approaches 0. Thus, liquid  $\text{He}^{\text{II}}$  possesses zero entropy at 0 K despite being a liquid.

A confirmation of this conclusion also is provided by an examination of the solid–liquid equilibrium in the neighborhood of 0 K. As shown in Equation (8.9), a two-phase equilibrium obeys the Clapeyron equation:

$$\frac{dP}{dT} = \frac{S_{m,l} - S_{m,s}}{V_{m,l} - V_{m,s}}$$

The densities of liquid and solid helium are different; thus,  $\Delta V_m$  of Equation (8.9) is not zero. Yet the horizontal slope of the melting line of the phase diagram shows that  $dP/dT$  is zero near 0 K. Hence, it is clear that  $\Delta S_m$  of Equation (8.9) must be zero at 0 K, that is, that  $S_{m,0\text{K}}$  is zero for liquid He as well as for solid He.

The  $\lambda$  transition in liquid helium shown in Figures 11.5 and 11.6 is a second-order transition. Most phase transitions that follow the Clapeyron equation exhibit a nonzero value of  $\Delta S_m$  and  $\Delta V_m$ ; that is, they show a discontinuity in  $S_m$  and  $V_m$ , the first derivatives of the Gibbs free energy  $G_m$ . Thus, they are called *first-order transitions*. In contrast, the  $\lambda$  transition shows a zero value of  $\Delta S_m$  and  $\Delta V_m$  and exhibits discontinuities in the second derivatives of  $G_m$ , such as the heat capacity  $C_{Pm}$ .

## Tabulations of Entropy Values

Data on molar entropies are available from the following sources and online in the *NIST Chemistry WebBook* at <http://www.webbook.nist.gov/chemistry/>:

*International Critical Tables*, McGraw-Hill, New York, 1933.

Landolt-Börnstein, *Physikalisch-chemische Tabellen*, 5th ed., Springer, Berlin, 1936; 6th ed., 1961, 1963, 1967, 1972, 1980.

Landolt-Börnstein, *Zahlenwerte und Funktionen*, 6th ed., Springer-Verlag, Berlin, 1961, 1963, 1967, 1972.

Landolt-Börnstein, *Thermodynamic Properties of Inorganic Materials*, Vol. 19, Subvolume A1, *Pure Substances. Part 1: Elements and Compounds from AgBr to Ba<sub>3</sub>N<sub>2</sub>*, P. Franke and D. Neuschütz 1999, Guest eds., <http://www.springerlink.com/link.asp?id=KH6W2TX1RQ77>.

Subvolume A2, *Pure Substances. Part 2: Compounds from BeBr(g) to ZrCl<sub>2</sub>(g)*, 1999, <http://www.springerlink.com/link.asp?id=4EEKKY1F24PE>.

Subvolume A3, *Pure Substances. Part 3: Compounds from CoCl<sub>3</sub> to Ge<sub>3</sub>N<sub>4</sub>*, <http://www.springerlink.com/link.asp?id=NEGDT64X4YVX>.

Subvolume A4, *Pure Substances. Part 4: Compounds from HgH(g) to ZnTe(g)*. <http://www.springerlink.com/link.asp?id=92D3BEBCEG7H0>.

Subvolume B1, *Binary Systems. Part 1: Elements and Binary Systems from Ag-Al to Au-Tl*, P. Franke and D. Neuschütz, Guest eds., 2002, <http://www.springerlink.com/link.asp?id=B5BVPDD2PX27>.

Subvolume B2, *Thermodynamic Properties of Inorganic Materials: Binary systems. Part 2: Elements and Binary Systems from B-C to Cr-Zr*, 2004, <http://www.springerlink.com/link.asp?id=Q4AMK7NV6RFN>.

Subvolume B3, *Thermodynamic Properties of Inorganic Materials: Binary systems. Part 3: Binary Systems from Cs-K to Mg-Zr*, 2005, <http://www.springerlink.com/link.asp?id=N4NFQ36PTE6B>.

W. M. Latimer, *Oxidation Potentials*, 2nd ed., Prentice-Hall, Englewood Cliffs, NJ, 1952.

D. R. Stull and G. C. Sinke, *Thermodynamic Properties of the Elements*, American Chemical Society, Washington, DC, 1956.

K. K. Kelley, *U.S. Bur. Mines Bull.* 477 (1950); K. K. Kelley and E. G. King, *U.S. Bur. Mines Bull.*, 592 (1961).

NBS tables of chemical thermodynamic properties, *J. Phys. Chem. Ref. Data* **11**, Supplement No. 2 (1982).

R. Hultgren, P. D. Desai, D. T. Hawkins, M. Gleiser, K. K. Kelley, and D. D. Wagman, *Selected Values of Thermodynamic Properties of the Elements*, American Society of Metals, Metals Park, OH, 1973.

R. Hultgren, P. D. Desai, D. T. Hawkins, M. Gleiser, and K. K. Kelley, *Selected Values of the Thermodynamic Properties of Binary Alloys*, American Society for Metals, Metals Park, OH, 1973.

- R. A. Robie and B. S. Hemingway, Thermodynamic properties of minerals and related substances, *Geological Survey Bulletin 2131* (1995).
- M. Frenkel, K. N. Marsh, R. C. Wilhoit, G. J. Kabo, G. N. Roganov, *Thermodynamics of Organic Compounds in the Gas State*, Thermodynamics Research Center, College Station, TX, 1994.
- TRC Thermodynamic Tables-Hydrocarbons*, Thermodynamics Research Center: The Texas A & M University System, College Station, TX (Loose-leaf Data Sheets).
- TRC Thermodynamic Tables-Non-Hydrocarbons*, Thermodynamics Research Center: The Texas A & M University System, College Station, TX (Loose-leaf Data Sheets).
- M. W. Chase, Jr., NIST-JANAF Thermochemical Tables, 4th ed., *J. Phys. Chem. Ref. Data*, Monograph No. 9 (1998).
- E. S. Domalski, W. H. Evans, and E. D. Hearing, Heat capacities and entropies of organic compounds in the condensed phase, *J. Phys. Chem. Ref. Data* **13**, Supplement No. 1 (1984).
- J. D. Cox, D. D. Wagman, and V. A. Medvedev, *CODATA Key Values for Thermodynamics*, Hemisphere Publishing Corporation, New York, 1989.

A few typical values of molar entropies have been assembled in Tables 11.2 through 11.5, with a separate table for each database. Data obtained from spectroscopic studies have been included even though the methods used in their calculations have not been discussed here.

**TABLE 11.2. Standard Entropies at 298.15 K<sup>a</sup>**

Substance	$S_{m,298.15}^{\circ}/(\text{J mol}^{-1} \text{K}^{-1})$	Substance	$S_{m,298.15}^{\circ}/(\text{J mol}^{-1} \text{K}^{-1})$
H(g)	114.713	Methane(g)	186.264
O(g)	161.055	Ethane(g)	229.60
Cl(g)	165.198	Ethene(g)	219.56
Br(g)	175.022	Ethyne(g)	200.94
Br <sub>2</sub> (g)	245.463	Methanol(l)	126.8
I(g)	180.791	Ethanol(l)	160.7
I <sub>2</sub> (g)	260.69	Glycine(s)	103.51
H <sub>2</sub> O(g)	188.825	Acetic acid(l)	159.8
H <sub>2</sub> O(l)	69.91	Taurine(s)	154.0
HF(g)	173.779	Urea(s)	104.60
HCl(g)	186.908	SiO <sub>2</sub> (s); $\alpha$ quartz	41.84
HBr(g)	198.695	SiO <sub>2</sub> (s); $\alpha$ cristobalite	42.68
HI(g)	206.594	SiO <sub>2</sub> (s); $\alpha$ tridymite	43.5
ICl(g)	247.551	CaSO <sub>4</sub> (s); anhydrite	106.7
NO(g)	210.761	CaSO <sub>4</sub> ·2H <sub>2</sub> O; gypsum	194.1
CO(g)	197.674	Fe <sub>2</sub> SiO <sub>4</sub> (s); fayalite	145.2
CO <sub>2</sub> (g)	213.74	Mg <sub>2</sub> SiO <sub>4</sub> (s); forsterite	95.14
NH <sub>3</sub> (g)	192.45	SO <sub>2</sub> (g)	248.22
SO <sub>3</sub> (g)	256.76		

<sup>a</sup>NBS Tables of Chemical Thermodynamic Properties, *J. Phys. Chem. Ref. Data* **11**, Supplement No. 2 (1982).

**TABLE 11.3. Standard Entropies at 298.15 K<sup>a</sup>**

Substance	$S_{m,298.15}^{\circ}/$ (J mol <sup>-1</sup> K <sup>-1</sup> )	Substance	$S_{m,298.15}^{\circ}/$ (J mol <sup>-1</sup> K <sup>-1</sup> )
CO(g)	197.66	Propene(g)	266.73
CO <sub>2</sub> (g)	213.78	Propane(g)	270.31
Methane(g)	186.38	1-Butene(g)	307.86
Methanol(g)	239.88	Butane(g)	309.91
Ethyne(g)	200.92	Benzene(g)	269.30
Ethene(g)	219.25	Cyclohexane(g)	297.39
Acetic acid(g)	283.47	Toluene(g)	320.99
Ethane(g)	229.23	o-Xylene(g)	353.94
Ethanol(g)	280.64	m-Xylene(g)	386.65
		p-Xylene(g)	352.34

<sup>a</sup>M. Frenkel, K. N. Marsh, R. C. Wilhoit, G. J. Kabo, and G. N. Roganov, *Thermodynamics of Organic Compounds in the Gas State*, Thermodynamics Research Center, College Station, TX, 1994.

**TABLE 11.4. Standard Entropies at 298.15 K<sup>a</sup>**

Substance	$S_{m,298.15}^{\circ}/$ (J mol <sup>-1</sup> K <sup>-1</sup> )	Substance	$S_{m,298.15}^{\circ}/$ (J mol <sup>-1</sup> K <sup>-1</sup> )
Br <sub>2</sub> (g)	245.47 ± 0.05	CuSO <sub>4</sub> (s)	109.5 ± 0.6
I <sub>2</sub> (g)	260.69 ± 0.02	CuSO <sub>4</sub> · 5H <sub>2</sub> O(s)	301.2 ± 0.6
C(diamond)	2.38 ± 0.20	CaSO <sub>4</sub> · 2H <sub>2</sub> O(s)	193.8 ± 0.3
C(graphite)	5.74 ± 0.10	CaSO <sub>4</sub> (s)	107.4 ± 0.2
CO(g)	197.3 ± 0.0	CaSiO <sub>3</sub> (s)	81.7 ± 0.1
CO <sub>2</sub> (g)	213.8 ± 0.0	SiO <sub>2</sub> (s); α quartz	41.5 ± 0.1
NO <sub>2</sub> (g)	240.1 ± 0.1	SiO <sub>2</sub> (s); α cristobalite	43.4 ± 0.1
SO <sub>2</sub> (g)	248.2 ± 0.1	SiO <sub>2</sub> (s); α tridymite	43.9 ± 0.1
SO <sub>3</sub> (g)	256.8 ± 0.8	CH <sub>4</sub> (g)	186.26 ± 0.21
S(monoclinic)	33.03 ± 0.05	NH <sub>3</sub> (g)	192.77 ± 0.03
MgO(s)	26.9 ± 0.2	Fe <sub>2</sub> SiO <sub>4</sub> (s)	151.0 ± 0.2
Mg <sub>2</sub> SiO <sub>4</sub> (s)	91.4 ± 0.8		

<sup>a</sup>R. A. Robie and B. S. Hemingway, *Thermodynamic properties of minerals and related substances*, U.S. Geological Survey Bulletin 2131, 1995.

**TABLE 11.5. Standard Entropies at 298.15 K<sup>a</sup>**

Substance	$S_{m,298.15}^{\circ}/$ (J mol <sup>-1</sup> K <sup>-1</sup> )	Substance	$S_{m,298.15}^{\circ}/$ (J mol <sup>-1</sup> K <sup>-1</sup> )
HCl(g)	186.901	NH <sub>3</sub> (g)	192.774
HBr(g)	198.699	HF(g)	173.780
CO(g)	197.653	H <sub>2</sub> O(g)	188.834
CO <sub>2</sub> (g)	213.795		

<sup>a</sup>M. W. Chase, Jr., NIST-JANAF Thermochemical Tables, 4th ed., *J. Phys. Chem. Ref. Data*, Monograph No. 9 (1998).

## EXERCISES

11.1. Assuming that

$$\lim_{T \rightarrow 0} \left( \frac{\partial \Delta G}{\partial T} \right)_P = 0$$

for reactions involving perfect crystalline solids, prove that

$$\lim_{T \rightarrow 0} \left( \frac{\partial \Delta A}{\partial T} \right)_V = 0$$

11.2. Prove that  $\lim_{T \rightarrow 0} \Delta C_V = 0$ .

11.3. Assume that the limiting slope, as  $T$  approaches zero, of a graph of  $\Delta G$  versus  $T$  has a finite value but not zero. Prove that  $\Delta C_P$  for the reaction still would approach zero at 0 K.

11.4. Methylammonium chloride exists in several crystalline forms, as is evident from Figure 11.3. The thermodynamic properties of the  $\beta$  and  $\gamma$  forms have been investigated by Aston and Ziemer [10] down to temperatures near 0 K. Some of their data are listed below. From the information given, calculate the enthalpy of transition from the  $\beta$  to the  $\gamma$  form at 220.4 K.

$$C_{Pm} \text{ for } \beta \text{ at } 12.0 \text{ K} = 0.845 \text{ J mol}^{-1} \text{K}^{-1}$$

$$\int C_{Pm} d \ln T \text{ from } 12.0 \text{ K to } 220.4 \text{ K} = 93.412 \text{ J mol}^{-1} \text{K}^{-1}$$

$$C_{Pm} \text{ for } \gamma \text{ at } 19.5 \text{ K} = 5.966 \text{ J mol}^{-1} \text{K}^{-1}$$

$$\int C_{Pm} d \ln T \text{ from } 19.5 \text{ K to } 220.4 \text{ K} = 99.918 \text{ J mol}^{-1} \text{K}^{-1}$$

Transition temperature (that is, at  $P = 1 \text{ atm}$ ) = 220.4 K.

11.5. Cycloheptatriene has two different crystalline forms in the solid state. That labeled I undergoes an entropy change of  $116.223 \text{ J mol}^{-1} \text{K}^{-1}$  on being warmed from 0 K to 154 K [16]. Some thermal data for form II, the more stable one at very low temperatures, as well as for I are listed below. Is I a “perfect crystalline substance?”

$$C_{Pm} \text{ at } 12 \text{ K for II} = 4.52 \text{ J mol}^{-1} \text{K}^{-1}$$

$$\int C_{Pm} d \ln T \text{ from } 12 \text{ K to } 154 \text{ K for II} = 99.475 \text{ J mol}^{-1} \text{K}^{-1}$$

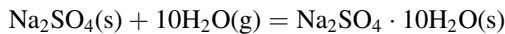
Transition temperature for(II = I) = 154 K

$$\Delta H_{\text{m of transition(II = I)}} = 2347 \text{ J mol}^{-1}$$

- 11.6.** The heat capacity of  $\text{Na}_2\text{SO}_4 \cdot 10\text{H}_2\text{O}$  has been measured from 15 K to 300 K [17] and  $S_{\text{m}298.15}^\circ$ , which was computed from

$$\int_{0 \text{ K}}^{298.15 \text{ K}} C_{P\text{m}} d \ln T$$

was found to be  $585.55 \text{ J mol K}^{-1}$ . The following thermodynamic data also are known for the hydration reaction:



$$\Delta G_{\text{m}298.15}^\circ = -91,190 \text{ J mol}^{-1}$$

$$\Delta H_{\text{m}298.15}^\circ = 521,950 \text{ J mol}^{-1}$$

Furthermore, the entropies  $S_{\text{m}298.15}^\circ$ , for anhydrous  $\text{Na}_2\text{SO}_4$  and for water vapor are  $149.49$  and  $188.715 \text{ J mol}^{-1} \text{ K}^{-1}$ , respectively. Is  $\text{Na}_2\text{SO}_4 \cdot 10\text{H}_2\text{O}$  a perfect crystal at 0 K?

- 11.7.** Two different crystalline forms of benzothiophene have been described [18]. The one that is the stable form at low temperatures is labeled I and the other II. Calorimetric measurements down to 12 K have been made with each crystalline form. At the normal transition temperature, 261.6 K, the molar enthalpy of transition (I = II) is  $3010 \text{ J mol}^{-1}$ . Some additional thermodynamic data obtained by these investigators are given in Table 11.6. Is Crystal II a perfect crystal at 0 K?
- 11.8.** We have observed that the limiting values at 0 K of  $\Delta G_{\text{m}}$  and  $\Delta H_{\text{m}}$  are equal and finite. What is the limiting value at 0 K of  $\Delta Y_{\text{m}}$ , the change in the molar Planck function?
- 11.9.** Putnam and Boerio-Gates [19] have measured the heat capacity of pure, crystalline sucrose from 4.99 K to above 298.15 K. Their smoothed results up to 298.15 K are shown in Table 11.7. Use the Debye equation and numerical integration of the experimental data to calculate  $S_{\text{m}}^\mu$  at 298.15 K.
- 11.10.** Boyer et al. [20] have measured the heat capacity of crystalline adenine, a compound of biologic importance, with high precision, from about 7 K to over 300 K, and calculated the standard entropy of adenine. Table 11.8 contains a sampling of their data over the range from 7.404 K to 298.15 K. Use those data to calculate the standard entropy of adenine at 298.15 K, which assume the Debye relationship for  $C_p$ . The value for 298.15 K is calculated by the authors from a function fitted to the original data.

**TABLE 11.6. Thermodynamic Data for Benzothiophene**

	Crystal I	Crystal II
$C_{Pm}$ at 12.4 K	4.469 J mol <sup>-1</sup> K <sup>-1</sup>	6.573 J mol <sup>-1</sup> K <sup>-1</sup>
$\int C_{Pm} d \ln T$ from 12 K to 261.6 K (numerical)	148.105 J mol <sup>-1</sup> K <sup>-1</sup>	152.732 J mol <sup>-1</sup> K <sup>-1</sup>
$\int C_{Pm} d \ln T$ from 261.6 K to 304.5 K (numerical)		23.142 J mol <sup>-1</sup> K <sup>-1</sup>
$\Delta H_m$ fusion (at 304.5 K)		11,827.3 J mol <sup>-1</sup>

**TABLE 11.7. Heat Capacities of Sucrose**

$T/K$	$C_{Pm}/R$	$T/K$	$C_{Pm}/R$
10	0.266	150	25.967
15	0.869	160	27.578
20	1.744	170	29.178
25	2.748	180	30.778
30	3.791	190	32.377
35	4.847	200	33.977
40	5.902	210	35.600
45	6.948	220	37.236
50	7.984	230	38.908
60	10.014	240	40.604
70	11.987	250	42.324
80	13.903	260	44.080
90	15.768	270	45.860
100	17.572	273.15	46.425
110	19.34	280	47.664
120	21.048	290	49.504
130	22.707	298.15	51.031
140	24.355		

**TABLE 11.8. Heat Capacity of Adenine**

$T/K$	$C_P/R$	$T/K$	$C_P/R$
7.404	0.04466	131.33	8.2000
12.893	0.3262	144.12	8.8371
20.226	0.8236	156.77	9.4619
29.190	1.6403	169.63	10.119
41.216	2.7915	182.32	10.784
54.069	3.8718	200.35	11.728
59.655	4.3117	226.01	13.113
68.949	4.942	251.72	14.539
81.405	5.6888	264.34	15.313
93.202	6.3430	279.79	16.112
106.13	6.9977	298.15	17.160
118.79	7.6214		



## REFERENCES

1. T. W. Richards, *Z. Physik. Chem.* **42**, 129 (1903).
2. M. Planck, *Thermodynamik*, 3rd ed., Veit & Co., Leipzig, 1911, p. 279; *Treatise on Thermodynamics*, 3rd ed., Dover Publications, New York, 1945, p. 274.
3. G. N. Lewis and G. E. Gibson, *J. Am. Chem. Soc.* **42**, 1529 (1920).
4. G. N. Lewis and M. Randall, *Thermodynamics*, McGraw-Hill New York, 1923, p. 448.
5. O. Stern, *Ann. Physik* **49**, 823 (1916); E. D. Eastman and R. T. Milner, *J. Chem. Phys.* **1**, 444 (1933); R. H. Fowler and E. A. Guggenheim, *Statistical Thermodynamics*, Macmillan, New York, 1939, p. 224; P. C. Cross and H. C. Eckstrom, *J. Chem. Phys.* **10**, 287 (1942); F. E. Simon, *Physica* **4**, 1089 (1937).
6. E. D. Eastman and R. T. Milner, *J. Chem. Phys.* **1**, 444 (1933).
7. F. Simon and E. Lange, *Z. Physik* **38**, 227 (1926).
8. E. D. Eastman and W. C. McGavock, *J. Am. Chem. Soc.* **59**, 145 (1937).
9. Deviations from the  $T^3$  law and their significance have been discussed by K. Clusius and L. Schachinger. *Z. Naturforschung* **2a**, 90 (1947); G. L. Pickard and R. E. Simon, *Proc. Phys. Soc.* **61**, 1 (1948); A. R. Ubbelohde, *Modern Thermodynamical Principles*, 2nd ed., Clarendon Press, Oxford, 1952, p. 109.
10. Reprinted with permission from J. G. Aston and C. W. Ziemer, *J. Am. Chem. Soc.* **68**, 1405 (1946). Copyright 1946 American Chemical Society.
11. NBS tables of chemical thermodynamic properties *J. Phys. Chem. Ref. Data* **11**, Supplement No. 2 (1982), 2–23.
12. R. A. Ruehrwein and T. M. Powell, *J. Am. Chem. Soc.* **68**, 1063 (1946).
13. W. F. Giauque and H. L. Johnston, *J. Am. Chem. Soc.* **50**, 3221 (1928); H. L. Johnston and W. F. Giauque, **51**, 3194 (1929); W. F. Giauque, **52**, 4816 (1930); J. O. Clayton and W. F. Giauque, **54**, 2610 (1932); W. F. Giauque and M. F. Ashley, *Phys. Rev.* **43**, 81 (1933); R. W. Blue and W. F. Giauque, *J. Am. Chem. Soc.* **57**, 991 (1935); W. F. Giauque and J. W. Stout, **58**, 1144 (1936); W. F. Giauque and W. M. Jones, **70**, 120 (1948); J. K. Koehler and W. F. Giauque, **80**, 2659 (1958); L. Pauling, *Phys. Rev.* **36**, 430 (1930); L. Pauling, *J. Am. Chem. Soc.* **57**, 2680 (1935).
14. H. H. Ulbrich and D. R. Waldbaum, *Geochim. Cosmochim. Acta* **40**, 1 (1976).
15. For an interesting discussion of the properties of helium at very low temperatures see K. Mendelssohn, *Science* **127**, 218 (1958); W. F. Vinen, *Endeavour* **25**, 3 (1966); K. Mendelssohn, *The Quest for Absolute Zero*, McGraw-Hill Book Co., New York, 1966.
16. H. L. Finke, D. W. Scott, M. E. Gross, J. F. Messerly, and G. Waddington, *J. Am. Chem. Soc.* **78**, 5469 (1956).
17. G. Brodale and W. F. Giauque, *J. Am. Chem. Soc.* **80**, 2042 (1958).
18. Reprinted with permission from H. L. Finke, M. E. Gross, J. F. Messerly, and G. Waddington, *J. Am. Chem. Soc.* **76**, 854 (1954). Copyright 1954 American Chemical Society.
19. R. L. Putnam and J. Boerio-Gates, *J. Chem. Thermodynamics* **25**, 607 (1993).
20. J. F. Boyer, M. R. Francis, and J. Boerio-Goates, *J. Chem. Thermodynamics* **35**, 1917 (2003).

## CHAPTER 12

---

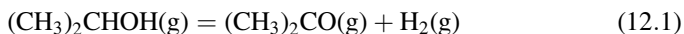
# APPLICATION OF THE GIBBS FUNCTION TO CHEMICAL CHANGES

---

Now that we have considered the calculation of entropy from thermal data, we can obtain values of the change in the Gibbs function for chemical reactions from thermal data alone as well as from equilibrium data. From this function, we can calculate equilibrium constants, as in Equations (10.22) and (10.90.). We shall also consider the results of statistical thermodynamic calculations, although the theory is beyond the scope of this work. We restrict our discussion to the Gibbs function since most chemical reactions are carried out at constant temperature and pressure.

### 12.1 DETERMINATION OF $\Delta G_m^\circ$ FROM EQUILIBRIUM MEASUREMENTS

The fundamental method of calculating  $\Delta G_m^\circ$  is from equilibrium measurements, primarily from measurement of the equilibrium constant of a chemical reaction. As an example, we shall consider the dissociation of isopropyl alcohol to form acetone and hydrogen:



With a suitable catalyst, equilibrium pressures can be measured for this dissociation.

If we start with  $n_0$  moles of isopropyl alcohol,  $\alpha n_0$  mole each of acetone and hydrogen are formed, where  $\alpha$  is the degree of dissociation. The quantity of

alcohol remaining at equilibrium must be  $(1 - \alpha)n_0$ . The total number of moles of all three gases is

$$n_{\text{total}} = (1 - \alpha)n_0 + \alpha n_0 + \alpha n_0 = (1 + \alpha)n_0 \quad (12.2)$$

If we assume that the gases in the equilibrium mixture are ideal,

$$n_{\text{total}} = \frac{PV}{RT} = n_0(1 + \alpha) \quad (12.3)$$

and  $\alpha$  can be calculated from knowledge of  $P$  and  $n_0$ . At 452.2 K and a total pressure  $P$  of 95.9 kPa.  $\alpha$  at equilibrium has been found [1] to be 0.564.

From Equation (12.1), the mole fraction  $X$  of each substance is

$$\begin{aligned} X_{(\text{CH}_3)_2\text{CHOH}} &= \frac{1 - \alpha}{1 + \alpha} \\ X_{(\text{CH}_3)_2\text{CO}} &= \frac{\alpha}{1 + \alpha} \\ X_{\text{H}_2} &= \frac{\alpha}{1 + \alpha} \end{aligned} \quad (12.4)$$

As the equilibrium constant  $K$  is determined from the equilibrium partial pressures [Equation (10.21)] it is given by

$$K = \frac{P_{(\text{CH}_3)_2\text{CO}}P_{\text{H}_2}}{P_{(\text{CH}_3)_2\text{CHOH}}P^\circ} = \frac{[\alpha/(1 + \alpha)]P[\alpha/(1 + \alpha)]P}{[(1 - \alpha)/(1 + \alpha)]P(P^\circ)} = \frac{\alpha^2}{1 - \alpha^2} \frac{P}{P^\circ} \quad (12.5)$$

and as  $\alpha = 0.564$  at 95.9 kPa

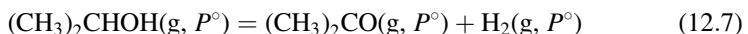
$$K = 0.450$$

The standard change in the Gibbs function then can be calculated from Equation (10.22).

$$\Delta G_{\text{m},452.2 \text{ K}}^\circ = -RT \ln (0.450) = 3000 \text{ J mol}^{-1} \quad (12.6)$$

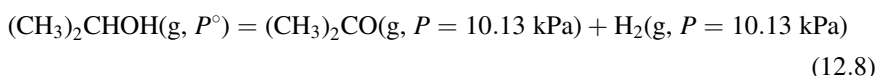
The values of  $\Delta G_{\text{m}}^\circ$  just calculated apply to a system in which all reactants and products are at standard pressure and which is sufficiently large that one mole of reaction does not alter the pressures appreciably. Alternatively, the expression  $R \ln K$  can be equated to  $(\partial G/\partial n)_{T,P}^\circ$  for a finite system, the initial rate of change of the total Gibbs function of the system per mole of reaction when all reactants and products are at standard pressure [2].

The positive value of  $\Delta G_{\text{m}}^\circ$  does not imply that the reaction under consideration may not proceed spontaneously under any conditions.  $\Delta G_{\text{m}}^\circ$  refers to the reaction



in which each substance is in its standard state, that is, at a partial pressure of 0.1 MPa. The positive value of  $\Delta G_m^\circ$  allows us to state categorically that Reaction (12.7) will not proceed spontaneously under these conditions. However, as in the experiment described, if we were to start with isopropyl alcohol at a partial pressure of 0.1 MPa and no acetone or hydrogen, the alcohol decomposes spontaneously at 452.2 K, and as the value of the equilibrium constant and the experimental data on which it is based indicate, more than 50% dissociation can occur in the presence of a suitable catalyst. Yields can be made even greater if one product is removed continuously.

We also can calculate  $\Delta G_m$  for one set of conditions with the substances not all in their standard states; for example,



For this computation, we refer to Equation (10.23), which relates  $\Delta G_m$  under any pressure conditions to  $\Delta G_m^\circ$  and the corresponding  $P$ 's and which, rearranged, is written as

$$\Delta G_m = \Delta G_m^\circ + RT \ln \frac{(P_C)^c (P_D)^d}{(P_A)^a (P_B)^b} P^{\circ(a+b-c-d)} \quad (12.9)$$

Applied to Equation (12.7) this relationship gives

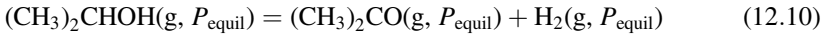
$$\begin{aligned} \Delta G_m &= 3000 \text{ J mol}^{-1} + RT \ln \frac{(10.13 \text{ kPa})^2}{(100 \text{ kPa})(100 \text{ kPa})} \\ &= -14,220 \text{ J mol}^{-1} \end{aligned}$$

Just as in the calculation of  $\Delta G_m^\circ$ , the value of  $\Delta G_m$  just calculated applies to a system large enough that the pressure given for reactant and product do not change when one mole of reaction occurs. Alternatively,  $\Delta G_m^\circ = RT \ln Q^*/K$  can be equated to  $(\partial G/\partial n)_{T,P}$  for a finite system, the instantaneous rate of change of the total free energy of the system per mole of reactants as the system composition passes through the designated pressures of reactants and products.

Thus, if we are considering a given reaction in connection with the preparation of some substance, it is important not to be misled by positive values of  $\Delta G_m^\circ$ , because  $\Delta G_m^\circ$  refers to the reaction under standard conditions. It is possible that appreciable yields can be obtained even though a reaction will not go to *completion*. Such a case is illustrated by the example of isopropyl alcohol, just cited. Only if  $\Delta G_m^\circ$  has very large positive values, perhaps more than 40 kJ, can we be assured, without calculations of the equilibrium constant, that no significant degree of transformation can be obtained. If we start with pure reactant, the initial value of  $(\partial G/\partial n)_{T,P}$  is always negative, because the pressures of products in the numerator of the logarithmic term in Equation (12.9) are equal to zero. As the reaction proceeds, the value of

$(\partial G/\partial n)_{T,P}$  becomes less negative and equals zero at equilibrium. How far the reaction proceeds before reaching equilibrium depends on the sign and magnitude of  $\Delta G_m^\circ$  [3].

The value of  $\Delta G_m^\circ$  is obtained by considering a reaction like that of Equation (12.7), in which reactants and products are in their standard states. Nevertheless, because  $\Delta G_m = 0$  at equilibrium, Equation (10.22) is used to calculate a value of the equilibrium constant  $K$  from  $\Delta G_m^\circ$ . In general, equilibrium states such as



are different from standard states. The equilibrium pressures can be calculated from  $K$  and thus from  $\Delta G_m^\circ$ . No unique values for the equilibrium pressures exist; rather, they depend on the initial pressures of the reactants and products.

## 12.2 DETERMINATION OF $\Delta G_m^\circ$ FROM MEASUREMENTS OF CELL POTENTIALS

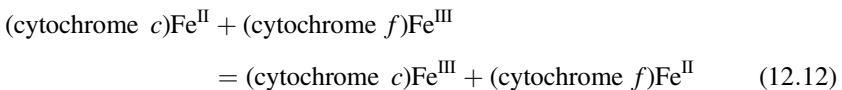
The method of determination from measurements of cell potentials depends on the possibility of carrying out a transformation *reversibly* in an electrical cell. (See Fig. 7.2.) In this case, the spontaneous tendency of the transformation will be opposed by an opposing potential just sufficient to balance the potential in the electrical cell produced by that spontaneous tendency. The potential observed under such circumstances is related to the change of the Gibbs function for the reaction by Equation (7.84)

$$\Delta G_m = -n\mathcal{F}\mathcal{E}$$

From Equation (7.80),  $\Delta G = W_{\text{net,rev}}$ , so that  $-n\mathcal{F}\mathcal{E}$  represents the net, reversible work per mole of reaction. From the appropriate extrapolation of measured values of  $\mathcal{E}$  (see Appendix A), a value of the standard potential  $\mathcal{E}^\circ$  can be obtained. The value of  $\mathcal{E}^\circ$  then can be used to calculate  $\Delta G_m^\circ$ :

$$\Delta G_m^\circ = -n\mathcal{F}\mathcal{E}^\circ \quad (12.11)$$

An example of a reaction to which this method is applicable is



Cytochrome *c* and cytochrome *f* both are involved in the electron transfer chain from glucose metabolites to molecular oxygen in aerobic organisms. From values of the half-cell potentials of cytochrome *c* and of cytochrome *f* at 30°C, it is possible to calculate that  $\mathcal{E}^\circ$  is 0.11 V for the reaction in Equation (12.12) [4]. Hence

$$\begin{aligned} \Delta G_m^\circ &= -(1)(96,487 \text{ C mol}^{-1})(0.11 \text{ V}) \\ &= -10,600 \text{ V C mol}^{-1} = -10,600 \text{ J mol}^{-1} \end{aligned}$$

### 12.3 CALCULATION OF $\Delta G_m^\circ$ FROM CALORIMETRIC MEASUREMENTS

We have observed from Equation (10.24) that we can calculate  $\Delta H_m$  from the temperature derivative of  $K$ , or we can calculate  $K$  at one temperature from the value of  $K$  at another temperature and the value of  $\Delta H_m$ . The technique of titration calorimetry [5] makes possible the calculation of  $K$  and  $\Delta H_m$  from the same experiment and, therefore,  $\Delta H_m$  and  $\Delta G_m$  and  $\Delta Y_m$ .

In a typical titration calorimetry experiment, a solution of a macromolecule  $M$  might be titrated with increments of a solution of a ligand  $X$ . The value of  $\Delta Q/\Delta[X]_{\text{tot}}$  is the parameter obtained for each increment of added ligand, which is a good approximation for  $dQ/d[X]_{\text{tot}}$ . As

$$dQ = \Delta H_m^\circ V_0 d[\text{MX}] \quad (12.13)$$

where  $\Delta H_m^\circ$  is the molar enthalpy of binding and  $V_0$  is the volume of the solution in the titration cell, then

$$\frac{dQ}{d[\text{MX}]} = \Delta H_m^\circ V_0 \quad (12.14)$$

and

$$\frac{dQ}{d[X]_{\text{tot}}} = \frac{dQ}{d[\text{MX}]} \frac{d[\text{MX}]}{d[X]_{\text{tot}}} = \Delta H_m^\circ V_0 \frac{d[\text{MX}]}{d[X]_{\text{tot}}} \quad (12.15)$$

We shall obtain an expression for  $\{d[\text{MX}]/(d[X]_{\text{tot}})\}$  from consideration of a reaction of 1:1 stoichiometry such as



in which  $M$  is being titrated with  $X$ . For this reaction, in solution, by analogy with Equation (10.21) for gases,

$$K = \frac{[\text{MX}]C^\circ}{[\text{M}][\text{X}]} \quad (12.17)$$

$$[X]_{\text{tot}} = [X] + [\text{MX}] \quad (12.18)$$

$$[M]_{\text{tot}} = [\text{MX}] + [M] = [\text{MX}] + \frac{[\text{MX}] C^\circ}{K[X]} \quad (12.19)$$

Equation (12.18) can be solved for  $[X]$ , and this result can be substituted into Equation (12.19) to give the quadratic equation

$$[\text{MX}]^2 + [\text{MX}] \left\{ -[M]_{\text{tot}} - [X]_{\text{tot}} - \frac{C^\circ}{K} \right\} + [X]_{\text{tot}} [M]_{\text{tot}} = 0 \quad (12.20)$$

The only physically meaningful root of Equation (12.20) is

$$[\text{MX}] = \frac{[\text{M}]_{\text{tot}} + [\text{X}]_{\text{tot}} + \frac{C^\circ}{K} - \left\{ \left( [\text{M}]_{\text{tot}} + [\text{X}]_{\text{tot}} + \frac{C^\circ}{K} \right)^2 - 4[\text{M}]_{\text{tot}}[\text{X}]_{\text{tot}} \right\}^{1/2}}{2} \quad (12.21)$$

Differentiation of Equation (12.21) with respect to  $[\text{X}]_{\text{tot}}$  gives

$$\frac{d[\text{MX}]}{d[\text{X}]_{\text{tot}}} = \frac{1}{2} \left[ 1 - \frac{-2[\text{M}]_{\text{tot}} + [\text{X}]_{\text{tot}} + \frac{C^\circ}{K}}{\left\{ \left( [\text{M}]_{\text{tot}} + [\text{X}]_{\text{tot}} + \frac{C^\circ}{K} \right)^2 - 4[\text{M}]_{\text{tot}}[\text{X}]_{\text{tot}} \right\}^{1/2}} \right] \quad (12.22)$$

From Equation (12.15)

$$\frac{dQ}{d[\text{X}]_{\text{tot}}} = \frac{dQ}{d[\text{MX}]} \frac{d[\text{MX}]}{d[\text{X}]_{\text{tot}}} = \Delta H_m^\circ V_0 \frac{d[\text{MX}]}{d[\text{X}]_{\text{tot}}} \quad (12.15)$$

so that

$$\frac{dQ}{d[\text{X}]_{\text{tot}}} = \frac{1}{2} \Delta H_m^\circ V_0 \left[ 1 - \frac{-2[\text{M}]_{\text{tot}} + [\text{X}]_{\text{tot}} + \frac{C^\circ}{K}}{\left\{ \left( [\text{M}]_{\text{tot}} + [\text{X}]_{\text{tot}} + \frac{C^\circ}{K} \right)^2 - 4[\text{M}]_{\text{tot}}[\text{X}]_{\text{tot}} \right\}^{1/2}} \right] \quad (12.23)$$

Thus, the left side of Equation (12.23) is the result of a titration calorimetry experiment, and the right-hand side includes experimental quantities and the equilibrium constant  $K$  and  $\Delta H_m^\circ$ . Therefore, the parameters  $\Delta H_m^\circ$  and  $K$  can both be obtained by a nonlinear, least-squares fitting of the data to the relation that we have derived (see Appendix A).

Once we have calculated  $K$  for a reaction, we can obtain values for  $\Delta G_m^\circ$  from Equation (10.22).

## 12.4 CALCULATION OF A GIBBS FUNCTION OF A REACTION FROM STANDARD GIBBS FUNCTION OF FORMATION

As the Gibbs function is a thermodynamic property, values of  $\Delta G$  do not depend on the intermediate chemical reactions that have been used to transform a set of reactants, under specified conditions, to a series of products. Thus, one can add known values of a Gibbs function to obtain values for reactions for which direct data are not available. The most convenient values to use are the functions for the formation of a compound in its standard state from the elements in their standard states, as given in Tables 7.2

through 7.5, and Equation (7.63) can then be used to calculate the Gibbs function or the Planck function for a desired reaction.

## 12.5 CALCULATION OF A STANDARD GIBBS FUNCTION FROM STANDARD ENTROPIES AND STANDARD ENTHALPIES

Now that we can calculate standard entropies from the third law (as in Chapter 11), let us consider their primary use, which is the calculations of the standard Gibbs function.

### Enthalpy Calculations

As we mentioned, it is necessary to have information about the standard enthalpy change for a reaction as well as the standard entropies of the reactants and products to calculate the change in Gibbs function. At some temperature  $T$ ,  $\Delta H_{mT}^\circ$  can be obtained from  $\Delta_f H_m^\circ$  of each of the substances involved in the transformation. Data on the standard enthalpies of formation are tabulated in either of two ways. One method is to list  $\Delta_f H_m^\circ$  at some convenient temperature, such as  $25^\circ\text{C}$ , or at a series of temperatures. Tables 4.2 through 4.5 contain values of  $\Delta_f H_m^\circ$  at 298.15 K. Values at temperatures not listed are calculated with the aid of heat capacity equations, whose coefficients are given in Table 4.8.

On the basis of statistical thermodynamics, another method of tabulation, using  $H_{mT}^\circ - H_{m0}^\circ$ , or  $(H_{mT}^\circ - H_{m0}^\circ)/T$ , or  $(H_{mT}^\circ - H_{m298.15}^\circ)/T$ , in which the subscripts refer to the Kelvin temperatures, has come into general use. This method of

**TABLE 12.1. Enthalpy Increment Function ( $H_{mT}^\circ - H_{m298.15}^\circ$ )<sup>a</sup>**

Substance	$\Delta_f H_{m298.15}^\circ / (\text{kJ mol}^{-1})$	$[(H_{mT}^\circ - H_{m298.15}^\circ)] / (\text{kJ mol}^{-1})$				
		400	600	800	1000	1500
CO(g)	-110.527	2.976	8.942	15.177	21.690	38.850
CO <sub>2</sub> (g)	-393.522	4.003	12.907	22.806	33.397	61.705
H <sub>2</sub> O(g)	-241.826	3.452	10.501	18.002	26.000	48.151
HBr(g)	-36.443	2.971	8.868	14.956	21.294	38.103
HCl(g)	-92.312	2.969	8.835	14.835	21.046	37.508
HF(g)	-272.546	2.968	8.804	14.677	20.644	36.239
NH <sub>3</sub> (g)	-45.898	3.781	12.188	21.853	32.637	63.582
H <sub>2</sub> (g)	0.0	2.959	8.811	14.702	20.680	36.290
N <sub>2</sub> (g)	0.0	2.971	8.894	15.046	21.463	38.405
F <sub>2</sub> (g)	0.0	3.277	10.116	17.277	24.622	43.458
Cl <sub>2</sub> (g)	0.0	3.533	10.736	18.108	25.565	44.422
C(graphite)	0.0	1.039	3.943	7.637	11.795	23.253
O <sub>2</sub> (g)	0.0	3.025	9.244	15.835	22.703	40.599

<sup>a</sup>M. W. Chase, Jr., NIST-JANAF thermochemical tables, 4th ed., *J. Phys. Chem. Ref. Data*, Monograph No. 9 (1995).



TABLE 12.2. Enthalpy Increment Function  $(H_{mT}^{\circ} - H_{m0}^{\circ})/T^a$ 

Substance	$\Delta_f H_{m0}^{\circ}/(\text{kJ mol}^{-1})$	$[(H_{mT}^{\circ} - H_{m0}^{\circ})/T]/(\text{J mol}^{-1}\text{K}^{-1})$					
		298.15 K	400 K	600 K	800 K	1000 K	1500 K
CO(g)	-113.8	29.11	29.12	29.37	29.81	30.36	31.68
CO <sub>2</sub> (g)	-393.1	31.41	33.42	37.12	40.21	42.76	47.37
Methane(g)	-66.6	33.59	34.72	38.65	43.52	48.49	59.53
Methanol(g)	-190.1	38.37	40.75	47.03	53.70	59.94	72.73
Ethyne(g)	228.8	33.57	37.09	42.89	47.38	51.04	58.11
Ethene(g)	61.0	35.28	38.51	46.43	54.21	61.18	75.05
Aceticacid(g)	-418.1	45.60	52.24	66.02	78.61	89.44	109.59
Ethane(g)	-68.2	39.83	44.68	55.72	66.53	76.36	96.09
Ethanol(g)	-217.4	47.80	54.26	67.99	80.64	91.64	112.97
Propene(g)	34.7	45.44	52.30	66.48	79.57	91.05	113.44
Propane(g)	-82.4	49.44	58.19	76.15	92.73	107.19	135.48
1-Butene(g)	20.4	57.43	67.53	87.87	106.29	122.22	152.93
<i>n</i> -Butane(g)	-97.2	64.60	76.61	100.42	121.96	140.67	176.82
Benzene(g)	100.4	47.73	60.60	86.56	108.99	127.50	161.24
Cyclohexane(g)	-83.8	58.85	76.18	113.36	147.99	177.76	
Toluene(g)	73.3	60.51	76.19	107.41	134.67	157.44	199.49
<i>o</i> -Xylene(g)	46.4	78.45	97.06	132.54	163.66	190.03	239.57
<i>m</i> -Xylene(g)	45.9	74.20	92.53	128.63	160.45	187.31	237.47
<i>p</i> -Xylene(g)	46.8	73.83	92.46	129.07	161.15	188.12	238.29
H <sub>2</sub> O(g)	-238.9	33.21	33.39	34.01	34.88	35.91	38.78
H <sub>2</sub> (g)	0.0	28.40	28.57	28.80	28.96	29.15	29.84
O <sub>2</sub> (g)	0.0	29.12	29.27	29.88	30.65	31.39	32.85
C(graphite) <sup>b</sup>	0.0	3.53	5.23	8.32	10.86	12.85	16.20

<sup>a</sup>M. Frenkel, K. N. Marsh, R. C. Wilhoit, G. J. Kabo, and G. N. Roganov, *Thermodynamics of Organic Compounds in the Gas State*, Thermodynamics Research Center, College Station, TX, 1994.

<sup>b</sup>Calculated from data in NIST-JANAF Thermochemical Tables; see Table 12.1.

presentation, which is illustrated in Tables 12.1 through 12.3, does not require the use of empirical heat capacity equations and allows easy comparison of data from different sources.

The following procedure is used to calculate  $\Delta_f H_m^{\circ}$  at any temperature  $T$  from Table 12.2. Data in Tables 12.1 and 12.3 are different only in the reference temperature. The standard enthalpy of formation of a compound C refers to the reaction



element in  
standard state  
at temperature  $T$

element in  
standard state  
at temperature  $T$

compound in  
standard state  
at temperature  $T$

TABLE 12.3. Enthalpy Increment Function ( $H_{mT}^{\circ} - H_{m298.15}^{\circ}$ )/ $T^a$ 

Substance	$\Delta_f H_{m298.15}^{\circ} /$ (J mol <sup>-1</sup> K <sup>-1</sup> )	$H_{m298}^{\circ} - H_{m0}^{\circ} /$ (J mol <sup>-1</sup> K <sup>-1</sup> )	$[(H_{mT}^{\circ} - H_{m298.15}^{\circ})/T]/(\text{J mol}^{-1}\text{K}^{-1})$				
			400 K	600 K	800 K	1000 K	1500 K
Graphite(c)	0.0	1.05	2.60	6.58	9.54	11.78	15.51
Diamond(c)	1.9	0.523	2.09	5.88	8.90	11.24	15.43
Cl <sub>2</sub> (g)	0.0	9.18	8.83	17.89	22.63	25.57	29.61
HCl(g)	-92.3	8.64	7.40	14.70	18.55	21.06	25.00
CaSO <sub>4</sub> (c)	-1434.4	17.30	27.87	60.83	80.98	95.52	
CuSO <sub>4</sub> (c)	-771.4	16.87	38.57	83.11	109.44	127.68	
Fe <sub>2</sub> SiO <sub>4</sub> (c)	-1478.2	22.49	36.51	78.23	102.16	118.39	
Mg <sub>2</sub> SiO <sub>4</sub> (c)	-2173.0	17.22	32.92	71.21	93.81	109.28	133.66
CaSiO <sub>3</sub> (c)	-1634.8	13.84	23.77	51.50	67.83	78.74	
Methane(g)	-74.8	10.025	9.52	21.74	30.80	38.16	51.98
NH <sub>3</sub> (g)	-45.9	10.045	9.43	20.28	27.31	32.65	42.37
CO(g)	-110.5	8.67	7.39	14.87	18.97	21.69	25.88
CO <sub>2</sub> (g)	-393.5	9.36	9.98	21.49	28.51	33.40	41.13
SiO <sub>2</sub> (c); quartz <sup>b</sup>	-910.7	9.616	12.52	28.18	38.58	45.52	53.96
SiO <sub>2</sub> (c); cristobalite <sup>c</sup>	-908.4	7.04	12.63	29.96	38.73	44.74	53.70
O <sub>2</sub> (g)	0.0	8.682	7.54	15.40	19.79	22.70	27.06
Cu(c) <sup>d</sup>	0.0	5.00	6.34	12.88	16.39	18.71	31.63
Ca(c) <sup>e</sup>	0.0	5.707	6.71	13.98	19.65	23.07	33.24
Fe(c) <sup>f</sup>	0.0	4.51	6.69	14.35	19.45	24.39	30.38
H <sub>2</sub> (g)	0.0	8.468	7.41	14.69	18.38	20.68	24.20
Mg(c) <sup>g</sup>	0.0	5.00	6.50	13.39	17.37	28.87	114.72
N <sub>2</sub> (g)	0.0	8.669	7.42	14.85	18.85	21.49	25.58
S(c) <sup>h</sup>	0.0	4.412	11.60	20.25	23.39	76.82	57.57
Si(c)	0.0	3.218	5.40	11.36	14.71	16.94	20.43

<sup>a</sup>R. A. Robie and B. S. Hemingway, Thermodynamic properties of minerals and related substances, *U.S. Geologic Survey Bulletin 2131*, 1995.

<sup>b</sup>Trigonal crystals to 844 K.  $\beta$ -crystals from 844 K.

<sup>c</sup>Tetragonal crystals to 523 K. Cubic crystals from 523 K.

<sup>d</sup>Melting point 1357.8 K.

<sup>e</sup> $\alpha$ -crystals to 716 K.  $\beta$ -crystals to melting point at 1115 K.

<sup>f</sup>Body-centered cubic to 1185 K. Curie point at 1043 K. Face-centered cubic from 1158 K to 1667 K. Body-centered cubic from 1667 K to melting point.

<sup>g</sup>Hexagonal close-packed crystals to melting point at 923 K. Boiling point at 1366.1 K.

<sup>h</sup>Orthombic crystals to 368.3 K. Monoclinic crystals from 368.3 K to melting point at 388.36 K. Liquid to fictive boiling point at 882.1 K.

The sum of the following equations gives the required  $\Delta_f H_m^{\circ}$  in terms of the functions  $(H_{mT}^{\circ} - H_{m0}^{\circ})/T$ :

$$A(0 \text{ K}) + B(0 \text{ K}) + \dots = C(0 \text{ K}), \Delta H = \Delta_f H_{m0}^{\circ} \quad (12.25)$$

$$A(T \text{ K}) = A(0 \text{ K}), \Delta H = \Delta H_m^{\circ} = (H_{m0}^{\circ} - H_{mT}^{\circ})_A \quad (12.26)$$

$$C(0 \text{ K}) = C(T \text{ K}), \Delta H = \Delta H_m^\circ = (H_{mT}^\circ - H_{m0}^\circ)_C \quad (12.27)$$

$$B(T \text{ K}) = B(0 \text{ K}), \Delta H = \Delta H_m^\circ = (H_{m0}^\circ - H_{mT}^\circ)_B \quad (12.28)$$

$$A(T \text{ K}) + B(T \text{ K}) + \cdots = C(T \text{ K})$$

$$\begin{aligned} \Delta_f H_{mT}^\circ &= \Delta H_{mT}^\circ = \Delta_f H_{m0}^\circ + (H_{mT}^\circ - H_{m0}^\circ)_{\text{compound}} \\ &\quad - \sum (H_{mT}^\circ - H_{m0}^\circ)_{\text{elements}} \end{aligned} \quad (12.29)$$

and

$$\begin{aligned} \Delta_f H_{mT}^\circ/T &= \Delta_f H_{m0}^\circ/T + (H_{mT}^\circ - H_{m0}^\circ)_{\text{compound}}/T \\ &\quad - \sum (H_{mT}^\circ - H_{m0}^\circ)_{\text{elements}}/T \end{aligned} \quad (12.30)$$

Each quantity in Equation (12.30) can be obtained from tables such as Table 12.2. The equations required for use with Tables 12.1 and 12.3 will be provided as an exercise at the end of the chapter.

### Entropy Calculations

Standard entropies for many substances are available in tables such as Tables 11.2 through 11.6. Generally, the values listed are for 298.15 K, but many of the original sources, such as the tables of the Thermodynamics Research Center, the JANAF tables, or the Geological Survey tables, give values for other temperatures also. If heat capacity data are available, entropy values for one temperature can be converted to those for another temperature by the methods discussed in Section 11.4.

In a reaction such as that represented by Equation (12.23), the standard entropy change  $\Delta S_{mT}^\circ$  at the temperature  $T$  is given by the expression

$$\Delta S_{mT}^\circ = S_{mT}^\circ(\text{compound}) - \sum S_{mT}^\circ(\text{elements}) \quad (12.31)$$

### Change in Standard Gibbs Function

When adequate enthalpy and entropy data are available, the calculation of  $\Delta G_{mT}^\circ$  is a matter of substitution into Equations (7.26).

$$\Delta G_{mT}^\circ = \Delta H_{mT}^\circ - T \Delta S_{mT}^\circ$$

Generally, data for  $\Delta H_m^\circ$  and  $\Delta S_m^\circ$  are available at least at one temperature. The conversion of the data for the Gibbs function from one temperature to another can be carried out by the methods outlined in Chapter 7.

Statistical thermodynamic methods and the use of spectroscopic information lead to the function  $(G_{mT}^\circ - H_{m0}^\circ)/T$ , and this function is tabulated in Table 12.4. Tables 12.5 and 12.6 give the alternative function  $(G_{mT}^\circ - H_{m298.15}^\circ)/T$ , which is equal to  $(Y_{mT}^\circ - Y_{m298.15}^\circ)$ . This method of tabulation avoids the use of empirical

TABLE 12.4. Gibbs Function Increment ( $G_{mT}^\circ - H_{m0}^\circ$ )/ $T^a$ 

Substance	[( $G_{mT}^\circ - H_{m0}^\circ$ )/ $T$ ]/(J mol <sup>-1</sup> K <sup>-1</sup> )					
	298.15 K	400 K	600 K	800 K	1000 K	1500 K
CO(g)	-168.55	-177.12	-188.96	-197.48	-204.21	-216.80
CO <sub>2</sub> (g)	-182.37	-191.88	-206.15	-217.26	-226.52	-244.80
Methane(g)	-152.79	-162.79	-177.56	-189.34	-199.56	-221.41
Methanol(g)	-201.51	-213.09	-230.76	-245.21	-257.87	-284.73
Ethyne(g)	-167.34	-177.70	-193.89	-206.87	-217.85	-239.96
Ethene(g)	-183.97	-194.76	-211.85	-226.29	-239.15	-266.74
Acetic acid(g)	-237.87	-252.18	-275.97	-296.72	-315.47	-355.84
Ethane(g)	-189.40	-201.78	-221.96	-239.47	-255.37	-290.33
Ethanol(g)	-232.85	-247.77	-272.37	-293.70	-312.91	-354.36
Propene(g)	-221.30	-235.59	-259.49	-280.44	-299.46	-340.89
Propane(g)	-220.87	-236.60	-263.62	-287.83	-310.15	-359.13
1-Butene(g)	-250.42	-268.69	-299.95	-327.81	-353.28	-409.04
<i>n</i> -Butane(g)	-245.31	-265.94	-301.54	-333.46	-362.75	-427.19
Benzene(g)	-221.56	-237.35	-252.30	-294.97	-321.35	-379.92
Cyclohexane(g)	-238.54	-258.19	-296.12	-333.57	-369.89	
Toluene(g)	-260.48	-280.42	-317.30	-352.04	-384.62	-457.01
<i>o</i> -Xylene(g)	-275.49	-311.03	-347.30	-389.81	-429.25	-516.35
<i>m</i> -Xylene(g)	-284.45	-308.68	-353.23	-394.71	-433.49	-519.62
<i>p</i> -Xylene(g)	-278.51	-302.67	-347.29	-388.94	-427.89	-514.36
H <sub>2</sub> O(g)	-155.12	-165.28	-178.93	-188.83	-196.72	-211.81
H <sub>2</sub> (g)	-102.28	-110.65	-122.28	-130.59	-137.07	-149.01
O <sub>2</sub> (g)	-176.02	-184.60	-196.57	-205.27	-212.19	-225.21
C(graphite) <sup>b</sup>	-2.216	-3.490	-6.209	-8.914	-11.611	-17.165

<sup>a</sup>M. Frenkel, K. N. Marsh, R. C. Wilhoit, G. J. Kabo, and G. N. Roganov, *Thermodynamics of Organic Compounds in the Gas State*, Thermodynamics Research Center, College Station, TX, 1994.

<sup>b</sup>Calculated from values in NIST-JANAF Thermochemical Tables; see Table 12.6.

equations, with their associated constants, and allows direct comparison of data from different sources. Although we will not discuss the methods for calculating this new function from experimental data by statistical thermodynamic methods, we will use tables of these functions to obtain the change in the Gibbs function for a reaction.

To calculate the Gibbs function for the formation of a compound C, we use Equations (12.32) through (12.36), which are analogous to the equations used to calculate  $\Delta_f H_m^\circ$ . In each case we use the relationship [Equation (11.9)] at 0 K

$$G_{m0}^\circ = H_{m0}^\circ$$

to obtain

$$A(0\text{ K}) + B(0\text{ K}) + \dots = C(0\text{ K}), \Delta G = \Delta_f G_{m0}^\circ = \Delta_f H_{m0}^\circ \quad (12.32)$$

$$C(0\text{ K}) = C(T), \Delta G = (G_{mT}^\circ - G_{m,0K}^\circ)_C = (G_{mT}^\circ - H_{m,0K}^\circ)_C \quad (12.33)$$

**TABLE 12.5. Gibbs Function Increment,  $-(G_{mT}^\circ - H_{m298.15}^\circ)/T^a$**

	$[-(G_{mT}^\circ - H_{m298.15}^\circ)/T]/(\text{J mol}^{-1} \text{ K}^{-1})$				
	400 K	600 K	800 K	1000 K	1500 K
C(graphite)	6.12	7.97	10.29	12.67	18.22
Carbon(diamond)	2.09	5.88	8.90	11.24	15.43
Cl <sub>2</sub> (g)	223.43	229.95	235.81	241.20	252.44
HCl(g)	188.04	192.61	197.41	201.84	211.20
CaSO <sub>4</sub> (c)	111.58	129.77	150.22	169.92	
CuSO <sub>4</sub> (c)	38.57	83.11	109.44	127.68	
Fe <sub>2</sub> SiO <sub>4</sub> (c)	156.48	180.09	206.13	230.77	
Mg <sub>2</sub> SiO <sub>4</sub> (c)	99.05	120.44	144.25	166.94	216.35
CaSiO <sub>3</sub>	85.26	100.71	117.94	134.32	
Methane(g)	187.70	194.03	201.58	209.27	227.53
NH <sub>3</sub> (g)	194.20	200.28	207.13	213.82	229.03
CO(g)	198.41	203.00	207.89	212.43	222.11
CO <sub>2</sub> (g)	215.30	221.75	228.96	235.88	251.04
SiO <sub>2</sub> (c); α quartz <sup>b</sup>	43.33	51.64	61.25	70.73	90.96
SiO <sub>2</sub> (c); α cristobalite <sup>c</sup>	45.31	54.64	64.55	73.87	93.91
O <sub>2</sub> (g)	206.31	211.04	216.12	220.86	230.99
N <sub>2</sub> (g)	192.75	197.35	202.22	206.73	216.30
H <sub>2</sub> (g)	131.82	136.40	141.18	145.54	154.66
Mg(c) <sup>d</sup>	33.66	37.76	42.20	47.11	67.49
Cu(c) <sup>e</sup>	34.11	38.08	42.31	46.23	55.58
Ca(c) <sup>f</sup>	43.93	48.17	52.99	57.75	70.13
Si(c)	19.63	23.08	26.84	30.38	37.98
Fe(c) <sup>g</sup>	28.10	32.41	37.27	42.11	53.67
S(c) <sup>h</sup>	33.19	39.82	46.14	58.59	85.56

<sup>a</sup>R. A. Robie and B. S. Hemingway, Thermodynamic properties of minerals and related substances, *U.S. Geologic Survey Bulletin 2131*, 1995.

<sup>b</sup>Trigonal crystals to 844 K. β-crystals from 844 K.

<sup>c</sup>Tetragonal crystals to 523 K. Cubic crystals from 523 K.

<sup>d</sup>Hexagonal close-packed crystals to melting point at 923 K. Boiling point at 1366.1 K.

<sup>e</sup>Melting point 1357.8 K.

<sup>f</sup>α-Crystals to 716 K. β-crystals to melting point at 1115 K. Body-centered cubic 1667 K to melting point.

<sup>g</sup>Body-centered cubic to 1185 K. Curie point at 1043 K. Face-centered cubic from 1158 K.

<sup>h</sup>Orthombic crystals to 368.3 K. Monoclinic crystals from 368.3 K to melting point at 388.36 K. Liquid to fictive boiling point at 882.1 K.

$$B(T) = B(0 \text{ K}), \Delta G = (G_{m,0K} - G_{m,T})_B = -(G_{m,T} - H_{m,0K})_B \quad (12.34)$$

$$A(T) = A(0 \text{ K}), \Delta G = (G_{m,0K} - G_{m,T})_A = -(G_{m,T} - H_{m,0K})_A \quad (12.35)$$

The summation of Equations (12.32) through (12.35) leads to the expression

$$\begin{aligned}
 A(T) + B(T) + \dots &= C(T), \\
 \Delta G_{m,T} &= \Delta_f H_{m,0}^\circ + (G_{m,T}^\circ - H_{m,0K}^\circ)_{\text{compound}} \\
 &\quad - \sum (G_{m,T}^\circ - H_{m,0K}^\circ)_{\text{elements}} \quad (12.36)
 \end{aligned}$$

TABLE 12.6. Gibbs Function Increment,  $-(G_{mT}^\circ - H_{m298.15}^\circ)/T^a$ 

Substance	$[-(G_{mT}^\circ - H_{m298.15}^\circ)/T]/(\text{J mol}^{-1} \text{K}^{-1})$				
	400 K	600 K	800 K	1000 K	1500 K
H <sub>2</sub> (g)	131.817	136.392	141.171	145.536	154.652
O <sub>2</sub> (g)	206.308	211.044	216.126	220.875	231.002
N <sub>2</sub> (g)	192.753	197.353	202.209	206.708	216.277
F <sub>2</sub> (g)	204.040	209.208	214.764	219.930	230.839
Br <sub>2</sub> (g)	246.818	252.575	258.618	264.143	275.595
C(graphite)	6.117	7.961	10.279	12.662	18.216
CO(g)	198.798	203.415	208.305	212.848	222.526
CO <sub>2</sub> (g)	215.307	221.772	228.986	235.901	251.062
H <sub>2</sub> O(g)	190.159	195.550	201.322	206.738	218.520
HBr(g)	199.843	204.437	209.270	213.737	223.228
HF(g)	174.923	179.501	184.273	188.631	197.733
NH <sub>3</sub> (g)	194.200	200.302	207.160	213.849	229.054
Cl <sub>2</sub> (g)	224.431	229.956	235.814	241.203	252.438
HCl(g)	188.045	192.469	197.434	201.857	211.214

<sup>a</sup> M. W. Chase, Jr., NIST-JANAF Thermochemical Tables, 4th ed., *J. Phys. Chem. Ref. Data*, Monograph No. 9 (1995).

To express the result in terms of the statistical thermodynamic expression, we use  $(G_{mT}^\circ - H_{m0}^\circ)/T$  instead of  $(G_{mT}^\circ - H_{m0}^\circ)$ . Hence, we have the following expression for the Gibbs function for the formation  $\Delta_f G_{mT}^\circ$  of any compound at some temperature  $T$ :

$$\frac{\Delta_f G_{mT}^\circ}{T} = \left[ \frac{\Delta_f H_{m,0K}^\circ}{T} + \left( \frac{G_{m,T}^\circ - H_{m,0K}^\circ}{T} \right) \right]_{\text{compound}} - \sum \left( \frac{G_{m,T}^\circ - H_{m,0K}^\circ}{T} \right)_{\text{elements}} \quad (12.38)$$

If the change in the Gibbs function for the formation of each substance in a reaction is known at the desired temperature, the change in the Gibbs function for any reaction involving these substances can be calculated from the equation

$$\Delta G_{mT} = \sum \Delta_f G_{mT}(\text{products}) - \sum \Delta_f G_{mT}(\text{reactants}) \quad (12.39)$$

## EXERCISES

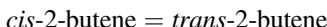
**12.1.** According to Stevenson and Morgan [6], the equilibrium constant  $K$  for the isomerization reaction



can be expressed by the equation

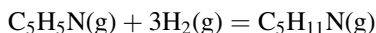
$$\ln K = 4.814 - \frac{2059}{T}$$

- Derive an equation for  $\Delta G_m^\circ$  and  $\Delta Y_m^\circ$  as a function of  $T$ .
  - Derive equations for  $\Delta H_m^\circ$  and  $\Delta S_m^\circ$  as functions of  $T$ .
  - Derive an equation for  $\Delta C_{Pm}$  as a function of  $T$ .
- 12.2. According to Golden et al. [7],  $\Delta H_m^\circ$  and  $\Delta S_m^\circ$  for the reaction



have the constant values of  $-1.2 \text{ kcal mol}^{-1}$  and  $-1.2 \text{ cal mol}^{-1} \text{ K}^{-1}$ , respectively, in the range of temperatures from 400 K to 500 K. Calculate an equation for  $\ln K$  as a function of  $T$  from their results.

- 12.3. According to Hales and Herington [8], the equilibrium constant  $K$  for the hydrogenation of pyridine ( $\text{C}_5\text{H}_5\text{N}$ ) to piperidine ( $\text{C}_5\text{H}_{11}\text{N}$ ),



in the temperature range of 140–260°C can be expressed by the equation

$$\ln K_p = -46.699 + \frac{24,320}{T}$$

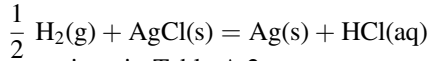
Calculate  $\Delta H_m^\circ$ ,  $\Delta S_m^\circ$ , and  $\Delta C_{Pm}^\circ$  at 200°C. (These data are for  $P^\circ = 101.325 \text{ kPa}$ .)

- 12.4. Energy changes for the conversion of the chair to the boat conformation of the cyclohexane ring can be estimated from a study of the equilibrium between *cis*- and *trans*-1,3-di-*t*-butylcyclohexane. Some analytical results of Allinger and Freiberg [9] are listed in Table 12.7.
- Compute the equilibrium constant for the reaction *cis* = *trans* at each temperature.
  - Draw a graph of  $\ln K$  against  $T$  and of  $\ln K$  against  $1/T$ . Fit the equation of  $\ln K$  against  $1/T$  by the method of linear least squares (see Appendix A) and use the residuals to decide whether the equation is linear.
  - Calculate  $\Delta H_m^\circ$  and  $\Delta S_m^\circ$  for the conformational change at 550 K.

**TABLE 12.7. Equilibrium Data for Chair to Boat Conversion**

$T/\text{K}$	492.6	522.0	555.0	580.0	613.0
% <i>trans</i>	2.69	3.61	5.09	6.42	8.23

12.5. The standard potentials for a galvanic cell in which the reaction



is being carried on are given in Table A.2.

- By numeric differentiation, construct the curve for  $(\partial \mathcal{E}^\circ / \partial T)_P$  as a function of temperature (see Appendix A for methods).
- Calculate  $\Delta G_m^\circ$ ,  $\Delta H_m^\circ$ , and  $\Delta S_m^\circ$  at 10°C, 25°C, and 50°C, respectively. Tabulate the values you obtain.
- The empirical equation for  $\mathcal{E}^\circ$  as a function of temperature is

$$\begin{aligned} \mathcal{E}^\circ = & 0.22239 - 645.52 \times 10^{-6}(t - 25) - 3.284 \times 10^{-6}(t - 25)^2 \\ & + 9.948 \times 10^{-9}(t - 25)^3 \end{aligned}$$

in which  $t$  is °C. Using this equation, compute  $\Delta G_m^\circ$ ,  $\Delta H_m^\circ$ , and  $\Delta S_m^\circ$  at 50°C. Compare these values with the values obtained by the numeric method.

12.6. Consider the problem of calculating a value for  $\Delta G_m$  as a function of the extent of reaction. For example, consider a case that can be represented as



in which the initial number of moles of  $A$  is  $n$  and the initial number of moles of  $B$  is zero. Let  $n_B$  represent the number of moles of  $B$  at any extent of reaction. If  $X$  represents the mole fraction of  $B$  formed at any time in the reaction, then  $X = n_B/n$  and  $X_A = 1 - X_B = 1 - n_B/n$ . The corresponding pressures of  $A$  and  $B$  are

$$P_A = (1 - X)P \text{ and } P_B = XP$$

in which  $P$  is the total pressure. At any extent of conversion  $n_B$ , it follows from the discussion after Equation (12.9) that

$$\left( \frac{\partial G}{\partial n_B} \right)_{T,P} = \left( \frac{1}{n} \right) \left( \frac{\partial G}{\partial X} \right)_{T,P} = \Delta G_m^\circ + RT \ln \left[ \frac{X}{(1 - X)} \right]$$

or

$$dG = n \left\{ \Delta G_m^\circ + RT \ln \left[ \frac{X}{(1 - X)} \right] \right\} dX$$

- Show that  $\Delta G$  for raising the mole fraction of  $B$  from 0 to  $X'$  is given by

$$\int_0^{X'} dG = nX\Delta G_m^\circ + nRT \left[ X' \ln \frac{X'}{1 - X'} + \ln(1 - X') \right]$$



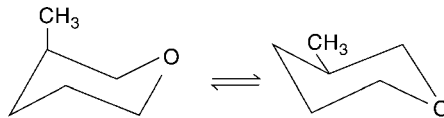
b. Prove that to reach the equilibrium state  $X_{\text{equil}}$ ,

$$\Delta G = -nRT \ln(K + 1)$$

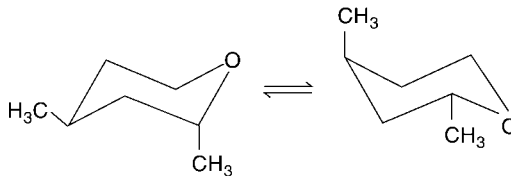
in which  $K$  is the equilibrium constant for the reaction.

12.7. Carey and Uhlenbeck [10] found the values of  $-19$  kcal/mol for  $\Delta H_m$  and  $-30$  cal/(mol K) for  $\Delta S_m$  for the reaction of a phage R17 coat protein with its 21-nucleotide RNA binding site at  $2^\circ\text{C}$ . In a similar study of the equilibrium between the *lac* repressor and its operator, de Haseth et al. [11] found that  $\Delta H_m = 8.5$  kcal/mol and  $\Delta S_m = 81$  cal/(mol K) at  $24^\circ\text{C}$ . Calculate  $\Delta Y_m$  for each reaction, and speculate on the possible significance of the difference between entropy-driven and enthalpy-driven reactions.

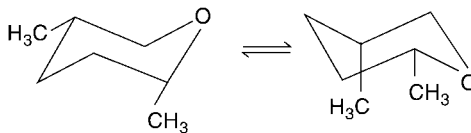
12.8. Eliel et al. [12] measured the values of  $\Delta G_m^\circ$  for the following conformational transitions:



$$1. -\Delta G_m^\circ = 1.44 \text{ kcal mol}^{-1} \text{ (173 K)}$$



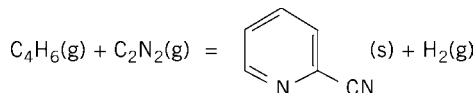
$$3. -\Delta G_m^\circ = 0.89 \text{ kcal mol}^{-1} \text{ (173 K)}$$



$$4. -\Delta G_m^\circ = 1.62 \text{ kcal mol}^{-1} \text{ (183 K)}$$

Calculate the equilibrium ratios of the conformers in each case.

12.9. It has been suggested [13] that  $\alpha$ -cyanopyridine might be prepared from cyanogen and butadiene by the reaction



**TABLE 12.8. Thermodynamic Data for Synthesis of  $\alpha$ -Cyanopyridine**

Substance	$\Delta_f H_{m298.15}^\circ / (\text{J mol}^{-1})$	$S_{m298.15}^\circ / (\text{J mol}^{-1} \text{K}^{-1})$
Butadiene (g)	111,914	277.90
Cyanogen (g)	300,495	241.17
$\alpha$ -Cyanopyridine(s)	259,408	322.54
Hydrogen(g)	0	130.58

Pertinent thermodynamic data are given in Table 12.8. From these data, would you consider it worthwhile to attempt to work out this reaction?

- 12.10.** The equilibrium constant  $K$  for the formation of a deuterium atom from two hydrogen atoms can be defined by the equations

$$2\text{H} = \text{D} \quad K = \frac{P_{\text{D}}}{(P_{\text{H}})^2} P^\circ$$

The equation for the temperature dependence of  $K$  is

$$\log_{10} K = 20.260 + 3/2 \log_{10} T + \frac{7.04 \times 10^9}{T}$$

- Calculate  $K$  at a temperature of  $10^8$  K.
  - Calculate  $\Delta G_m^\circ$ ,  $\Delta H_m^\circ$ , and  $\Delta S_m^\circ$  at the same temperature.
- 12.11.** Some thermodynamic information for benzene and its products of hydrogenation are listed in Table 12.9 [14].
- Make a graph of  $\Delta_f G_m^\circ$  for each compound, relative to benzene, against the moles of  $\text{H}_2$  consumed to form each compound. Show that the diene is thermodynamically unstable relative to any of the other three substances.
  - If hydrogenation of benzene were carried out with a suitable catalyst so that equilibrium was attained among benzene and the three products, what would be the relative composition of the equilibrium mixture at a hydrogen pressure of 101.3 kPa?

**TABLE 12.9. Thermodynamic Data for Benzene and Related Compounds**

Substance	$\Delta_f H_{m298}^\circ / (\text{kJ mol}^{-1})$	$S_{m298}^\circ / (\text{J mol}^{-1} \text{K}^{-1})$
Benzene	82.93	269.0
1,3-Cyclohexadiene	107.1	288.3
Cyclohexene	-7.20	310.5
Cyclohexane	-123.14	298.3

**TABLE 12.10. Thermodynamic Data for Tin**

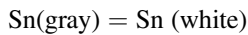
	Sn(gray)	Sn(white)
$\Delta_f H_{m298}^\circ / (\text{J mol}^{-1})$	-2090	0
$S_{m298}^\circ / (\text{J mol}^{-1} \text{K}^{-1})$	44.14	51.55
Density / ( $\text{g cm}^{-3}$ )	5.75	7.31

**12.12.** Some thermodynamic data for tin are tabulated in Table 12.10.

It is possible to construct an electrochemical cell

Sn (gray), electrolyte, Sn(white)

in which the following reaction occurs during operation:



- Compute the emf of this cell at 25°C and 100 kPa.
  - If the cell is operated reversibly, what would be the values of  $W_{\text{net}}$ ,  $Q$ ,  $\Delta E$ ,  $\Delta H$ ,  $\Delta S$ , and  $\Delta G$ , respectively, for the conversion of one mole of gray tin to white tin?
  - If the cell is short-circuited so that no electrical work is obtained, what would be the values of the thermodynamic quantities listed in (b)?
- 12.13.** The heats of combustion of quinone(s) and hydroquinone(s) at 1 atm and 25°C are 2745.92 and 2852.44 kJ mol<sup>-1</sup>, respectively [15]. Entropies have been computed from specific heat data;  $S_{m298}^\circ$  is 161.29 J mol<sup>-1</sup> K<sup>-1</sup> for quinone(s) and 137.11 J mol<sup>-1</sup> K<sup>-1</sup> for hydroquinone(s).

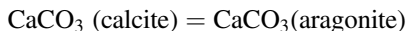
- Compute  $\Delta_f H_m^\circ$ , the standard enthalpy of formation, for quinone and hydroquinone.
- Compute  $\Delta H_m^\circ$  for the reduction of quinone to hydroquinone.
- Compute  $\Delta S_m^\circ$  and  $\Delta G_m^\circ$  for the reduction of quinone to hydroquinone.
- The reduction of quinone to hydroquinone can be carried out in an electrochemical cell in which one electrode contains a solution saturated with an equimolar mixture of quinone and hydroquinone called quinhydrone, and the other electrode is the standard hydrogen electrode.

Calculate  $\mathcal{E}^\circ$  for this cell from the data above. The value obtained from electrochemical measurements [16] is 0.681 V.

**TABLE 12.11. Thermodynamic Data for Calcium Carbonate**

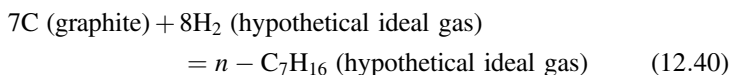
	Calcite	Aragonite
$\Delta_f H_{m298}^\circ / (\text{kJ mol}^{-1})$	-1207.5	-1207.9
$S_{m298}^\circ / (\text{J mol}^{-1} \text{K}^{-1})$	+91.7	+88.0

- 12.14.** The values of  $\Delta_f H_m^\circ$  and  $S_m^\circ$  for  $\text{CaCO}_3$  (calcite) and  $\text{CaCO}_3$  (aragonite) are given in Table 12.11 [16]. Predict the thermodynamically stable form of  $\text{CaCO}_3$  at 298 K from the value of  $\Delta G_m^\circ$  for the transformation

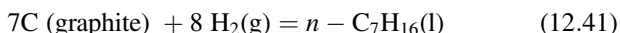


- 12.15.** The following problem illustrates the application of calculations involving the third law to a specific organic compound, *n*-heptane. The necessary data can be obtained from sources mentioned in the footnote to Table 12.2, in Table A.4, and in the problem.

- a.** From the published tables of the enthalpy increment function,  $(H_{mT}^\circ - H_{m0}^\circ)/T$ , compute  $\Delta H_m^\circ$  for the reaction (at 298.15 K)



- b.** With the aid of data for the vaporization of *n*-heptane, calculate  $\Delta H_{m,298.15}^\circ$  for the reaction



- c.** Calculate  $S_{m,298.15}^\circ$  for liquid *n*-heptane from the heat capacity data below (Values calculated from data below (see Ref. 17) and from those for solid *n*-heptane given in Table A.4. Integrate by means of the Debye equation to obtain the entropy up to 15.14 K, and carry out a numeric integration

**TABLE 12.12. Heat Capacities of Liquid *n*-Heptane\***

$T/\text{K}$	$C_{pm}/\text{J mol}^{-1} \text{K}^{-1}$
182.55	203.01
190	201.96
200	201.46
210	201.79
220	202.88
230	204.51
240	206.61
250	209.12
260	211.96
270	215.02
280	218.36
290	221.92
298.15	224.93

\*Values calculated from the data of Ref. 17.

- ( $C_{P,m}/T$  vs.  $T$ ) thereafter. Obtain  $\Delta H_m^\circ$  of fusion from Thermodynamics Research Center tables.
- Calculate  $\Delta S_m^\circ$  for Reaction (12.29) at 298.15 K. Use National Bureau of Standards data on graphite and hydrogen.
  - Calculate the entropy of vaporization of liquid  $n$ -heptane at 298.15 K.
  - Calculate  $\Delta_f G_{m,298.15}^\circ$  for liquid  $n$ -heptane.
  - Calculate  $\Delta_f G_{m,298.15}^\circ$  for gaseous  $n$ -heptane.
  - From tables of the free energy increment function ( $G_{mT}^\circ - H_{m0}^\circ)/T$ , calculate  $\Delta_f G_{m,298.15}^\circ$  for gaseous  $n$ -heptane in the hypothetical ideal gas standard state. Compare with the value obtained in (f).
- 12.16.** Ha et al. [18] have measured the equilibrium quotients for the formation of a complex between the lac repressor protein and a symmetric operator sequence of DNA as a function of temperature. Their results are given below. (The standard state is 1 mol dm<sup>-3</sup>.)

$T/^\circ\text{C}$	$K_{\text{obs}}$
0.0	$1.7(\pm 0.2) \times 10^{10}$
7.0	$7.9(\pm 2.7) \times 10^{10}$
14.0	$1.1(\pm 0.1) \times 10^{11}$
23.0	$1.2(\pm 0.3) \times 10^{11}$
30.0	$5.2(\pm 1.5) \times 10^{10}$
37.0	$6.0(\pm 1.7) \times 10^{10}$
41.0	$2.8(\pm 0.6) \times 10^{10}$

As  $K_{\text{obs}}$  goes through a maximum with increasing  $T$ ,  $\Delta C_P$  is not equal to zero. The authors fitted their data to the expression

$$\ln K_{\text{obs}} = \left( \frac{\Delta C_{P,\text{obs}}^\circ}{R} \right) \left[ \left( \frac{T_H}{T} \right) - \ln \left( \frac{T_S}{T} \right) - 1 \right] \quad (12.42)$$

in which  $\Delta C_{P,\text{obs}}^\circ$  is assumed to be temperature independent,  $T_H$  is the temperature at which  $\Delta H_{\text{obs}}^\circ$  is equal to zero, and  $T_S$  is the temperature at which  $\Delta S_{\text{obs}}^\circ$  is equal to zero.

- Derive Equation (12.42), starting with the assumption that  $\Delta C_P^\circ$  is a constant.
  - Calculate  $\Delta Y_{\text{obs}}^\circ$  at each experimental temperature.
  - Use a nonlinear fitting program to obtain the values of the parameters,  $\Delta C_{P,\text{obs}}^\circ$ ,  $T_H$ , and  $T_S$ , and calculate  $\Delta H_{\text{obs}}^\circ$  and  $\Delta S_{\text{obs}}^\circ$  at each experimental temperature. Because this is a complex equation for a small dataset, it may be necessary to obtain values of  $T_H$  and  $T_S$  from plots of  $\ln K$  and  $\Delta G$ , and to obtain only  $\Delta C_{P,\text{obs}}^\circ$  from a nonlinear fitting procedure.
- 12.17.** The thermodynamic parameters for the dissociation of double-stranded DNA into single strands can be obtained from a determination of the “melting temperature”  $T_m$  as a function of the total concentration of strands  $C_T$ . The melting

temperature is defined as the temperature at which  $\alpha$ , the fraction of total strands present as single strands, is equal to 0.5.

- a. Derive an expression for  $K$  for the dissociation in terms of  $\alpha$  and  $C_T$ , and use that expression to show that

$$\frac{1}{T_m} = \frac{R \ln C_T}{\Delta H^\circ} + \frac{\Delta S^\circ}{\Delta H^\circ}$$

- b. How would you plot data on melting temperature as a function of total strand concentration to obtain  $\Delta H^\circ$  and  $\Delta S^\circ$ ?

## REFERENCES

1. H. J. Kolb and R. L. Burwell, Jr., *J. Am. Chem. Soc.* **67**, 1084 (1945).
2. H. A. Bent, *J. Chem. Educ.* **50**, 323 (1973); J. N. Spencer, *J. Chem. Educ.* **51**, 577 (1974).
3. E. Hamori, *J. Chem. Educ.* **52**, 370 (1975).
4. H. E. Davenport and R. Hill, *Proc. Roy. Soc., Series B* **139**, 327 (1952); F. L. Rodkey and E. G. Ball, *J. Biol. Chem.* **182**, 17 (1950).
5. T. Wiseman, S. Williston, J. F. Brandts, and L.-N. Lin, *Anal. Biochem.* **179**, 131 (1989); G. Arena, R. Calí, G. Maccarrone, and R. Purello, *Thermochimica Acta* **155**, 353 (1989); M. J. Blandamer, P. M. Cullis, and J. B. F. N. Engberts, *J. Chem. Soc. Faraday Trans.* **94**, 2261 (1998).
6. D. P. Stevenson and J. H. Morgan, *J. Am. Chem. Soc.* **70**, 2773 (1948).
7. D. M. Golden, K. W. Egger, and S. W. Benson, *J. Am. Chem. Soc.* **86**, 5416 (1969).
8. J. L. Hales and E. F. G. Herington, *Trans. Faraday Soc.* **53**, 616 (1957).
9. Reprinted with permission from N. L. Allinger and L. A. Freiberg, *J. Am. Chem. Soc.* **82**, 2393 (1960). Copyright 1960 American Chemical Society.
10. J. Carey and O. C. Uhlenbeck, *Biochemistry* **22**, 2610 (1983).
11. P. de Haseth, T. M. Lohman, and M. T. Record, Jr., *Biochemistry* **16**, 4783 (1977).
12. Reprinted with permission from B. E. Eliel, K. D. Hargrave, K. M. Pietrusiewicz, and M. Manoharan, *J. Am. Chem. Soc.* **104**, 3635 (1982). Copyright 1982 American Chemical Society.
13. G. J. Janz, *Can. J. Res.* **25b**, 331 (1947).
14. G. J. Janz, *J. Chem. Phys.* **22**, 751 (1954).
15. G. Pilcher and L. E. Sutton, *J. Chem. Soc.* **1956**, 2695.
16. J. B. Conant and L. F. Fieser, *J. Am. Chem. Soc.* **44**, 2480 (1922).
17. J. P. McCullough and J. F. Messerley, *United States Bureau of Mines Bulletin* **596**, (1961).
18. J.-H. Ha, R. S. Spolar, and M. T. Record, Jr., *J. Mol. Biol.* **209**, 801 (1989).



## CHAPTER 13

---

# THE PHASE RULE

---

The mathematical basis of classic thermodynamics was developed by J. Willard Gibbs in his essay [1], “On the Equilibrium of Heterogeneous Substances,” which builds on the earlier work of Kelvin, Clausius, and Helmholtz, among others. In particular, he derived the phase rule, which describes the conditions of equilibrium for multiphase, multicomponent systems, which are so important to the geologist and to the materials scientist. In this chapter, we will present a derivation of the phase rule and apply the result to several examples.

### 13.1 DERIVATION OF THE PHASE RULE

The phase rule is expressed in terms of  $\phi$ , the number of phases in the system;  $C$ , the number of components; and  $F$ , the number of degrees of freedom or the variance of the system.

The number of phases is the number of different homogeneous regions in the system. Thus, in a system containing liquid water and several chunks of ice, only two phases exist. The number of degrees of freedom is the number of intensive variables that can be altered freely without the appearance or disappearance of a phase. First we will discuss a system that does not react chemically, that is, one in which the number of components is simply the number of chemical species.



### Nonreacting Systems

If we express the composition of a phase in terms of the mole fractions of all the components, then  $(C - 1)$  intensive variables are needed to describe the composition, if every component appears in the phase, because the mole fractions must sum to 1. In a system of  $\varphi$  phases,  $\varphi(C - 1)$  intensive variables are used to describe the composition of the system. As was pointed out in Section 3.1, a one-phase, one-component system can be described by a large number of intensive variables; yet the specification of the values of any two such variables is sufficient to fix the state of such a system. Thus, for example, two variables are needed to describe the temperature and pressure of each phase of constant composition or any alternative convenient choice of two intensive variables. Therefore, the total number of variables needed to describe the state of the system is

$$\varphi(C - 1) + 2\varphi = \varphi(C + 1) \quad (13.1)$$

To calculate the number of degrees of freedom, we need to know the number of constraints placed on the relationships among the variables by the conditions of equilibrium.

**Mechanical Equilibrium.** For a system of fixed *total* volume and of uniform temperature throughout, the condition of equilibrium is given by Equation (7.9) as

$$dA = 0$$

If phase I of the system changes its volume, with a concurrent compensating change in the volume of phase II, then at constant temperature, it follows from Equation (7.39) that

$$\begin{aligned} dA &= dA_I + dA_{II} \\ &= -P_I dV_I - P_{II} dV_{II} = 0 \end{aligned} \quad (13.2)$$

As the total volume is fixed,

$$dV_I = -dV_{II}$$

and

$$P_{II} dV_I - P_I dV_I = 0 \quad (13.3)$$

The equilibrium constraint of Equation (13.3) can be met only if  $P_I = P_{II}$ , which is the condition for *mechanical equilibrium*. (We will discuss several special cases to which this requirement does not apply.) Or, to put the argument differently, if the pressures of two phases are different, the phase with the higher pressure will spontaneously expand; and the phase with the lower pressure will spontaneously contract, with a decrease in  $A$ , until the pressures are equal. Thus, for  $\varphi$  phases,  $\varphi - 1$  independent relationships among the pressures of the phases can be written as follows:

$$P_I = P_{II} = \cdots = P_\varphi$$

**Thermal Equilibrium.** For an isolated system, one at constant total energy and constant total volume, the condition of equilibrium follows from Equation (6.108) as

$$dS = 0 \quad (13.4)$$

If an infinitesimal amount of heat  $DQ$  is transferred reversibly from phase I to phase II, it follows from Equation (6.49) that

$$\begin{aligned} dS &= dS_{\text{I}} + dS_{\text{II}} \\ &= -\frac{DQ}{T_{\text{I}}} + \frac{DQ}{T_{\text{II}}} = 0 \end{aligned} \quad (13.5)$$

The constraint of Equation (13.5) can be met only if  $T_{\text{I}} = T_{\text{II}}$ , which is the condition for *thermal equilibrium*. Or, to put the argument differently, if the temperatures of two phases differ, heat will flow irreversibly from the phase at higher temperature to the phase at lower temperature, with an increase in entropy, until the temperatures are equal. Thus, for  $\varphi$  phases,  $\varphi - 1$  independent relationships among the temperatures of the phases can be written as follows:

$$T_{\text{I}} = T_{\text{II}} = \cdots = T_{\varphi}$$

**Transfer Equilibrium.** For a system at constant temperature and pressure, the condition of equilibrium is given from Equation (7.18) as

$$dG = 0 \quad (13.6)$$

If  $dn$  moles of a substance are transferred from phase I to phase II, then it follows from Equation (9.15) that

$$dG = -\mu_{\text{I}}dn + \mu_{\text{II}}dn = 0 \quad (13.7)$$

The condition of Equation (13.7) can be met only if  $\mu_{\text{I}} = \mu_{\text{II}}$ , which is the condition of *transfer equilibrium* between phases. Or, to put the argument differently, if the chemical potentials (escaping tendencies) of a substance in two phases differ, spontaneous transfer will occur from the phase of higher chemical potential to the phase of lower chemical potential, with a decrease in the Gibbs function of the system, until the chemical potentials are equal (see Section 10.5). For each component present in all  $\varphi$  phases,  $(\varphi - 1)$  equations of the form of Equation (13.7) provide constraints at transfer equilibrium. Furthermore, an equation of the form of Equation (13.7) can be written for each one of the  $C$  components in the system in transfer equilibrium between any two phases. Thus,  $C(\varphi - 1)$  independent relationships among the chemical potentials can be written. As chemical potentials are functions of the mole fractions at constant temperature and pressure,  $C(\varphi - 1)$  relationships exist among the mole fractions. If we sum the independent relationships for temperature,

pressure, and composition in the system, we find

$$(\phi - 1) + (\phi - 1) + C(\phi - 1) = (C + 2)(\phi - 1) \quad (13.8)$$

independent relationships or constraints exist among the variables.

**The Phase Rule.** The number of degrees of freedom is the difference between the number of variables needed to describe the system and the number of independent relationships or constraints among those variables:

$$\begin{aligned} F &= \phi(C + 1) - (\phi - 1)(C + 2) \\ &= C - \phi + 2 \end{aligned} \quad (13.9)$$

In a system in which one component is absent from a phase, the number of variables needed to describe the system decreases by one. As the number of independent relationships also decreases by one, the number of degrees of freedom remains the same.

### Reacting Systems

For a system undergoing  $R$  independent chemical reactions among  $N$  chemical species,  $R$  equilibrium expressions are to be added to the relationships among the intensive variables. From Equation (13.1), the total number of intensive variables in terms of  $N$  becomes

$$\phi(N - 1) + 2\phi = \phi(N + 1) \quad (13.10)$$

If we add  $R$  to the number of independent relationships specified by Equation (13.8), we obtain

$$(N + 2)(\phi - 1) + R \quad (13.11)$$

Thus, the number of degrees of freedom for a reacting system is

$$\begin{aligned} F &= \phi(N + 1) - (N + 2)(\phi - 1) - R \\ &= (N - R) - \phi + 2 \end{aligned} \quad (13.12)$$

We define the number of components in a system as  $N - R$ , which is also the minimum number of chemical species from which all phases in the system can be prepared. Each equilibrium relationship decreases by one the number of species required to prepare a phase. Thus, the quantity  $(N - R)$  in Equation (13.12) is equivalent to  $C$  in Equation (13.9). For example, water in equilibrium with its vapor at room temperature and atmospheric pressure is a one-component system. Water in equilibrium with  $\text{H}_2$  and  $\text{O}_2$  at a temperature and pressure at which dissociation

takes place is a two-component system unless the mole ratio of  $\text{H}_2/\text{O}_2$  is exactly 2; then  $C = 1$ . Water in equilibrium with  $\text{OH}^-$  and  $\text{H}^+$  ions at room temperature and atmospheric pressure is a one-component system because the requirement for electrical neutrality in ionic solutions imposes an additional relationship on the system.

## 13.2 ONE-COMPONENT SYSTEMS

The number of degrees of freedom for a one-component system [ $C = 1$  in Equation (13.9)] is

$$F = 3 - \phi \quad (13.13)$$

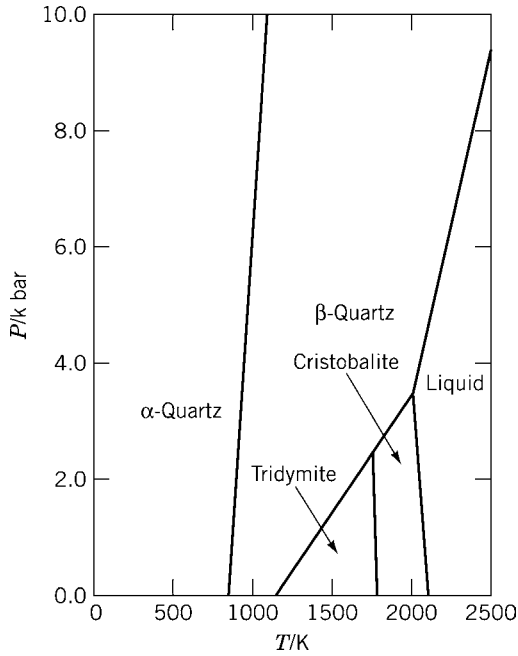
$F$  is at most two because the minimum value for  $\phi$  is one. Thus, the temperature and pressure can be varied independently for a one-component, one-phase system and the system can be represented as an area on a temperature versus pressure diagram.

If two phases of one component are present, only one degree of freedom remains, either temperature or pressure. Two phases in equilibrium are represented by a curve on a  $T - P$  diagram, with one independent variable and the other a function of the first. When either temperature or pressure is specified, the other is determined by the Clapeyron Equation (8.9). If three phases of one component are present, no degrees of freedom remain, and the system is invariant. Three phases in equilibrium are represented on a  $T - P$  diagram by a point called the *triple point*. Variation of either temperature or pressure will cause the disappearance of a phase.

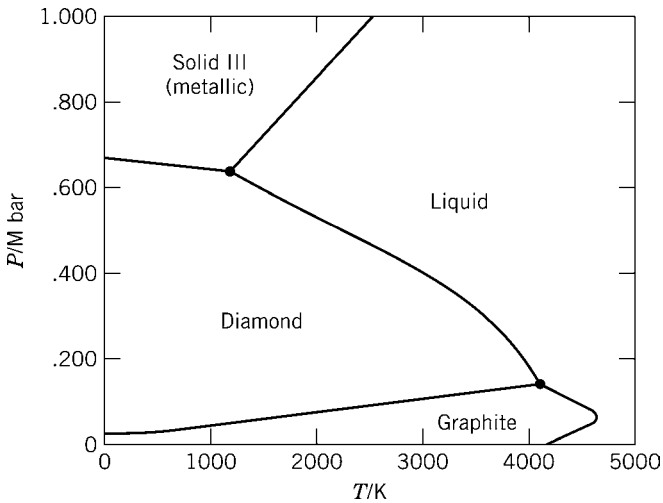
An interesting example of a one-component systems is  $\text{SiO}_2$ , which can exist in five different crystalline forms or as a liquid or a vapor. As  $C = 1$ , the maximum number of phases that can coexist at equilibrium is three. Each phase occupies an area on the  $T - P$  diagram; the two-phase equilibria are represented by curves and the three-phase equilibria by points. Figure 13.1 (2, p. 123), which displays the equilibrium relationships among the solid forms of  $\text{SiO}_2$ , was obtained from calculations of the temperature and pressure dependence of  $\Delta G$  (as described in Section 7.3) and from experimental determination of equilibrium temperature as a function of equilibrium pressure.

A one-phase system that is important in understanding the geology of diamonds as well as the industrial production of diamonds is that of carbon, which is shown in Figure 13.2. The phase diagram shows clearly that graphite is the stable solid phase at low pressure. Thus, diamond can spontaneously change to graphite at atmospheric pressure ( $\sim 10^5$  Pa). Diamond owners obviously need not worry, however; the transition in the solid state is infinitely slow at ordinary temperatures. Some uncertainties about the phase diagram for carbon are discussed by Bundy [3].

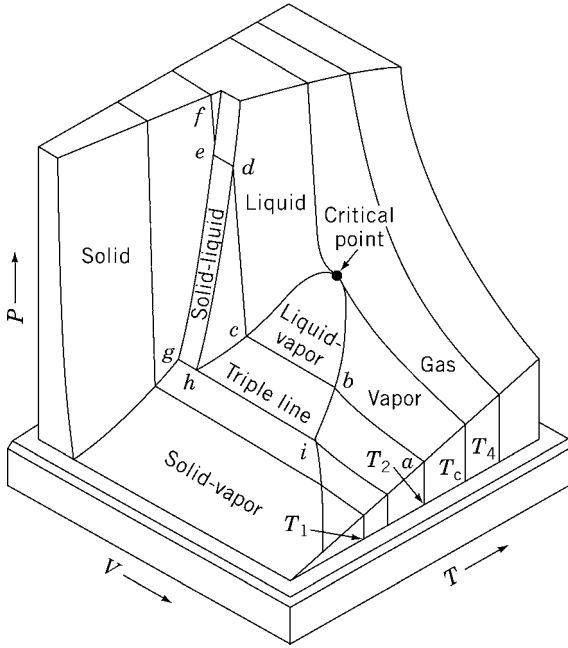
Although phase diagrams such as Figure 13.1 and Figure 13.2 describe the conditions of  $T$  and  $P$  at which different phases are stable, they do not describe the properties of the system. As the specification of two intensive variables is sufficient to fix all other intensive variables, the variation of any other intensive variable can be described in terms of a surface above the  $T - P$  plane, and the height of any point



**Figure 13.1.** Phase diagram for SiO<sub>2</sub> for a range of pressures and temperatures. From data in the sources in Ref. 2 (p. 123).



**Figure 13.2.** Phase diagram for carbon. From C. G. Suits, *Am. Sci.* **52**, 395 (1964).



**Figure 13.3.** A  $P$ - $V$ - $T$  surface for a one-component system in which the substance contracts on freezing, such as water. Here  $T_1$  represents an isotherm below the triple-point temperature,  $T_2$  represents an isotherm between the triple-point temperature and the critical temperature,  $T_c$  is the critical temperature, and  $T_4$  represents an isotherm above the triple-point temperature. Points  $g$ ,  $h$ , and  $i$  represent the molar volumes of solid, liquid, and vapor, respectively, in equilibrium at the triple-point temperature. Points  $e$  and  $d$  represent the molar volumes of solid and liquid, respectively, in equilibrium at temperature  $T_2$  and the corresponding equilibrium pressure. Points  $c$  and  $b$  represent the molar volumes of liquid and vapor, respectively, in equilibrium at temperature  $T_2$  and the corresponding equilibrium pressure. From F. W. Sears and G. L. Salinger, *Thermodynamics, Kinetic Theory, and Statistical Thermodynamics*. 3rd ed., Addison-Wesley, Reading, MA, 1975, p. 31.

in the surface about the  $T - P$  plane represents the value of the intensive variable. Figure 13.3 shows such a surface for the molar volume  $V_m$  as a function of  $T$  and  $P$ . When two or more phases are present at equilibrium,  $V_m$  is a multivalued function of  $T$  and  $P$ . Similar surfaces can be constructed to describe other thermodynamic properties, such as  $G$ ,  $H$ , and  $S$ , relative to some standard value.

### 13.3 TWO-COMPONENT SYSTEMS

From Equation (13.9), it follows that the number of degrees of freedom for a two-component system

$$F = 4 - \phi \quad (13.14)$$

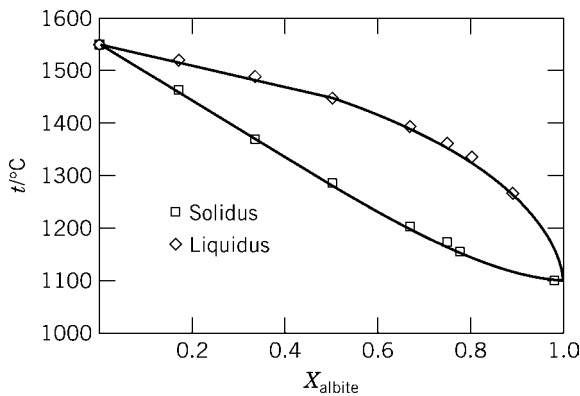
has a maximum value of three. As a complete representation of such a system requires three coordinates, we can decrease the variance by fixing the temperature and leaving pressure and composition as the variables of the system, or by fixing the pressure and leaving temperature and composition as the variables of the system. Then,

$$F = 3 - \phi \quad (13.15)$$

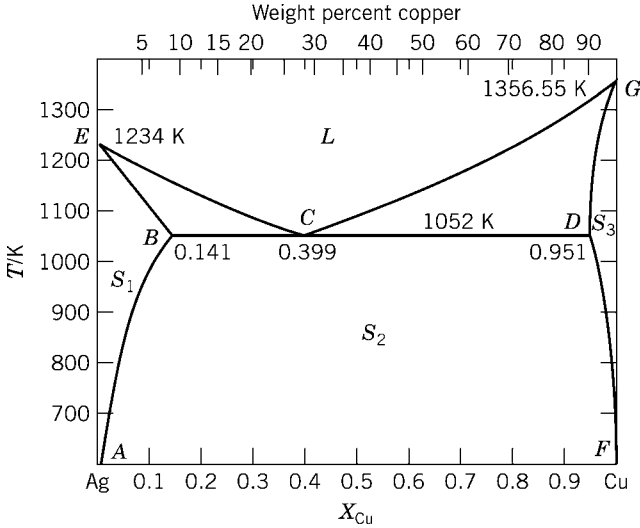
In a reduced-phase diagram for a two-component system,  $F = 2$  for a single phase and an area is the appropriate representation.  $F = 1$  for two phases in equilibrium, and a curve that relates the two variables is the appropriate representation. As the composition of the two phases generally is different, two conjugate curves are required.

Figure 13.4 [4] is a reduced two-component diagram for the mineral feldspar, which is a solid solution of Albite ( $\text{NaAlSi}_3\text{O}_8$ ) and anorthite ( $\text{CaAlSi}_2\text{O}_8$ ). Above the liquidus curve, the system exists as a single liquid phase. Between the two curves, liquid and solid phases are in equilibrium, and their compositions are given by the intersections of a constant temperature line with liquidus and solidus curves. A point in the region between the two curves represents only the overall composition of the system and not the composition of either phase. This value is not described by the phase rule, which is concerned only with the number of phases and their composition. Although the region between the curves is frequently called a “two-phase area,” only the curves correspond geometrically to a value of  $F = 1$  [5].

Other two-component systems may exhibit either limited solubility or complete insolubility in the solid state. An example with limited solubility is the silver–copper system, of which the reduced-phase diagram is shown in Figure 13.5. Region  $L$  represents a liquid phase, with  $F = 2$ , and  $S_1$  and  $S_3$  represent solid-solution phases rich in Ag and Cu, respectively, so they are properly called “one-phase areas.”  $S_2$  is a two-phase region, with  $F = 1$ , and the curves  $AB$  and  $DF$  represent the compositions of the two solid-solution phases that are in equilibrium at any



**Figure 13.4.** Phase diagram of the system feldspar, a solid solution of albite ( $\text{NaAlSi}_3\text{O}_8$ ) and anorthite ( $\text{CaAlSi}_2\text{O}_8$ ). Data from Ref. 4.

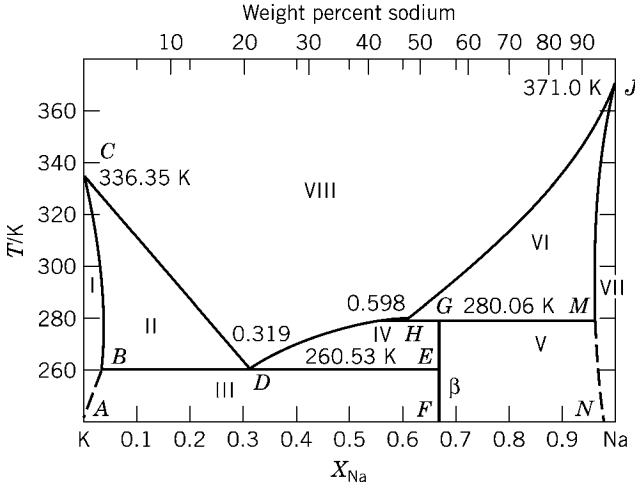


**Figure 13.5.** The phase diagram for the system Ag-Cu at constant pressure. With permission, from R. Hultgren, P. D. Desai, D. T. Hawkins, M. Gleiser, and K. K. Kelley, *Selected Values of Thermodynamic Properties of Binary Alloys*, American Society of Metals, Metals Park, OH, 1973, p. 46.

temperature. At 1052 K, liquid of composition *C* is in equilibrium with solid solutions of composition *B* and *D*. With three phases,  $F = 0$ , and the three compositions are represented by points *B*, *C*, and *D*. Between 1052 K and 1234 K, lines *EB* and *EC* represent the compositions of solid solution and liquid solution, respectively, in equilibrium, with overall system composition richer in Ag than at *C*. Curves are appropriate because  $F = 1$ . Between 1052 K and 1356.55 K, lines *GC* and *GD* represent the compositions of liquid solution and solid solution, respectively, in equilibrium, with overall system composition richer in Cu than at *C*.

In two-component phase diagrams such as Figure 13.5 and Figure 13.6, the distinction between two-phase regions and one-phase regions is made on the basis of the number of degrees of freedom represented by each. The one-phase region has two degrees of freedom, two variables can be varied freely, and the region is truly an “area.” The two-phase region has only one degree of freedom, only one variable can be varied freely, and the second variable is a function of the first, with the function represented by a curve. Because two phases of different compositions in equilibrium exist, two different curves exist, which bound a region. The two kinds of region can be distinguished because the two-phase region is bounded by curves that represent a function; therefore, the curves must have continuous first derivatives in the range of temperature characteristic of the region. The same is not required of the boundaries of one-phase regions, which are true areas and are not bounded by curves that represent functions [5].





**Figure 13.6.** The phase diagram at constant pressure of the system Na-K. With permission, from R. Hultgren, D. T. Hawkins, M. Gleiser, and K. K. Kelley, *Selected Values of Thermodynamic Properties of Binary Alloys*, American Society of Metals, Metals Park, OH, 1973, p. 1057.

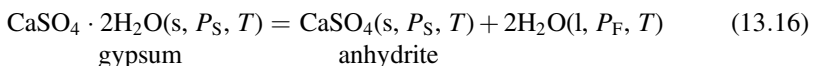
Figure 13.6 is the phase diagram of the system Na-K at constant pressure, which is a system that exhibits limited solubility and the occurrence of a solid compound  $\text{Na}_2\text{K}$  ( $\beta$ ), which melts at 280.06 K to form a solid solution of composition rich in Na and liquid of composition H.

Although the phase rule is concerned with the number of relationships among system variables that are represented by the equilibrium curves, it provides no information about the nature of those relationships. We will consider the dependence of the chemical potential on the system variables for various systems in later chapters.

## Two Phases at Different Pressures

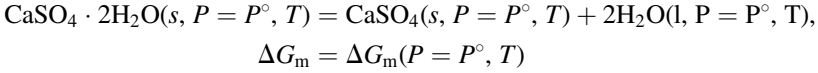
When we derived the phase rule, we assumed that all phases are at the same pressure. In mineral systems, fluid phases can be at a pressure different from the solid phases if the rock column above them is permeable to the fluid. Under these circumstances, the system has an additional degree of freedom and the equilibrium at any depth depends on both the fluid pressure  $P_F$  and the pressure on the solid  $P_S$  at that level. Each pressure is determined by  $\rho$ , the density of the phase, and  $h$ , the height of the column between the surface and the level being studied.

The equations required to calculate the effect of pressure and temperature on  $\Delta G$  are modified from Equation (7.43) to include a term for each pressure at any temperature  $T$ . For example, for the gypsum–anhydrite equilibrium,

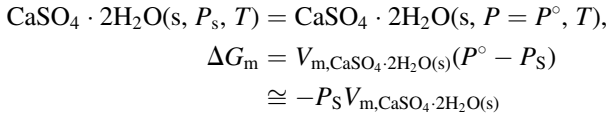


the change in the Gibbs function can be computed by resolving the transformation into the following four steps:

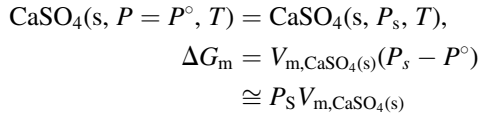
Step 1.



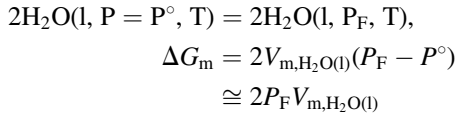
Step 2.



Step 3.



Step 4.



The approximations for Steps 2 through 4 are reasonable because  $P^\circ$ , atmospheric pressure, is small compared with  $P_F$  and  $P_S$ , the high pressures found in geologic formations.

The sum of the transformations in Steps 1 through 4 leads to the change shown in Equation (13.16). The sum of the  $\Delta G_m$ 's for Steps 1 through 4 produces Equation (13.17)

$$\Delta G_m(P_F, P_S, T) = \Delta G_m(P = P^\circ, T) + P_S(\Delta V_{mS}) + P_F(\Delta V_{mF}) \quad (13.17)$$

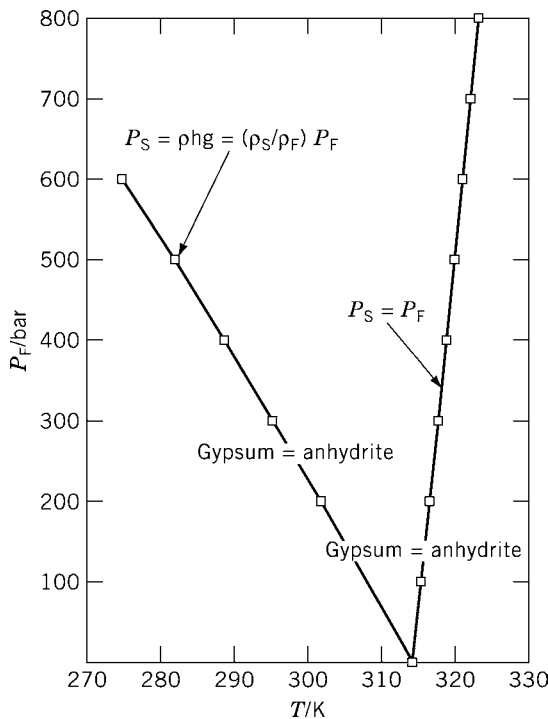
in which  $\Delta V_{mS}$  represents the molar volume change of the solid phases in the transformation and  $\Delta V_{mF}$  represents the molar volume change of the fluid phase in the transformation. (See Table 2.1 for the definition of one mole for a chemical transformation.) That is,

$$\Delta V_{mS} = V_{m, \text{CaSO}_4(s)} - V_{m, \text{CaSO}_4 \cdot 2\text{H}_2\text{O}(s)} = -29.48 \text{ cm}^3 \text{ mol}^{-1} \quad (13.18)$$

and

$$\Delta V_{m,F} = 2V_{m,H_2O(l)} = 36.14 \text{ cm}^3 \text{ mol}^{-1} \quad (13.19)$$

The equilibrium diagram (2, p. 274; 6) for the species in Equation (13.16) is shown in Figure 13.7. If gypsum and anhydrite are both under liquid water at 1 bar, then equilibrium can be attained only at 40°C (see Fig. 13.7). If the liquid pressure is increased, and the rock formation is completely impermeable to the liquid phase, so that the pressure on the fluid phase is equal to the pressure on the solid phase, then the temperature at which the two solids, both subject to this liquid pressure, are in equilibrium is given by the curve with positive slope on the right side of Figure 13.7. Thus, the right curve applies to any situation in which  $P_F$  is equal to  $P_S$ . Under these conditions, the net  $\Delta V_m$  for the transformation of Equation (13.16) is  $36.14 - 29.48 = 6.66 \text{ cm}^3$  [see Equations (13.18) and (13.19)], and  $6.66 \times P_F$  makes a positive contribution to the  $\Delta G_m$  of Equation (13.17). Thus, an increase in pressure should shift the equilibrium from anhydrite to gypsum, as indicated in Figure 13.7.



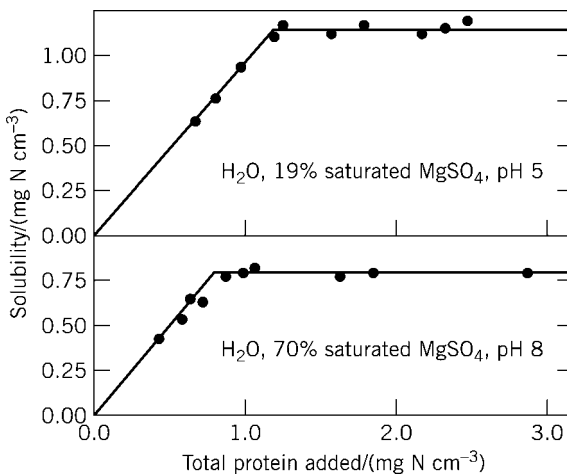
**Figure 13.7.** Equilibrium diagram for transformations in Equation (13.16). Gibbs function data from K. K. Kelley, J. Southard, and C. T. Anderson, *Bureau of Mines Technical Paper 625*, 1941.

In contrast, if the rock above the layer being studied is completely permeable to the fluid, the pressure on the solid phases is that of the overlying rock  $\rho_s hg$ , whereas the pressure on the fluid phase is  $\rho_f hg$ , in which  $g$  is the acceleration caused by gravity. Under these circumstances, the equilibrium temperature for the transformation in Equation (13.16) varies with pressure according to the curve with negative slope at the left side of Figure 13.7. In this case,  $P_S \Delta V_{mS}$  ( $-29.48 \times P_S$ ) exceeds  $P_F \Delta V_{mF}$  ( $36.14 \times P_F$ ) in magnitude, and the net contribution to  $\Delta G$  of the  $P \Delta V$  terms in Equation (13.17) is negative. Hence, increased pressure shifts the equilibrium from gypsum to anhydrite. If the rock is partially permeable, the equilibrium curve falls between the two curves shown, the exact position depending on the ratio of  $P_F$  to  $P_S$ . At some value of the ratio between unity and  $\rho_F/\rho_S$ , the equilibrium temperature becomes independent of the pressure. Whatever the position of the equilibrium curve, gypsum is the stable solid phase at low temperatures (to the left of the curve) and anhydrite is the stable solid phase at high temperatures (to the right of the curve).

### Phase Rule Criterion of Purity

Equation (13.9) is written as if the number of degrees of freedom of a system were calculated from known values of the number of phases and the number of components. In practice, an experimentalist often determines  $F$  and  $\phi$  from his or her observation and then calculates  $C$ , the number of components.

The determination of the purity of a homogeneous solid from solubility measurements is an example of this application of the phase rule. The experimental procedure



**Figure 13.8.** Solubility curves of chymotrypsinogen A in two different solvents. Adapted from J. H. Northrop, M. Kunitz, and R. M. Herriot, *Crystalline Enzymes*, 2nd ed., Columbia University Press, New York, 1948. Originally published in *J. Gen. Physiol.* **24**, 196 (1940); reproduced by copyright permission of the Rockefeller University Press.

is to measure the concentration of dissolved material in equilibrium with excess solid, at a fixed temperature and pressure, as a function of the amount of solid added. If the solid is pure, the solid and solvent constitute a two-component system. At constant temperature and pressure,  $F = 2 - \phi$  and a two-phase system of solid and saturated solution has zero degrees of freedom. If the solid contains more than one species, the system has three components and  $F = 1$  when two phases are present. In the former case, the solubility is independent of the amount of excess solid; in the latter case, the solubility increases with the amount of added solid. Figure 13.8 shows the data of Butler [7] on the solubility of chymotrypsinogen A, which was the precursor of the pancreatic enzyme chymotrypsin. These data represent one of the earliest rigorous demonstrations of the purity of a protein.

## EXERCISES

- 13.1.** What would be the number of degrees of freedom in a system in which pure  $\text{H}_2\text{O}$  was increased to a temperature sufficiently high to allow dissociation into  $\text{H}_2$  and  $\text{O}_2$ ?
- 13.2.** At atmospheric pressure (101.325 kPa),  $\alpha$  quartz is in equilibrium with  $\beta$  quartz at  $847 \pm 1.5$  K [8]. The enthalpy change of the transition from  $\alpha$  quartz to  $\beta$  quartz is  $728 \pm 167$  J mol $^{-1}$ . Berger et al. [9] measured the volume change by an X-ray diffraction method, and they reported a value of  $0.154 \pm 0.015$  cm $^3$  mol $^{-1}$ . Use these values to calculate the slope at atmospheric pressure of the equilibrium curve between  $\alpha$  quartz and  $\beta$  quartz in Figure 13.1. Compare your results with the value of the pressure derivative of the equilibrium temperature  $dT/dP$ , which is equal to  $0.21$  K (Mpa) $^{-1}$  [10].
- 13.3.** For Equation (13.16) [2]

$$\Delta G_m(P = P^\circ, T) = -10,430 \text{ J mol}^{-1} + (685.8 \text{ J mol}^{-1} \text{ K}^{-1})T$$

The value of  $\Delta V_{\text{mS}} = -29.48$  cm $^3$  mol $^{-1}$  and the value of  $\Delta V_{\text{mF}} = 36.14$  cm $^3$  mol $^{-1}$  ( $2\text{H}_2\text{O}$ ). Calculate the ratio of  $P_{\text{S}}$  to  $P_{\text{F}}$  at which  $\Delta G_m(P_{\text{F}}, P_{\text{S}}, T)$  is independent of pressure.

- 13.4.** In Figure 13.6, identify the phases in equilibrium and the curves that describe the composition of each phase in Regions I, II, III, IV, V, VI, VII, and VIII. Identify the phases in equilibrium and the composition of those phases at 260.53 K along line  $BDE$  and at 280.66 K along line  $HGM$ .

## REFERENCES

1. J. Willard Gibbs, *Trans. Conn. Acad. Sci.* **3**, 108–248 (1876); **3**, 343–542 (1878). Reprinted in *The Collected Works of J. Willard Gibbs*, Vol. I, Yale University Press, New Haven, CT, 1957.
2. R. Kern and A. Weisbrod, *Thermodynamics for Geologists*, Freeman, Cooper and Co., San Francisco, CA, 1967.
3. F. P. Bundy, *J. Geophys. Res.* **85B**, 6930 (1980).

4. N. L. Bowen and J. R. Schairer, *Am. J. Sci.* **229**, 151–217 (1935).
5. R. M. Rosenberg, *J. Chem. Educ.* **76**, 223 (1999).
6. G. J. F. McDonald, *Amer. J. Sci.* **251**, 884–898 (1953).
7. J. A. V. Butler, *J. Gen. Physiol.* **24**, 189 (1940); M. Kunitz and J. H. Northrop, *Compt. Rend. Trav. Lab. Carlsberg, Ser. Chim.* **22**, 288 (1938). Adapted from *J. Gen. Physiol.* 1940, **24**, p. 196, by copyright permission of the Rockefeller University Press.
8. M. W. Chase, Jr., C. A. Davies, J. R. Downey, Jr., D. J. Frurip, R. A. McDonald, and A. N. Syverud, JANAF thermochemical tables, 3rd ed., *J. Phys. Chem. Ref. Data* **14**, Supplement No. 1, 1675 (1985).
9. C. Berger, L. Eyraud, M. Richard, and R. Riviere, *Bull. Soc. Chim. France* 628, 1966.
10. R. E. Gibson, *J. Phys. Chem.* **32**, 1197 (1928).



## CHAPTER 14

---

# THE IDEAL SOLUTION

---

In Chapter 13, we discussed multiphase–multicomponent systems in terms of the phase rule and its graphical representation. Now we want to describe the equilibrium curves of a phase diagram in terms of analytic functions, and we begin by considering the ideal solution. Although not many pairs of substances form ideal solutions, we shall find that the relationships that describe an ideal solution provide limiting rules for real solutions and thereby provide a framework for the discussion of real solutions, just as the relationships that describe an ideal gas provide limiting rules for real gases and thereby provide a framework for the discussion of real gases.

### 14.1 DEFINITION

Historically, an ideal solution was defined in terms of a liquid–vapor or solid–vapor equilibrium in which each component in the vapor phase obeys Raoult’s law,

$$p_{i,g} = p_{i,g}^{\bullet} X_{i,\text{cond}} \quad (14.1)$$

where  $p_{i,g}$  is the vapor pressure of component  $i$ ,  $p_{i,g}^{\bullet}$  is the vapor pressure of the pure component  $i$ , and  $X_{i,\text{cond}}$  is the mole fraction of component  $i$  in the condensed phase.



If the vapor does not behave as an ideal gas, the appropriate equation corresponding to Equation (14.1) is

$$f_{i,g} = f_{i,g}^{\bullet} X_{i,\text{cond}} \quad (14.2)$$

a form expressed in fugacities instead of partial pressures. Specifically, the fugacity  $f_{i,g}$  of each component in the gas phase is equal to  $f_{i,g}^{\bullet}$ , the fugacity of the pure vapor in equilibrium with the pure condensed phase at its equilibrium pressure, multiplied by  $X_{i,\text{cond}}$ , the mole fraction of the component in the condensed phase. We should emphasize that the fugacity of the gas in equilibrium with the pure condensed phase at its equilibrium vapor pressure is not equal to the standard fugacity of the gas phase, which is defined in Figure 10.5. For an ideal two-component system, the dependence of the fugacities in the gas phase on the mole fractions in the condensed phase is illustrated in Figure 14.1.

Equation (14.2) clearly reduces to the historical form of Raoult's law [Equation (14.1)] when the vapors are an ideal mixture of ideal gases.

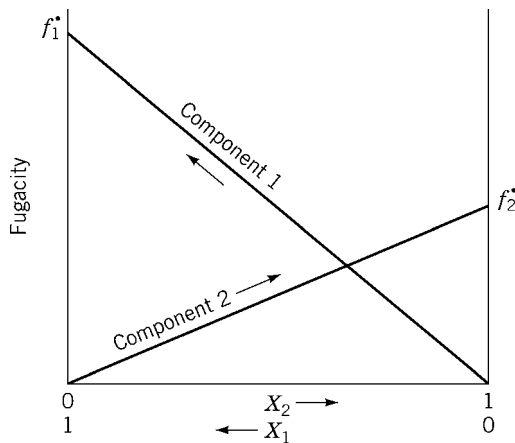
From Equation (10.29),

$$\mu_{i,g}^{\circ} = \mu_{i,g} + RT \ln \frac{f_{i,g}}{f_{i,g}^{\infty}} \quad (14.3)$$

and

$$\mu_{i,g}^{\bullet} = \mu_{i,g}^{\circ} + RT \ln \frac{f_{i,g}^{\bullet}}{f_{i,g}^{\infty}} \quad (14.4)$$

where  $\mu_{i,g}^{\bullet}$  is determined at the same temperature as that of the solution and at the equilibrium vapor pressure of the pure condensed phase, not at the standard pressure



**Figure 14.1.** Dependence of fugacities in the gas phase on the composition of the condensed phase for an ideal solution.

of 1 bar. Therefore, if we substitute for  $\mu^\circ$  from Equation (14.4) into Equation (14.3) we obtain for a vapor in equilibrium with a condensed ideal solution, either solid or liquid,

$$\begin{aligned}\mu_{i,g} &= \mu_{i,g}^\bullet + RT \ln \frac{f_{i,g}}{f_{i,g}^\bullet} \\ &= \mu_{i,g}^\bullet + RT \ln X_{i,\text{cond}}\end{aligned}\quad (14.5)$$

Furthermore, at equilibrium between the phases,

$$\begin{aligned}\mu_{i(\text{cond})} &= \mu_{i,g} \\ &= \mu_{i,g}^\bullet + RT \ln X_{i,\text{cond}} \\ &= \mu_{i,\text{cond}}^\bullet + RT \ln X_{i,\text{cond}}\end{aligned}\quad (14.6)$$

because the pure gas and the pure condensed phases would also be in equilibrium at this temperature and their equilibrium vapor pressure, and their chemical potentials must be equal at equilibrium.

It is convenient, therefore, to choose the pure condensed phase at the temperature of the solution at the *equilibrium vapor pressure* of the pure condensed phase as the standard state for the component in the solution<sup>1</sup> (see Ref. 1). Thus, Equation (14.6) can also be written

$$\mu_{i,\text{cond}} = \mu_{i,\text{cond}}^\circ + RT \ln X_{i,\text{cond}}\quad (14.7)$$

## 14.2 SOME CONSEQUENCES OF THE DEFINITION

If Equation (14.2), Equation (14.6), or Equation (14.7) is used to define an ideal solution of two components, values for the changes in thermodynamic properties resulting from the formation of such a solution follow directly.

### Volume Changes

*No change in volume occurs when pure components that form an ideal solution are mixed.* This statement can be validated for an ideal solution as follows. At any fixed

<sup>1</sup>Two other conventions exist for the choice of standard states for components of a solution. One convention chooses the pure component at 1 bar of pressure, for conformance with the usual standard state for pure components. This choice has the disadvantage that it requires a term for the effect of pressure in the relation between the chemical potentials of the pure component and of the component in solution. The other convention chooses the pure component at the vapor pressure of the solution. This choice has the disadvantage of having different standard states for each composition of solution.

mole fraction, differentiation of Equation (14.6) and Equation (14.7) with respect to pressure yields

$$\left(\frac{\partial \mu_i}{\partial P}\right)_{T, X_i} = \left(\frac{\partial \mu_i^\circ}{\partial P}\right)_T = \left(\frac{\partial \mu_i^\bullet}{\partial P}\right)_T \quad (14.8)$$

But from Equation (9.25), we have

$$\left(\frac{\partial \mu_i}{\partial P}\right)_{T, X_i} = V_{mi}$$

Hence Equation (14.8) becomes

$$V_{mi} = V_{mi}^\bullet \quad (14.9)$$

in which  $V_{mi}^\bullet$  represents the molar volume of pure component  $i$ . Thus, the partial molar volume of each component in solution is equal to the molar volume of the corresponding pure substance.

Before the two pure components are mixed, the total volume  $V_{\text{initial}}$  is

$$V_{\text{initial}} = n_1 V_{m1}^\bullet + n_2 V_{m2}^\bullet \quad (14.10)$$

When the solution is formed, the total volume  $V_{\text{final}}$  is, from Equation (9.27),

$$V_{\text{final}} = n_1 V_{m1} + n_2 V_{m2} \quad (14.11)$$

The volume change on mixing is, therefore,

$$\Delta V = V_{\text{final}} - V_{\text{initial}} = n_1 V_{m1} + n_2 V_{m2} - (n_1 V_{m1}^\bullet + n_2 V_{m2}^\bullet) = 0 \quad (14.12)$$

### Heat Effects

*No heat is evolved when pure components that form an ideal solution are mixed.* The validity of this statement can be shown from consideration of the temperature coefficient of the chemical potential. Again, from Equation (14.6) at fixed mole fraction,

$$\left[\frac{\partial(\mu_i/T)}{\partial T}\right]_{P, X_i} = \left[\frac{\partial(\mu_i^\bullet/T)}{\partial T}\right]_P = \left[\frac{\partial(\mu_i^\circ/T)}{\partial T}\right]_P \quad (14.13)$$

From Section (9.3), we see that thermodynamic relationships for extensive thermodynamic properties also apply to partial molar properties. From Equation (9.57)

$$\left[\frac{\partial(\mu_i/T)}{\partial T}\right]_{P, X_i} = -\frac{H_{mi}}{T^2} \quad (14.14)$$

Thus, Equation (14.13) becomes

$$H_{mi} = H_{mi}^{\bullet} \quad (14.15)$$

in which  $H_{mi}^{\bullet}$  is the molar enthalpy of pure component  $i$ . Before mixing the two components, the enthalpy  $H_{\text{initial}}$  is given by

$$H_{\text{initial}} = n_1 H_{m1}^{\bullet} + n_2 H_{m2}^{\bullet} \quad (14.16)$$

and after the formation of the solution, the enthalpy is

$$H_{\text{final}} = n_1 H_{m1} + n_2 H_{m2} \quad (14.17)$$

Thus, the enthalpy change on mixing is

$$\Delta H = H_{\text{final}} - H_{\text{initial}} = n_1 H_{m1} + n_2 H_{m2} - (n_1 H_{m1}^{\bullet} + n_2 H_{m2}^{\bullet}) = 0 \quad (14.18)$$

As  $\Delta H$  is a measure of the heat exchanged in a constant-pressure process, no heat is evolved or absorbed on mixing an ideal solution.

From Equation (9.21)

$$\left( \frac{\partial H_{mi}}{\partial T} \right)_{P, X_i} = C_{Pmi}$$

and

$$\left( \frac{\partial H_{mi}^{\bullet}}{\partial T} \right)_P = C_{Pmi}^{\bullet} \quad (14.19)$$

Therefore

$$C_{Pmi} = C_{Pmi}^{\bullet} \quad (14.20)$$

for each component of an ideal solution.

### 14.3 THERMODYNAMICS OF TRANSFER OF A COMPONENT FROM ONE IDEAL SOLUTION TO ANOTHER

We can represent the transfer process by the equation

$$\text{component } i(\text{A}) = \text{component } i(\text{A}') \quad (14.21)$$

where A represents one solution and A' represents the other. The thermodynamic properties of the two solutions are shown in Table 14.1.

If we transfer  $dn_i$  moles of component  $i$  from solution A to solution A', we can write from Equation (11.15) that

$$dG_m = \mu_i' dn_i - \mu_i dn_i = (\mu_i' - \mu_i) dn_i \quad (14.22)$$

**TABLE 14.1. Thermodynamic Properties of Two Ideal Solutions (A and A') of Different Mole Fractions,  $X_i$  and  $X'_i$ , Prepared from the Same Components**

Property of Component $i$	A	A'
Mole fraction	$X_i$	$X'_i$
Fugacity	$f_i = f_i^\bullet X_i$	$f'_i = f_i^\bullet X'_i$
Chemical potential	$\mu_i = \mu_i^\circ + RT \ln (f_i/f^\circ)$	$\mu'_i = \mu_i^\circ + RT \ln (f'_i/f^\circ)$
Enthalpy	$H_{mi} = H_{mi}^\bullet$	$H'_{mi} = H_{mi}^\bullet$
Entropy	$S_{mi} = (H_{mi}^\bullet - \mu_i)/T$	$S'_{mi} = (H_{mi}^\bullet - \mu'_i)/T$

or

$$\left(\frac{\partial G_m}{\partial n_i}\right)_{T,P,X_i} = \mu'_i - \mu_i \tag{14.23}$$

Then  $\Delta G_m$  for the transfer process can be obtained by integrating Equation (14.23) from  $n = 0$  to  $n = 1$ . That is,

$$\begin{aligned} \Delta G_m &= G_{m2} - G_{m1} \\ &= \int_0^1 \left(\frac{\partial G_m}{\partial n_i}\right)_{T,P,X_i} dn_i \\ &= \int_0^1 (\mu'_i - \mu_i) dn_i \end{aligned} \tag{14.24}$$

If we assume that the solutions are of large enough volume that the transfer does not change the compositions and chemical potentials, that is the *infinite copy model*, then the integral in Equation (11.24) can be evaluated and

$$\begin{aligned} \Delta G_m &= \mu'_i - \mu_i \\ &= \mu_i^\circ + RT \ln X'_i - [\mu_i^\circ + RT \ln X_i] \\ &= RT \ln \frac{X'_i}{X_i} \end{aligned} \tag{14.25}$$

Furthermore, the enthalpy change is

$$\begin{aligned} \Delta H &= H'_{mi} - H_{mi} \\ &= H_{mi}^\bullet - H_{mi}^\bullet = 0 \end{aligned} \tag{14.26}$$

Similarly, the volume change is

$$\begin{aligned} \Delta V &= V'_{mi} - V_{mi} \\ &= V_{mi}^\bullet - V_{mi}^\bullet = 0 \end{aligned} \tag{14.27}$$

Finally, the entropy change is

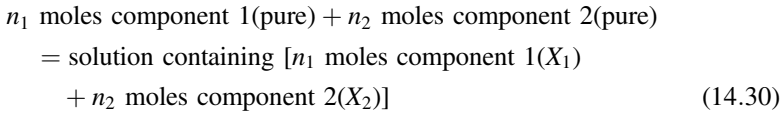
$$\begin{aligned}\Delta S &= S'_{mi} - S_{mi} \\ &= \frac{H^{\bullet}_{mi} - \mu'_i}{T} - \frac{H^{\bullet}_{mi} - \mu_i}{T} \\ &= -\frac{\mu'_i - \mu_i}{T}\end{aligned}\quad (14.28)$$

and from Equation (14.7) and Equation (14.28)

$$\Delta S = -R \ln \frac{X'_i}{X_i} \quad (14.29)$$

#### 14.4 THERMODYNAMICS OF MIXING

In a similar way we can consider an integral mixing process for the formation of an ideal solution from the components, as illustrated in Figure 14.2. The mixing process can be represented by the equation



Thus,

$$\begin{aligned}\Delta J &= J_{\text{final}} - J_{\text{initial}} \\ &= n_1 J_{m1} + n_2 J_{m2} - n_1 J^{\bullet}_{m1} - n_2 J^{\bullet}_{m2}\end{aligned}\quad (14.31)$$

Then the change in the Gibbs function is

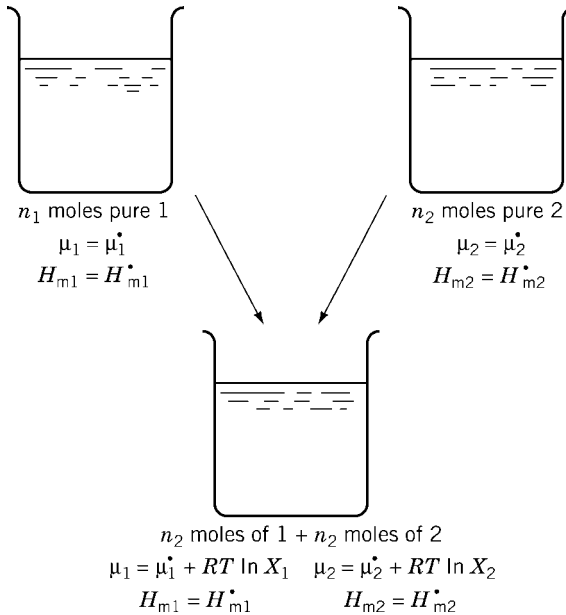
$$\begin{aligned}\Delta G &= n_1 \mu_1 + n_2 \mu_2 - n_1 \mu^{\bullet}_1 - n_2 \mu^{\bullet}_2 \\ &= n_1 [\mu_1^{\circ} + RT \ln X_1 - \mu^{\bullet}_1] + n_2 [\mu_2^{\circ} + RT \ln X_2 - \mu^{\bullet}_2] \\ &= n_1 RT \ln X_1 + n_2 RT \ln X_2\end{aligned}\quad (14.32)$$

because  $\mu^{\bullet}_1 = \mu^{\circ}_1$  and  $\mu^{\bullet}_2 = \mu^{\circ}_2$ .

For the enthalpy change

$$\begin{aligned}\Delta H &= n_1 H_{m1} + n_2 H_{m2} - n_1 H^{\bullet}_{m1} - n_2 H^{\bullet}_{m2} \\ &= 0\end{aligned}\quad (14.33)$$

because  $H_{mi} = H^{\bullet}_{mi}$ .



**Figure 14.2.** Thermodynamics of formation of ideal solution from pure components.

As, for an isothermal change, from Equation (7.26)

$$\Delta S = \frac{\Delta H - \Delta G}{T}$$

then

$$\begin{aligned} \Delta S &= -\frac{\Delta G}{T} \\ &= -n_1 R \ln X_1 - n_2 R \ln X_2 \end{aligned} \tag{14.34}$$

The values for the formation of an ideal solution are identical with those we derived for mixing ideal gases in Chapter 10. Thus, a mixture of ideal gases is a special case of an ideal solution. The equations that we have derived are equally applicable to solid, liquid, and gaseous solutions as long as no phase change occurs in the mixing process. For the special case when  $n_1 + n_2 = 1$ , the thermodynamic changes are

$$\begin{aligned} \Delta G_m &= \frac{n_1 RT \ln X_1 + n_2 RT \ln X_2}{n_1 + n_2} \\ &= X_1 RT \ln X_1 + X_2 RT \ln X_2 \end{aligned} \tag{14.35}$$

$$\Delta H_m = 0 \tag{14.36}$$

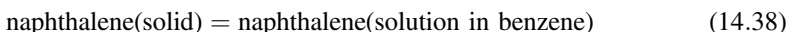
and

$$\Delta S_m = -X_1 R \ln X_1 - X_2 R \ln X_2 \quad (14.37)$$

## 14.5 EQUILIBRIUM BETWEEN A PURE SOLID AND AN IDEAL LIQUID SOLUTION

For some ideal solutions, the range of composition that can be attained is limited because of the limited solubility of one or both components. As an example, let us consider the solution of naphthalene in benzene.

When  $\Delta H$  is measured for the change



it is found that  $\Delta H_m$  is equal to  $\Delta H_{m,f}$  of naphthalene, where the subscript f refers to fusion. Therefore, it is reasonable to consider that dissolved naphthalene can be regarded as being in the liquid state rather than in the solid state. If we examine the process



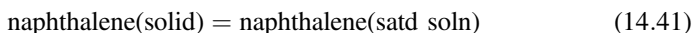
we find the accompanying heat effect is zero. Clearly this result is consistent with the observation that dissolved naphthalene behaves as if it were a liquid in an ideal solution. The liquid is called supercooled because the temperature is below the melting point of naphthalene.

If the solution is ideal, the chemical potential  $\mu_2$  of the dissolved solute at a fixed temperature and pressure is given by the expression [from Equations (14.6) and (14.7)]

$$\begin{aligned} \mu_2 &= \mu_2^\circ + RT \ln X_2 \\ &= \mu_2^\bullet + RT \ln X_2 \end{aligned} \quad (14.40)$$

in which  $\mu_2^\bullet$  is the chemical potential of the *pure, supercooled, liquid naphthalene*. This dissolved solute is characterized also by the molar volume and enthalpy,  $V_{m2}^\bullet$  and  $H_{m2}^\bullet$ , respectively, that are equal to the corresponding quantities for the pure, supercooled, liquid naphthalene.

Above a specified concentration (at a given temperature and pressure) no more naphthalene will dissolve at equilibrium; that is, the solution becomes saturated. When solid naphthalene is in equilibrium with the solution, as in Equation (14.41),



it follows that

$$\begin{aligned} \mu_{2,\text{solid}} &= \mu_{2,\text{satd soln}} \\ &= \mu_2^\bullet + RT \ln X_{2,\text{satd soln}} \end{aligned} \quad (14.42)$$



Clearly,

$$\mu_{2,\text{solid}} < \mu_2^\bullet \quad (14.43)$$

because we know that supercooled, liquid naphthalene can be transformed spontaneously into the solid, and because  $X_{2,\text{satd soln}}$  in Equation (14.42) is always less than one; in other words, the escaping tendency of the supercooled liquid is greater than that of the solid. By rearranging Equation (14.42), we obtain

$$\ln X_{2,\text{satd soln}} = \frac{\mu_{2,\text{solid}} - \mu_2^\bullet}{RT} \quad (14.44)$$

or

$$X_{2,\text{satd soln}} = \exp \left[ \frac{\mu_{2,\text{solid}} - \mu_2^\bullet}{RT} \right] \quad (14.45)$$

In this equation,  $X_2$  represents the mole fraction of naphthalene *in the saturated solution in benzene*. It is determined only by the chemical potential of solid naphthalene and of pure, supercooled liquid naphthalene. No property of the solvent (benzene) appears in Equation (14.45). Thus, we arrive at the conclusion that the solubility of naphthalene (in terms of mole fraction) is the same in all solvents with which it forms an ideal solution. Furthermore, nothing in the derivation of Equation (14.45) restricts its application to naphthalene. Hence, the *solubility* (in terms of mole fraction) of any specified solid is *the same in all solvents with which it forms an ideal solution*.

### Change of Solubility with Pressure at a Fixed Temperature

When a solid is in equilibrium with the solute in an ideal solution under isothermal conditions:

$$\text{solid} = \text{solute in solution} \quad (14.46)$$

then

$$\mu_{2,\text{solid}} = \mu_{2,\text{satd soln}} \quad (14.47)$$

If the pressure is changed, the solubility can change, but if equilibrium is maintained, then

$$d\mu_{2,\text{solid}} = d\mu_{2,\text{satd soln}} \quad (14.48)$$

The chemical potential of the solid is a function only of the pressure at constant temperature, whereas the chemical potential of the solute in the saturated solution

is a function of both pressure and mole fraction. Thus,

$$\begin{aligned} d\mu_{2,\text{solid}} &= \left( \frac{\partial \mu_{2,\text{solid}}}{\partial P} \right)_T dP \\ &= d\mu_{2,\text{satd soln}} = \left( \frac{\partial \mu_{2,\text{satd soln}}}{\partial P} \right)_{T,X_2} dP + \left( \frac{\partial \mu_{2,\text{satd soln}}}{\partial X_2} \right)_{T,P} dX_2 \end{aligned} \quad (14.49)$$

From Equation (9.25) and Equation (14.9)

$$\left( \frac{\partial \mu_{2,\text{solid}}}{\partial P} \right)_T = V_{\text{m}2,\text{solid}} \quad \text{and} \quad \left( \frac{\partial \mu_{2,\text{satd soln}}}{\partial P} \right)_{T,X_2} = V_{\text{m}2,\text{satd soln}} = V_{\text{m}2}^{\bullet} \quad (14.50)$$

and, from Equation (14.6),

$$\left( \frac{\partial \mu_{2,\text{satd}}}{\partial X_2} \right)_{T,P} = \frac{RT}{X_2} \quad (14.51)$$

Substituting from Equations (14.50) and (14.51) into Equation (14.49), we obtain

$$V_{\text{m}2,\text{solid}} dP = V_{\text{m}2}^{\bullet} dP + RT \frac{dX_2}{X_2} \quad (14.52)$$

or

$$\frac{dX_2}{X_2} = d \ln X_2 = \frac{V_{\text{m}2,\text{solid}} - V_{\text{m}2}^{\bullet}}{RT} dP \quad (14.53)$$

Rearranging we obtain

$$\left[ \frac{\partial \ln X_{2,\text{satd}}}{\partial P} \right]_T = \frac{V_{\text{m}2,\text{solid}} - V_{\text{m}2}^{\bullet}}{RT} \quad (14.54)$$

in which we recognize explicitly that  $X_2$  is the mole fraction of solute in the saturated solution.

As  $V_{\text{m}2}^{\bullet}$  is the molar volume of pure, supercooled solute, Equation (14.54) can be written as

$$\left[ \frac{\partial \ln X_{2,\text{satd}}}{\partial P} \right]_T = - \frac{\Delta_f V_{\text{m}2}}{RT} \quad (14.55)$$

In this case,  $\Delta_f V_{\text{m}2}$  is the molar volume change for the transition from the pure, solid solute to the supercooled, liquid solute; that is, fusion.

### Change of Solubility with Temperature

The procedure for deriving the temperature coefficient of the solubility of a solute in an ideal solution parallels that just used for the pressure coefficient. The condition for maintenance of equilibrium with a change in temperature is still Equation (14.48).

As at constant pressure the chemical potential of the pure solid is a function only of the temperature, and the chemical potential of the solute is a function of the temperature and mole fraction, we can express Equation (14.48) as

$$\left(\frac{\partial \mu_{2,\text{solid}}}{\partial T}\right)_P dT = \left(\frac{\partial \mu_{2,\text{satd soln}}}{\partial T}\right)_{P,X_2} dT + \left(\frac{\partial \mu_{2,\text{satd soln}}}{\partial X_2}\right)_{P,T} dX_2 \quad (14.56)$$

From Equation (9.24), we have

$$\left(\frac{\partial \mu_{2,\text{solid}}}{\partial T}\right)_P = -S_{m2,\text{solid}} \quad \text{and} \quad \left(\frac{\partial \mu_{2,\text{satd soln}}}{\partial T}\right)_{P,X_2} = -S_{m2,\text{satd soln}} \quad (14.57)$$

and from Equation (14.6)

$$\left(\frac{\partial \mu_{2(\text{satd})}}{\partial X_2}\right)_{T,P} = \frac{RT}{X_2} \quad (14.58)$$

Consequently, Equation (14.56) becomes

$$-S_{m2,\text{solid}} dT = -S_{m2,\text{satd soln}} dT + \frac{RT}{X_2} dX_2 \quad (14.59)$$

or

$$d \ln X_2 = \frac{S_{m2,\text{satd}} - S_{m2,\text{solid}}}{RT} dT \quad (14.60)$$

and

$$\left[\frac{d \ln X_{2,\text{satd}}}{dT}\right]_P = \frac{S_{m2,\text{satd}} - S_{m2,\text{solid}}}{RT} \quad (14.61)$$

From Table 14.1, as  $\mu_{2(\text{satd})} = \mu_{2(\text{solid})}$  at equilibrium,

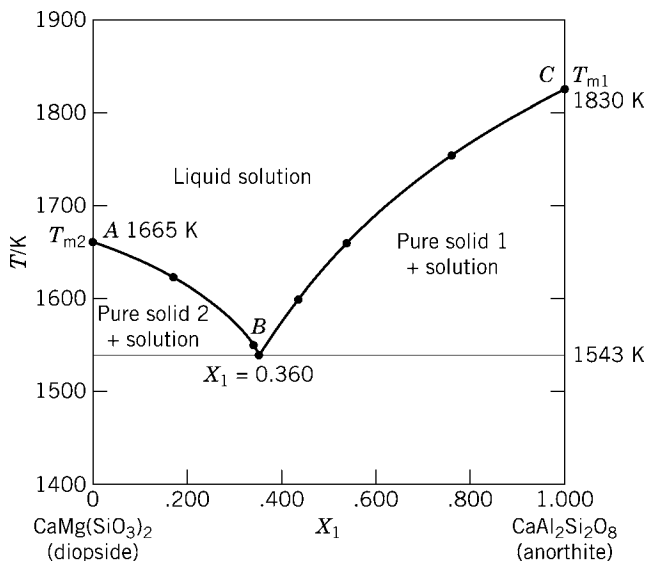
$$\begin{aligned} S_{m2,\text{satd}} - S_{m2,\text{solid}} &= \frac{H_{m2,\text{satd}} - H_{m2,\text{solid}}}{T} \\ &= \frac{H_{m2}^* - H_{m2,\text{solid}}}{T} \end{aligned} \quad (14.62)$$

Thus, Equation (14.61) can be written as

$$\left[\frac{\partial \ln X_{2,\text{satd}}}{\partial T}\right]_P = \frac{\Delta_f H_{m2}}{RT^2} \quad (14.63)$$

and  $\Delta_f H_{m2}$  is the molar enthalpy change for the transition from pure, solid solute to pure, supercooled, liquid solute (i.e., fusion).

As  $T$  is the temperature at which a liquid solution is in equilibrium with a pure, solid solute, one also can interpret Equation (14.63) as describing the way in



**Figure 14.3.** The reduced phase diagram at constant pressure for the two-component system diopside–anorthite, in which the pure solids are completely insoluble in each other. Data from N. L. Bowen, *Am. J. Sci. Ser. 4*, **40**, 161 (1915).

which the freezing point of the solution depends on concentration; from this point of view, component 2 is the solvent. This interpretation is shown explicitly by inverting the derivative:

$$\left[ \frac{\partial T_m}{\partial \ln X_2} \right]_p = \frac{RT_m^2}{\Delta_f H_{m2}} \quad (14.64)$$

The interpretation of Equations (14.63) and (14.64) can be illustrated graphically by the reduced-phase diagram for a two-component system at constant pressure, as shown for the system diopside-anorthite in Figure 14.3.

As we pointed out in Chapter 13, each of the two-phase regions has one degree of freedom, and the equilibrium relationship between  $T$  and  $X$  is given by curves  $AB$  or  $BC$  when component 2 or component 1, respectively, is in higher concentration. In the region below the horizontal line, only the temperature can vary because both phases are pure solids.

The equation of curve  $AB$  can be obtained by integrating Equation (14.64), and the equation of curve  $BC$  can be obtained by integrating the corresponding equation:

$$\left( \frac{\partial T_m}{\partial \ln X_1} \right)_p = \frac{RT_m^2}{\Delta_f H_{m1}} \quad (14.65)$$

in which  $\Delta H_{m,f,1}$  is the molar enthalpy for the transition from pure, solid component 1 to pure, supercooled, liquid component 1.

## 14.6 EQUILIBRIUM BETWEEN AN IDEAL SOLID SOLUTION AND AN IDEAL LIQUID SOLUTION

In Chapter 13 we discussed briefly the solid–liquid equilibrium diagram of a feldspar. Feldspar is an ideal, solid solution of albite ( $\text{NaAlSi}_3\text{O}_8$ ) and anorthite ( $\text{CaAlSi}_2\text{O}_8$ ) in the solid state as well as an ideal, liquid solution of the same components in the molten state. The relationships that we have developed in this chapter permit us to interpret the feldspar phase diagram (Figure 13.4) in a quantitative way.

### Composition of the Two Phases in Equilibrium

Let us designate albite as component 1 and anorthite as component 2. According to Equations (14.6) and (14.7), we can write for each component in each phase

$$\mu_{i,s} = \mu_{i,s}^\circ + RT \ln X_{i,s} = \mu_{i,s}^\bullet + RT \ln X_{i,s} \quad (14.66)$$

$$\mu_{i,l} = \mu_{i,l}^\circ + RT \ln X_{i,l} = \mu_{i,l}^\bullet + RT \ln X_{i,l} \quad (14.67)$$

At equilibrium at constant temperature and pressure, the chemical potential of each component must be the same in both phases. That is

$$\mu_{i,s} = \mu_{i,l} \quad (14.68)$$

If we substitute from Equations (14.66) and (14.67) into Equation (14.68), we obtain

$$\ln \frac{X_{i,l}}{X_{i,s}} = \frac{\mu_{i,s}^\bullet - \mu_{i,l}^\bullet}{RT} \quad (14.69)$$

The two equations of the form of Equation (14.69), together with the restrictions that  $X_{1,s} + X_{2,s} = 1$  and  $X_{1,l} + X_{2,l} = 1$ , uniquely determine the compositions of the two phases in equilibrium at any temperature at a fixed pressure. As the temperature interval in which solid and liquid phases can be in equilibrium is between the melting points of the pure components (see Figure 13.4), one component is above its melting point and one is below its melting point. For the component above its melting point

$$\mu_s^\bullet > \mu_l^\bullet \quad (14.70)$$

and therefore

$$X_{\text{solid solution}} < X_{\text{liquid solution}} \quad (14.71)$$

The opposite is true for the other component.

### Temperature Dependence of the Equilibrium Compositions

If the equilibrium is to be maintained as the temperature is changed at constant pressure, then, from Equation (14.68), we conclude that

$$d\mu_{i,l} = d\mu_{i,s} \quad (14.72)$$

for each component. As  $\mu_i$  is a function of temperature and composition, Equation (14.72) becomes

$$\left[ \frac{\partial \mu_{i,s}}{\partial T} \right]_{P, X_i} dT + \left[ \frac{\partial \mu_{i,s}}{\partial X_{i,s}} \right]_{T, P} dX_{i,s} = \left[ \frac{\partial \mu_{i,l}}{\partial T} \right]_{P, X_i} dT + \left[ \frac{\partial \mu_{i,l}}{\partial X_{i,l}} \right]_{T, P} dX_{i,l} \quad (14.73)$$

If we substitute the appropriate expressions for the partial derivatives in Equation (14.73), we obtain

$$-S_{m_i,s} dT + \frac{RT}{X_{i,s}} dX_{i,s} = -S_{m_i,l} dT + \frac{RT}{X_{i,l}} dX_{i,l} \quad (14.74)$$

If we rearrange terms in Equation (14.74), we obtain

$$\frac{dX_{i,s}}{X_{i,s}} - \frac{dX_{i,l}}{X_{i,l}} = \frac{S_{m_i,s} - S_{m_i,l}}{RT} dT \quad (14.75)$$

As in Equation (14.62), we can conclude that

$$\begin{aligned} S_{m_i,s} - S_{m_i,l} &= \frac{H_{m_i,s} - H_{m_i,l}}{T} \\ &= \frac{H_{m_i,s}^\bullet - H_{m_i,l}^\bullet}{T} \end{aligned} \quad (14.76)$$

and Equation (14.75) becomes

$$d \ln \frac{X_{i,s}}{X_{i,l}} = - \frac{\Delta_f H_{m_i}}{RT^2} dT \quad (14.77)$$

The integration of Equation (14.77) for each of the two components leads to the temperature-composition curves of the solid and liquid phases.

Silverman [2] has presented an analogous analysis of the vapor-liquid equilibrium for an ideal solution.

## EXERCISES

- 14.1. a.** Calculate  $\Delta G_m$ ,  $\Delta H_m$ , and  $\Delta S_m$  (per mole of benzene) at 298 K for the addition of an infinitesimal quantity of pure benzene to 1 mole of an ideal solution of benzene and toluene in which the mole fraction of the latter is 0.6.

- b. Calculate  $\Delta G_m$ ,  $\Delta H_m$ , and  $\Delta S_m$  (per mole of benzene) at 298 K for the mixing of 0.4 mole of pure benzene with 0.6 mole of pure toluene to form an ideal solution.
- 14.2. Calculate the entropy (per mole of mixture) of “unmixing”  $^{235}\text{U}$  and  $^{238}\text{U}$  from a sample of pure uranium from natural sources. The former isotope occurs to the extent of 0.7 mole % in the natural (ideal) mixture.
- 14.3. For the mixing of two pure components to form 1 mole of an ideal solution,  $\Delta G_{m,\text{mixing}}$  is given by Equation (14.35).
- Plot  $\Delta G_{m,\text{mixing}}$  as a function of  $X_2$ .
  - Prove analytically, from Equation (14.35), that the curve in (a) has a minimum at  $X_2 = 0.5$ .
- 14.4. Suppose that a pure gas dissolves in some liquid solvent to produce an ideal solution. Show that the solubility of this gas must fit the following relationships:

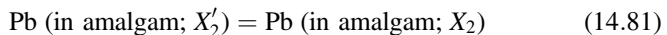
$$\text{a. } \left( \frac{\partial \ln X_{2,\text{satd}}}{\partial P} \right)_T = \frac{V_{m2,g} - V_{m2}}{RT} \quad (14.78)$$

$$\text{b. } \left( \frac{\partial \ln X_{2,\text{satd}}}{\partial T} \right)_P = - \frac{\Delta H_{m,v} \text{ solute}}{RT^2} \quad (14.79)$$

$$\text{c. } \ln X_{2,\text{satd}} = \frac{\Delta H_{m,v}}{R} \left( \frac{1}{T} - \frac{1}{T_{\text{bp}}} \right) \quad (14.80)$$

in which  $T_{\text{bp}}$  is the boiling point of the pure solute and  $\Delta H_{m,v}$  is the enthalpy of vaporization of the pure solvent.

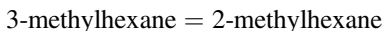
- 14.5. If two lead amalgam electrodes of different compositions ( $X_2$  and  $X'_2$ ) are prepared and immersed in a suitable electrolyte, an electrical cell is obtained in which the following transfer process occurs when the cell is discharged:



For a particular cell, operated at 27°C and 1 bar,  $X'_2 = 0.000625$  and  $X_2 = 0.0165$ . Assume that Pb and Hg form ideal solutions in this concentration range.

- Calculate  $\Delta G_m$  for the reaction if the cell is discharged reversibly.
- Calculate  $\Delta G_m$  for the reaction if the cell is short-circuited so that no electrical work is performed.
- What is  $\Delta H_m$  for the reaction carried out under the conditions in (a)?
- What is  $\Delta S_m$  for the reaction carried out under the conditions in (a)?
- What is  $Q_m$  for the reaction carried out under the conditions in (a)?
- What is  $Q_m$  for the reaction carried out under the conditions in (b)?

**14.6.** Maury et al. [3] published data for the equilibrium



$\Delta G_m^\circ$  (pure liquid is the standard state for each substance) is  $-1194 \text{ J mol}^{-1}$  at  $0^\circ\text{C}$ . In a solution containing only the two isomers, equilibrium is attained when the mole fraction of the 3-methylhexane is 0.372. Is the equilibrium solution ideal? Show the computations on which your answer is based.

**14.7.** Integrate Equations (14.64) and (14.65) from some point  $X$ ,  $T$  to  $X = 1$ ,  $T_m = T_m(\text{pure})$ , assuming that  $\Delta H_{m,f}$  is constant throughout the temperature range. The melting points of pure naphthalene and pure benzene are  $80.2^\circ\text{C}$  and  $5.4^\circ\text{C}$ , respectively. The average enthalpies of fusion of naphthalene and benzene in the temperature range are 10,040 and 19,200  $\text{J mol}^{-1}$ , respectively. Calculate the temperature and composition for the naphthalene–benzene system that correspond to point  $B$ , the eutectic point, in Figure 14.3.

**14.8. a.**  $\text{RuO}_4$  and  $\text{OsO}_4$  are completely miscible in the solid and liquid states. Koda [4] and Nisel'son et al. [5] showed that the solid and liquid phases in equilibrium are of the same composition over the complete range of compositions and that the mole-fraction temperature curve is linear. Show from Equation (14.77) that the solid solutions are not ideal.

**b.** Koda also showed that the boiling points of both compounds are identical within experimental error, and that the boiling point–mole fraction curve is horizontal over the whole range of compositions. Silverman [2] showed that the equation for the boiling point curve for an ideal solution follows the equation

$$(1 - X_2)e^{[-\Delta_v H_{m1}(\frac{1}{T} - \frac{1}{T_{B1}})]/R} + X_2e^{[-\Delta_v H_{m2}(\frac{1}{T} - \frac{1}{T_{B2}})]/R} = 1 \quad (14.82)$$

Show that the experimental data for the boiling point curve for this solution is compatible with Equation (14.82).

## REFERENCES

1. K. Denbigh, *The Principles of Chemical Equilibrium*, 3rd ed., Cambridge University Press, Cambridge, 1971, pp. 270–271; K. S. Pitzer and L. Brewer, *Thermodynamics*, 2nd ed., McGraw-Hill Book Co., New York, 1961, pp. 245–246.
2. M. P. Silverman, *J. Chem. Educ.* **62**, 112 (1985).
3. L. G. Maury, R. L. Burwell, and R. H. Tuxworth *J. Am. Chem. Soc.* **76**, 5831 (1954).
4. Y. Koda, *J. Chem. Soc. Chem. Commun.* 1347–1348 (1986).
5. L. A. Nisel'son, T. D. Sokolova, A. M. Orlov, and Y. S. Shorikov, *Russian J. Inorg. Chem.* **26**, 412–413 (1981).





## CHAPTER 15

---

# DILUTE SOLUTIONS OF NONELECTROLYTES

---

We will proceed in our discussion of solutions from ideal to nonideal solutions, limiting ourselves at first to nonelectrolytes. For dilute solutions of nonelectrolyte, several limiting laws have been found to describe the behavior of these systems with increasing precision as infinite dilution is approached. If we take any one of them as an empirical rule, we can derive the others from it on the basis of thermodynamic principles.

### 15.1 HENRY'S LAW

The empirical description of dilute solutions that we take as the starting point of our discussion is Henry's law. Recognizing that when the vapor phase is in equilibrium with the solution,  $\mu_2$  in the condensed phase is equal to  $\mu_{2,g}$ , we can state this law as follows: For dilute solutions of a nondissociating solute at constant temperature, the fugacity of the solute in the gas phase is proportional to its mole fraction in the condensed phase: That is,

$$f_{2,g} = k_2 X_{2,\text{cond}} \quad (15.1)$$

This generalized statement of Henry's law originally was expressed in terms of vapor pressure instead of fugacity. As solutions become more and more dilute, this law

becomes increasingly more accurate. We can indicate the limiting nature of Henry's law explicitly by writing it as

$$\lim_{x_2 \rightarrow 0} \frac{f_{2,g}}{X_{2,\text{cond}}} = k_2 \quad (15.2)$$

The difference between Raoult's law [Equation (14.2)] and Henry's law lies in the proportionality constant relating the fugacity to the mole fraction. For Raoult's law, this constant is  $f_{2,g}^\circ$ , the fugacity of the vapor in equilibrium with the pure solute. Generally, however, for Henry's law,

$$k_2 \neq f_{2,g}^\circ \quad (15.3)$$

This distinction can be made clearer by a graphical illustration (Fig. 15.1). A typical fugacity-mole fraction curve is shown by the solid line. If the solute formed an ideal solution with the solvent, the fugacity of the solute would be represented by the broken line (Raoult's law). The actual behavior of the solute does not approach Raoult's law, except when its mole fraction approaches 1 (that is, under circumstances when it no longer would be called the solute). When the solute is present in small quantities, its fugacity deviates widely from Raoult's law. However, as  $X_2$  approaches 0, the fugacity does approach a linear dependence on  $X_2$ . This limiting linear relationship, which is a graphical illustration of Henry's law, is represented by the dotted line in Figure 15.1.<sup>1</sup>

When a solution obeys Henry's law, the expression for the chemical potential [from Equation (10.29) and Equation (15.1)] is

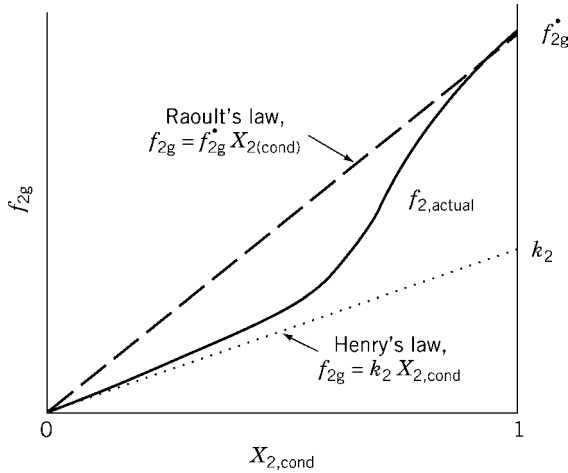
$$\begin{aligned} \mu_2 &= \mu_{2,g} = \mu_{2,g}^\circ + RT \ln \left( \frac{f_{2,g}}{f_g^\circ} \right) \\ &= \mu_{2,g}^\circ + RT \ln \left( \frac{k_2 X_2}{f_g^\circ} \right) \\ &= \mu_{2,g}^\circ + RT \ln \left( \frac{k_2}{f_g^\circ} \right) + RT \ln X_2 \end{aligned} \quad (15.4)$$

If we define the first two terms on the right-hand side of Equation (15.4) as  $\mu_2^\circ$ , the standard chemical potential of the solute in solution, then

$$\mu_2 = \mu_2^\circ + RT \ln X_2 \quad (15.5)$$

and the standard state is a *hypothetical* standard state of unit mole fraction of solute, one at the point of *extrapolation* of Henry's law behavior to  $X_2 = 1$ . This assignment

<sup>1</sup>As discussed in Chapters 16 and 17, many solutions do not exhibit a linear behavior in dilute solution, but they do show a finite limit of  $f_2/X_2$  as  $X_2 \rightarrow 0$ .



**Figure 15.1.** Distinction between Henry's law and Raoult's law.

of the standard state can also be observed from Figure 15.1, where  $k_2$  represents the fugacity of the gas in equilibrium with the solute in solution in its hypothetical standard state.

If mole fraction is not a convenient unit of composition, Henry's law can be stated in other units. As the law applies primarily to very dilute solutions

$$X_2 = \frac{n_2}{n_1 + n_2} \cong \frac{n_2}{n_1} \quad (15.6)$$

in which  $n_2$  is the number of moles of solute and  $n_1$  is the number of moles of solvent. Consequently Equation (15.1) can be revised to the form

$$f_{2,g} = k'_2 \left( \frac{n_2}{n_1} \right) = k''_2 \left( \frac{m_2}{m_2^\circ} \right) \quad (15.7)$$

where  $m_2$  is the number of moles of solute dissolved in 1 kilogram of solvent ( $n_1$  moles) and the ratio of molalities is used to keep the dimensions of  $k''_2$  the same as those of  $k'_2$ , and  $m_2$ , the molality, is the number of moles of solute per unit mass of solvent, usually the kilogram. Even when Equation (15.1) is valid throughout a wide range of composition, Equations (15.6) and (15.7) are still approximate. In limiting-law form, Equation (15.7) becomes

$$\lim_{m_2 \rightarrow 0} \frac{f_{2,g}}{m_2/m_2^\circ} = k''_2 \quad (15.8)$$

From Equation (10.29) and Equation (15.7), the chemical potential can be expressed as a function of molality:

$$\begin{aligned}\mu_2 &= \mu_{2,g}^\circ + RT \ln \left( \frac{f_{2,g}}{f_g^\circ} \right) \\ &= \mu_{2,g}^\circ + RT \ln \left[ \frac{k_2'' m_2 / m_2^\circ}{f_g^\circ} \right]\end{aligned}\quad (15.9)$$

We can define the standard chemical potential of the solute in solution as

$$\mu_2^\circ = \mu_{2,g}^\circ + RT \ln \left( \frac{k_2''}{f_g^\circ} \right)\quad (15.10)$$

Thus,

$$\mu_2 = \mu_2^\circ + RT \ln \left( \frac{m_2}{m_2^\circ} \right)\quad (15.11)$$

In Equation (15.11), the choice of  $m_2^\circ$  is entirely arbitrary. However, it is conventional to choose  $m_2^\circ = 1 \text{ mol kg}^{-1}$ ; that is, the standard state of the solute is a *hypothetical* one molal state that is the point of extrapolation of Henry's law behavior to a molality of  $1 \text{ mol kg}^{-1}$ . In a figure analogous to Figure 15.1, but with  $m_2$  along the horizontal axis, the standard state would be a point on the Henry's law dotted line directly above  $m_2 = 1 \text{ mol kg}^{-1}$ .

For solutions obeying Henry's law, as for ideal solutions, and for solutions of ideal gases, the chemical potential is a linear function of the logarithm of the composition variable, and the standard chemical potential depends on the choice of composition variable. The chemical potential is, of course, independent of our choice of standard state and composition measure.

## 15.2 NERNST'S DISTRIBUTION LAW

If a quantity of a solute A is distributed between two immiscible solvents, for example  $I_2$  between carbon tetrachloride and water, then at equilibrium the chemical potentials or escaping tendencies of the solute are the same in both phases; thus, for

$$A(\text{in solvent a}) = A(\text{in solvent b})$$

$$\mu_2 = \mu_2'\quad (15.12)$$

If the chemical potential is expressed in terms of mole fraction

$$\mu_2^\circ + RT \ln X_2 = \mu_2'^\circ + RT \ln X_2'\quad (15.13)$$

Equation (15.13) can describe either an ideal solution [see Equation (14.7)] or a solution sufficiently dilute that Henry's law is followed [see Equation (15.5)]. In either case, it follows that

$$\ln \frac{X_2}{X_2'} = -\frac{\mu_2^\circ - \mu_2^{\circ'}}{RT} \quad (15.14)$$

and

$$\begin{aligned} \frac{X_2}{X_2'} &= \exp\left[-\frac{\mu_2^\circ - \mu_2^{\circ'}}{RT}\right] \\ &= \kappa \end{aligned} \quad (15.15)$$

The value of  $\kappa$  is constant because the standard chemical potentials in the two solvents are constants at a fixed temperature. Nernst's distribution law also can be stated in terms of molality,

$$\frac{m_2}{m_2'} = \kappa' \quad (15.16)$$

if  $m_2^\circ = m_2^{\circ'}$ , that is, if the same standard state is chosen for both solvents. Again  $\kappa'$  is a constant, but it differs in magnitude from  $\kappa$ . Equation (15.16) is valid only for low molalities, even for ideal solutions, as can be observed from Equation (15.6).

### 15.3 RAOULT'S LAW

We can show that if the solute obeys Henry's law in very dilute solutions, the solvent follows Raoult's law in the same solutions. Let us start from the Gibbs–Duhem Equation (9.34), which relates changes in the chemical potential of the solute to changes in the chemical potential of the solvent; that is, for a two-component system

$$n_1 d\mu_1 + n_2 d\mu_2 = 0$$

If Equation (9.34) is divided by  $n_1 + n_2$ , we obtain

$$X_1 d\mu_1 + X_2 d\mu_2 = 0 \quad (15.17)$$

or

$$X_1 \frac{\partial \mu_1}{\partial X_1} + X_2 \frac{\partial \mu_2}{\partial X_1} = 0 \quad (15.18)$$

As, for a two-component system,

$$X_1 + X_2 = 1$$

and

$$dX_1 = -dX_2$$

Equation (15.18) can be rewritten as

$$X_1 \frac{\partial \mu_1}{\partial X_1} - X_2 \frac{\partial \mu_2}{\partial X_2} = 0 \quad (15.19)$$

or alternatively, with the constancy of temperature and pressure explicitly indicated, as

$$\left( \frac{\partial \mu_1}{\partial \ln X_1} \right)_{T,P} = \left( \frac{\partial \mu_2}{\partial \ln X_2} \right)_{T,P} \quad (15.20)$$

Let us apply Equation (15.20), which is a general relationship for any two-component system, to a solution for which Henry's law describes the behavior of the solute. From Equation (15.5),

$$\left( \frac{\partial \mu_2}{\partial \ln X_2} \right)_{T,P} = RT \quad (15.21)$$

Thus, from Equation (15.20) and Equation (15.21)

$$\left( \frac{\partial \mu_1}{\partial \ln X_1} \right)_{T,P} = RT \quad (15.22)$$

Integration of Equation (15.22) at constant  $T$ ,  $P$  leads to

$$\int \left( \frac{\partial \mu_1}{\partial \ln X_1} \right)_{T,P} d \ln X_1 = RT \int d \ln X_1 \quad (15.23)$$

or

$$\mu_1 = RT \ln X_1 + C \quad (15.24)$$

in which  $C$  is a constant of integration. For the solvent at  $X_1 = 1$ ,  $\mu_1 = \mu_1^\bullet = \mu_1^\circ = C$ , and hence, Equation (15.24) becomes

$$\begin{aligned} \mu_1 &= \mu_1^\bullet + RT \ln X_1 \\ &= \mu_1^\circ + RT \ln X_1 \end{aligned}$$

These equations are the same as Equation (14.6) and Equation (14.7), statements of Raoult's law; thus, the solvent obeys Raoult's law when the solute obeys Henry's law. As Henry's law is a limiting law for the solute in dilute solution, Raoult's law

for the solvent in the same solution is also a limiting law. We can express this limiting law in terms of the fugacity by rearranging Equation (14.2) to read as

$$\lim_{x_1 \rightarrow 1} \frac{f_1}{X_1} = f_1^* \tag{15.25}$$

This behavior of a two-component mixture is illustrated in Figure 15.2, which shows the actual fugacity, the values calculated from Henry's law, and the values calculated from Raoult's law, as a function of mole fraction.

We can also show that Raoult's law implies Henry's law by applying the Gibbs–Duhem equation to Raoult's law. From Equation (14.6) and Equation (14.7), we conclude that [compare with Equation (15.21)]

$$\left( \frac{\partial \mu_1}{\partial \ln X_1} \right)_{T,P} = RT$$

From the Gibbs–Duhem equation [Equation (9.34)] we obtained above [Equation (15.20)],

$$\left( \frac{\partial \mu_1}{\partial \ln X_1} \right)_{T,P} = \left( \frac{\partial \mu_2}{\partial \ln X_2} \right)_{T,P}$$

With Equation (15.5), we were led to Equation (15.21),

$$\left( \frac{\partial \mu_2}{\partial \ln X_2} \right)_{T,P} = RT$$

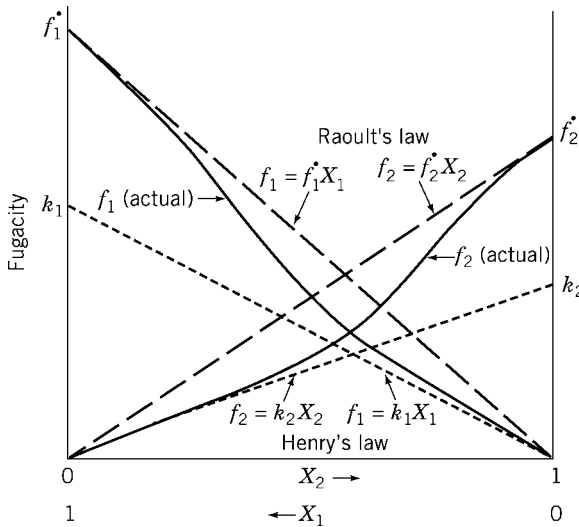


Figure 15.2. Limiting-law nature of Henry's law and Raoult's law.



Integration of Equation (15.21) leads to

$$\int \left( \frac{\partial \mu_2}{\partial \ln X_2} \right)_{T,P} d \ln X_2 = \int R T d \ln X_2 \quad (15.26)$$

or to

$$\mu_2 = RT \ln X_2 + C' \quad (15.27)$$

We cannot evaluate the constant of integration in Equation (15.27) as easily as we did with Equation (15.24), because in the limit of  $X_2 = 0$ , where Henry's law is followed,  $\ln X_2$  would approach negative infinity. (As  $X_2 \rightarrow 0$ ,  $\mu_2$  also tends toward negative infinity.) Instead, let us make use of the equation for the chemical potential of component 2 in the gas phase in equilibrium with the solution. That is [from Equation (10.23)],

$$\mu_{2,g} = \mu_{2,g}^\circ + RT \ln \frac{f_2}{f_2^\circ} = \mu_2 = RT \ln X_2 + C' \quad (15.28)$$

Therefore,

$$\ln f_2 - \ln X_2 = \frac{C'}{RT} - \frac{\mu_{2,g}^\circ}{RT} + \ln f_{2,g}^\circ = C'' \quad (15.29)$$

from which it follows that

$$\frac{f_2}{X_2} = e^{C''} = K \quad (15.30)$$

This is Henry's law [Equation (15.1)].

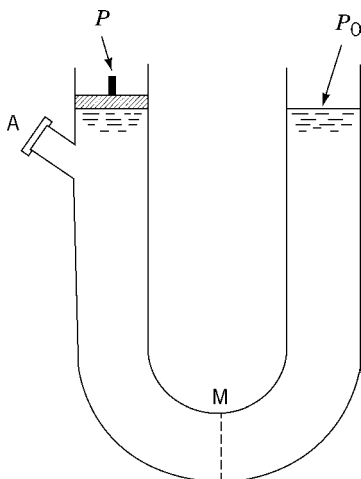
## 15.4 VAN'T HOFF'S LAW OF OSMOTIC PRESSURE<sup>2</sup>

As we indicated in Chapter 13, the requirement that all phases be at the same pressure at equilibrium does not apply in all situations, and in particular, it does not apply to two phases of different composition separated by a rigid membrane. If the membrane is permeable to only one component, we can show that the pressure on the two phases must be different if equilibrium is maintained at a *fixed temperature*.

Consider the apparatus illustrated schematically in Figure 15.3, in which two portions of pure solvent are separated by a membrane  $M$  that is permeable only to the solvent. Both compartments are filled to the level of the piston on the left. The liquid levels are equal, the pressures  $P$  and  $P_0$  are equal at equilibrium, and

$$\mu_1^\bullet(\text{left}) = \mu_1^\bullet(\text{right}) \quad (15.31)$$

<sup>2</sup>The use of the Gibbs–Duhem equation to derive the limiting laws for colligative properties is based on the work of W. Bloch.



**Figure 15.3.** Schematic diagram of apparatus for measurement of osmotic pressure.

If we add through the side arm *A* some solute to which the membrane is impermeable, then with adequate mixing, the solute will become distributed uniformly throughout the left chamber but will be absent from the right chamber. Solvent then will be observed to move from the right to the left side because

$$\mu_1(\text{left}) < \mu_1^\bullet(\text{right}) \quad (15.32)$$

The chemical potential and the escaping tendency of the pure solvent are always greater than the chemical potential and the escaping tendency of the solvent in the solution.

The movement of solvent can be prevented and equilibrium can be restored if the pressure *P* is made sufficiently greater than *P*<sub>0</sub>. In the new equilibrium state

$$\mu_1(\text{left}) = \mu_1^\bullet(\text{right}) \quad (15.33)$$

and

$$d\mu_1(\text{left}) = d\mu_1^\bullet(\text{right}) = 0 \quad (15.34)$$

because  $\mu_1^\bullet(\text{right})$  was not affected by either the addition of solute to the left chamber or the increase of pressure on the left chamber.

As  $\mu_1$  is a function of the pressure *P* and the mole fraction of solute *X*<sub>2</sub>, we can express  $d\mu_1(\text{left})$  in Equation (15.34) as

$$d\mu_1 = \left( \frac{\partial \mu_1}{\partial P} \right)_{T, X_2} dP + \left( \frac{\partial \mu_1}{\partial \ln X_2} \right)_T d \ln X_2 = 0 \quad (15.35)$$

From the Gibbs–Duhem equation at constant temperature and pressure [Equation (11.34)], we can write

$$\left(\frac{\partial\mu_1}{\partial\mu_2}\right)_{T,P} = -\frac{n_2}{n_1} = -\frac{X_2}{X_1} \quad (15.36)$$

By the chain rule of differential calculus

$$\left(\frac{\partial\mu_1}{\partial\ln X_2}\right)_{T,P} = \left(\frac{\partial\mu_1}{\partial\mu_2}\right)_{T,P} \left(\frac{\partial\mu_2}{\partial\ln X_2}\right)_{T,P} = -\frac{X_2}{X_1} \left(\frac{\partial\mu_2}{\partial\ln X_2}\right)_{T,P} \quad (15.37)$$

Substituting from Equation (15.37) in Equation (15.35), and substituting  $V_{m1}$  for  $(\partial\mu_1/\partial P)_{T,X_2}$ , from Equation (9.25), we have

$$V_{m1}dP - \frac{X_2}{X_1} \left(\frac{\partial\mu_2}{\partial\ln X_2}\right)_{T,P} \frac{dX_2}{X_2} = 0 \quad (15.38)$$

With the insertion of Equation (15.21)

$$\left(\frac{\partial\mu_2}{\partial\ln X_2}\right)_{T,P} = RT$$

into Equation (15.38), we find that

$$V_{m1}dP - \frac{RT}{X_1}dX_2 = 0 \quad (15.39)$$

or

$$\left(\frac{\partial P}{\partial X_2}\right)_T = \frac{RT}{X_1 V_{m1}} \quad (15.40)$$

As Henry's law is valid only in the limit of a very dilute solutions, we can write a limiting law for Equation (15.40) as

$$\begin{aligned} \lim_{x_2 \rightarrow 0} \left(\frac{\partial P}{\partial X_2}\right)_T &= \lim_{x_2 \rightarrow 0} \frac{RT}{X_1 V_{m1}} \\ &= \frac{RT}{V_{m1}^\bullet} \end{aligned} \quad (15.41)$$

or, in the limit of a dilute solution,

$$dP = \frac{RT}{V_{m1}^\bullet} dX_2 \quad (15.42)$$

If we assume that  $V_{m1}^\bullet$  is independent of  $P$  over the range for which Equation (15.42) is valid, we can integrate Equation (15.42) as follows:

$$\int_{P_0}^P dP = \frac{RT}{V_{m1}^\bullet} \int_{X_2=0}^{X_2} dX_2 \quad (15.43)$$

or

$$P - P_0 = \frac{RT}{V_{m1}^\bullet} X_2 \quad (15.44)$$

The difference in pressures,  $P - P_0$ , required to maintain osmotic equilibrium is defined as the *osmotic pressure* and is denoted by  $\Pi$ . Equation (15.44) thus becomes

$$\Pi = \frac{RT}{V_{m1}^\bullet} X_2 \quad (15.45)$$

As the solution is dilute, so that  $X_2 \cong n_2/n_1$ ,

$$\begin{aligned} \Pi &= \frac{RT}{V_{m1}^\bullet} \frac{n_2}{n_1} \\ &= \frac{n_2 RT}{V_1} \end{aligned} \quad (15.46)$$

in which  $V_1$  is the total volume of solvent. Because the solution is dilute,  $V_1 \cong V$ , the total volume of the solution, and

$$\begin{aligned} \Pi &= \frac{n_2}{V} RT \\ &= c_2 RT = \frac{w_2 RT}{M_2} \end{aligned} \quad (15.47)$$

in which  $c_2$  is the concentration of solute in moles per unit volume, usually  $1 \text{ dm}^3$ ;  $w_2$  is the mass concentration (mass per unit volume); and  $M_2$  is the molar mass. Equation (15.47), called van't Hoff's law of osmotic pressure, is clearly a limiting law. A more accurate expression is

$$\lim_{c_2 \rightarrow 0} \frac{\Pi}{c_2} = RT \quad (15.48)$$

or

$$\lim_{w_2 \rightarrow 0} \frac{\Pi}{w_2} = \frac{RT}{M_2} \quad (15.49)$$

Values for  $\Pi$  can be determined experimentally at different mass concentrations. The ratio  $\Pi/w_2$ , plotted against  $w_2$  and extrapolated to  $w_2 = 0$ , gives a value of  $RT/M_2$ . The unknown molar mass then is calculated.

In this form, van't Hoff's law of osmotic pressure is also used to determine the molar masses of biological and synthetic macromolecules. When the osmotic pressure is measured for a solution of macromolecules that contains more than one species of macromolecule (for example, a synthetic polymer with a distribution of molar masses or a protein molecule that undergoes association or dissociation), the osmotic pressures of the various solute species  $\Pi_i$  are additive. That is, in sufficiently dilute solution

$$\begin{aligned}\Pi &= \sum_i \Pi_i \\ &= RT \sum_i \frac{w_i}{M_i}\end{aligned}\quad (15.50)$$

If we divide each side of Equation (15.50) by  $w = \sum w_i$ , we obtain

$$\begin{aligned}\frac{\Pi}{w} &= \frac{RT \sum_i \frac{w_i}{M_i}}{\sum_i w_i} \\ &= \frac{RT}{\left(\sum_i w_i\right) / \sum_i \frac{w_i}{M_i}}\end{aligned}\quad (15.51)$$

The number-average molar mass  $M_n$  is defined as

$$M_n = \frac{\sum_i c_i M_i}{\sum_i c_i}\quad (15.52)$$

where  $c_i$  is the molar concentration of each species  $i$ . Consequently,

$$\begin{aligned}M_n &= \frac{\sum_i (w_i/M_i)M_i}{\sum_i (w_i/M_i)} \\ &= \frac{\sum_i w_i}{\sum_i (w_i/M_i)}\end{aligned}\quad (15.53)$$

Therefore, we can rewrite Equation (15.51) in the form of a limiting law as

$$\lim_{w \rightarrow 0} \frac{\Pi}{w} = \frac{RT}{M_n}\quad (15.54)$$

Thus, the result of an osmotic pressure experiment with a mixture of solute macromolecules yields the number-average molar mass  $M_n$ .

### Osmotic Work in Biological Systems

As we mentioned at the end of Chapter 7, an important application of the Gibbs function to biological systems is the calculation of the minimum work required to maintain a nonequilibrium concentration gradient across a membrane. In living cells, these gradients are not maintained by pressure differences, as in the osmotic pressure experiment described here but by active transport processes whose mechanisms are just beginning to be understood [1]. The function of a thermodynamic analysis is to verify that the work-producing part of the mechanism is adequate to maintain the observed gradient.

If we assume that solutes in biological systems are at low enough concentrations to obey Henry's law, their chemical potentials are given individually as [Equation (15.11)]

$$\mu_2 = \mu_2^\circ + RT \ln \left( \frac{m_2}{m_2^\circ} \right)$$

Thus, the change in the Gibbs function for the transfer of one mole of the solute from a molality  $m_2$  to a molality  $m'_2$  is

$$\begin{aligned} \Delta G_m &= \mu'_2 - \mu_2 \\ &= RT \ln \frac{m'_2}{m_2} \end{aligned} \quad (15.55)$$

If  $m'_2$  is greater than  $m_2$ , then  $\Delta G_m$  is positive and work must be performed on the system by the surroundings to carry out the transfer. According to Equation (7.80)

$$\Delta G_m < W_{\text{net,irrev}}$$

in which  $W_{\text{net}}$  is positive when work is performed on the system. Thus,

$$W_{\text{net,irrev}} > RT \ln \frac{m'_2}{m_2} \quad (15.56)$$

and because  $W_{\text{net}}$  and  $\Delta G_m$  are positive

$$|W_{\text{net,irrev}}| > RT \ln \frac{m'_2}{m_2} \quad (15.57)$$

For example, if the molality of glucose in blood is  $5.5 \times 10^{-3} \text{ mol kg}^{-1}$  and in urine is  $5.5 \times 10^{-5} \text{ mol kg}^{-1}$ , then to transport glucose back into the blood, the kidney must perform work against this gradient equal to at least

$$\begin{aligned} RT \ln \frac{5.5 \times 10^{-3} \text{ mol kg}^{-1}}{5.5 \times 10^{-5} \text{ mol kg}^{-1}} &= (8.314 \text{ J K}^{-1} \text{ mol}^{-1})(310 \text{ K}) \ln 100 \\ &= 11.870 \text{ J (mol glucose)}^{-1} \end{aligned} \quad (15.58)$$

Any mechanism suggested for carrying out the active transport of glucose in the kidney must provide at least this much work.

### 15.5 VAN'T HOFF'S LAW OF FREEZING-POINT DEPRESSION AND BOILING-POINT ELEVATION

Let us consider a pure solid phase, such as ice, in equilibrium with a pure liquid phase, such as water, at some specified temperature and pressure. If the two phases are in equilibrium

$$\mu_{1,s}^{\bullet} = \mu_1^{\bullet} \quad (15.59)$$

in which  $\mu_{1,s}^{\bullet}$  represents the chemical potential of the pure solid and  $\mu_1^{\bullet}$  represents the chemical potential of the pure liquid. If solute is added to the system, and if it dissolves only in the liquid phase, then the chemical potential of the liquid solvent will be decreased:

$$\mu_1 < \mu_1^{\bullet}$$

To reestablish equilibrium,  $\mu_{1,s}^{\bullet}$  must be decreased also. This decrease in  $\mu$  can be accomplished by decreasing the temperature. The chemical potential of the liquid solvent is decreased by the drop in temperature as well as by the addition of solute. Equilibrium is reestablished if

$$d\mu_{1,s}^{\bullet} = d\mu_1 \quad (15.60)$$

As the chemical potential of the solid phase depends only on the temperature, whereas that of the solvent in the solution depends on both temperature and concentration of added solute, the total differentials of Equation (15.60) can be expressed in terms of the appropriate partial derivatives, as follows:

$$\left(\frac{\partial \mu_{1,s}^{\bullet}}{\partial T}\right)_P dT = \left(\frac{\partial \mu_1}{\partial T}\right)_{P,X_2} dT + \left(\frac{\partial \mu_1}{\partial \ln X_2}\right)_{P,T} d \ln X_2 \quad (15.61)$$

From Equation (9.24),

$$\left(\frac{\partial \mu_{1,s}^{\bullet}}{\partial T}\right)_P = -S_{m,s}^{\bullet}; \left(\frac{\partial \mu_1}{\partial T}\right)_{P,X_2} = -S_{m1} \quad (15.62)$$

and from Equation (15.21) and Equation (15.37)

$$\left(\frac{\partial \mu_1}{\partial \ln X_2}\right)_{P,T} d \ln X_2 = -\frac{RT}{X_1} dX_2 \quad (15.63)$$

If we substitute from Equations (15.62) and (15.63) into Equation (15.61), we obtain

$$-S_{m,s}^{\bullet} dT = -\xi_{m1} dT - \frac{RT}{X_1} dX_2$$

or

$$\left(\frac{\partial T}{\partial X_2}\right)_P = -\frac{RT}{X_1(S_{m1} - S_{m,s}^{\bullet})} \quad (15.64)$$

If we express Equation (15.64) as a limiting law, which is consistent with the observation that Henry's law is valid only in very dilute solutions,

$$\begin{aligned} \lim_{x_2 \rightarrow 0} \left(\frac{\partial T}{\partial X_2}\right)_P &= -\frac{RT}{S_{m1}^{\bullet} - S_{m,s}^{\bullet}} \\ &= -\frac{RT}{\Delta_f S_{m1}} \end{aligned} \quad (15.65)$$

At equilibrium at constant temperature and pressure [Equations (8.9) and (8.10)]

$$\Delta S_m = \frac{\Delta H_m}{T}$$

so that

$$\lim_{x_2 \rightarrow 0} \left(\frac{\partial T}{\partial X_2}\right)_P = -\frac{RT^2}{\Delta_f H_{m1}} \quad (15.66)$$

in which  $\Delta_f H_{m1}$  is the molar enthalpy of fusion of pure solid component 1 to pure, supercooled, liquid component 1. This result is analogous to that in Equation (14.65), to which Equation (15.66) is a limiting-law equivalent. Whether we choose to use the



equations to describe the temperature dependence of the solubility of a component or the concentration dependence of the freezing point is a matter of point of view.

If  $\Delta_f H_{m1}$  is assumed to be constant in the small temperature range from the freezing point of the pure solvent  $T_0$  to the freezing point of solution  $T$ , Equation (15.66) is integrated as

$$\frac{\Delta_f H_{m1}}{R} \int_{T_0}^T \frac{dT}{T^2} = - \int_0^{X_2} dX_2 \quad (15.67)$$

or

$$\frac{\Delta_f H_{m1}}{R} \left[ \frac{1}{T_0} - \frac{1}{T} \right] = -X_2 \quad (15.68)$$

If  $T_0 \cong T$ , another approximation is

$$\Delta T = - \frac{RT_0^2}{\Delta_f H_{m1}} X_2 \quad (15.69)$$

The preceding expression, like the other laws of the dilute solution, is a limiting law. It is expressed more accurately as

$$\lim_{x_2 \rightarrow 0} \frac{\Delta T}{X_2} = - \frac{RT_0^2}{\Delta_f H_{m1}} \quad (15.70)$$

By a similar set of arguments, it can be demonstrated that the boiling point elevation for dilute solutions containing a nonvolatile solute is given by the expression

$$\lim_{x_2 \rightarrow 0} \frac{\Delta T}{X_2} = \frac{RT_0^2}{\Delta_v H_{m1}} \quad (15.71)$$

in which  $\Delta_v H_{m1}$  is the molar enthalpy of vaporization of pure liquid component 1.

According to Equation (15.6), in a solution sufficiently dilute that the limiting form of Equation (15.70) applies,

$$\begin{aligned} X_2 &= \frac{n_2}{n_1} \\ &= n_2 \frac{M_1}{w_1} \end{aligned}$$

where  $w_1$  is the mass of solvent, which is usually expressed in kilograms. But  $n_2/w_1$  is equal to  $m_2$ , so that in dilute solution,

$$X_2 = m_2 M_1 \quad (15.72)$$

If we substitute for  $X_2$  from Equation (15.72) in Equation (15.70), which is written for dilute solutions, then

$$\begin{aligned}\Delta T &= \left( \frac{RT^2 M_1}{\Delta_f H_{m1}} \right) m_2 \\ &= K_f m_2\end{aligned}\quad (15.73)$$

where  $K_f$  is the molal freezing point depression constant of the solvent, which is equal to  $RT^2 M_1 / \Delta_f H_{m1}$ .

As the laws of dilute solution are limiting laws, they may not provide an adequate approximation at finite concentrations. For a more satisfactory treatment of solutions of finite concentrations, for which deviations from the limiting laws become appreciable, the use of new functions, the activity function and excess thermodynamic functions, is described in the following chapters.

## EXERCISES

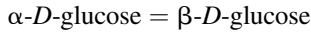
- 15.1.** Derive Equation (15.71), the van't Hoff expression for the elevation of the boiling point.
- 15.2.** If a molecule of solute dissociates into two particles in dilute solution, Henry's law can be expressed by the relationship

$$f_2 = K(X_2)^2 \quad (15.74)$$

in which  $X_2$  is the mole fraction of solute calculated as if no dissociation took place.

- a.** Derive the Nernst law for the distribution of this solute between two solvents; in one solvent, the solute dissociates, and in the other, it does not.
- b.** Derive the other laws of the dilute solution for such a dissociating solute.
- 15.3.** Derive the laws of the dilute solution for a solute, one molecule of which dissociates into  $\nu$  particles.
- 15.4. a.** The standard Gibbs function for the formation at 298 K of  $\alpha$ -D-glucose(s) is  $-902,900 \text{ J mol}^{-1}$ . The solubility of this sugar in 80% ethanol at this temperature is  $20 \text{ g kg}^{-1}$  solvent, and the solute obeys Henry's law up to saturation in this solvent. Compute  $\Delta_f G_m^\circ$  for this sugar at 298 K in 80% ethanol. The standard state for this dissolved solute is a hypothetical 1-molal solution.
- b.** The standard Gibbs function for the formation at 298 K of  $\beta$ -D-glucose(s) is  $-901,200 \text{ J Mol}^{-1}$ . The solubility of this sugar in 80% ethanol at this temperature is  $49 \text{ g kg}^{-1}$  solvent, and this solute also obeys Henry's law up to

saturation. Calculate the equilibrium constant for the reaction (in 80% ethanol)



- 15.5.** A solution of  $\alpha\text{-D-Glucose}$  in water obeys Henry's law up to high concentrations and throughout a wide range of temperature and pressure. (*Note:* This does not mean that the Henry's law constant  $k$  is independent of pressure or temperature; it is not.)
- Calculate the heat absorbed when a solution containing 0.01 mole of glucose and 1000 g of solvent is mixed with one containing 0.05 mole of glucose and 1000 g of solvent.
  - Calculate the volume change in the mixing described in (a).
- 15.6.** Compute  $\Delta_f G_m^\circ$  of  $\text{O}_2(\text{aq})$  at  $25^\circ\text{C}$ , that is,  $\Delta G_m^\circ$  of formation of oxygen dissolved in water at a hypothetical molality of  $1 \text{ mol kg}^{-1}$ . The solubility of oxygen in water exposed to air is  $0.00023 \text{ mol kg}^{-1}$ . The saturated solution may be assumed to follow Henry's law.
- 15.7.** According to Wagman *et al.* [2],  $\Delta_f G_m^\circ$  of  $\text{Cl}_2(\text{aq})$  that is,  $\Delta G_m^\circ$  of formation of chlorine dissolved in water at a hypothetical molality of  $1 \text{ mol kg}^{-1}$ , is  $6.94 \text{ kJ mol}^{-1}$  at  $298.15 \text{ K}$ . The enthalpy of solution of gaseous chlorine at 1 atm ( $101.3 \text{ kPa}$ ) into a saturated aqueous solution is  $-25 \text{ kJ mol}^{-1}$ .
- Neglecting hydrolysis reactions of  $\text{Cl}_2$  in  $\text{H}_2\text{O}$ , and assuming that dissolved chlorine follows Henry's law, calculate the solubility of chlorine (in moles per kilogram of water) when the pressure of the pure gas is  $101.3 \text{ kPa}$ . Assume also that the pure gas behaves ideally.
  - If dissolved chlorine follows Henry's law, calculate  $\Delta_f H_m^\circ$  of  $\text{Cl}_2(\text{aq})$ .

**TABLE 15.1. Osmotic Pressure Data for Polyvinyl Acetate in Methyl Ethyl Ketone at  $10^\circ\text{C}$**

$w/(\text{kg m}^{-3})$	$\Pi/w/(\text{J kg}^{-1})$
0.052	1451
0.076	1792
0.129	2515
0.148	2821
0.194	3546
0.315	5911
0.321	6045
0.479	9493
0.572	11410
0.590	12142
0.645	13310

- 15.8.** The solubility of nitrogen in water exposed to air at  $0^{\circ}\text{C}$  is  $0.84 \times 10^{-3} \text{ mol kg}^{-1}$ . Dissolved  $\text{N}_2$  follows Henry's law. Calculate  $\Delta_f G_{\text{m},273.15 \text{ K}}^{\circ}$  of  $\text{N}_2(\text{aq})$ .
- 15.9.** Table 15.1 contains osmotic pressure data calculated from the work of Browning and Ferry [3] for solutions of polyvinyl acetate in methyl ethyl ketone at  $10^{\circ}\text{C}$ . Plot  $\Pi/w$  against  $w$ , fit the data to a quadratic polynomial, and calculate the number-average molar mass from the intercept with the  $\Pi/w$  axis.

## REFERENCES

1. *Ion Channels*, B. Rudy and L. E. Iverson, eds., in *Methods in Enzymology*, Vol. 207, Academic Press New York, 1992; T. Chikashi, N. Hiroma, and T. Takeo, *Nature* **432**, 361–368 (2004).
2. D. D. Wagman, et al., NBS Tables of Thermodynamic Data, *J. Phys. Chem. Ref. Data* **11**, Supplement No. 2 (1982).
3. G. V. Browning and J. D. Ferry, *J. Chem. Phys.* **17**, 1107 (1949).



## CHAPTER 16

---

# ACTIVITIES, EXCESS GIBBS FUNCTIONS, AND STANDARD STATES FOR NONELECTROLYTES

---

In the preceding chapters we considered Raoult's law and Henry's law, which are laws that describe the thermodynamic behavior of dilute solutions of nonelectrolytes; these laws are strictly valid only in the limit of infinite dilution. They led to a simple linear dependence of the chemical potential on the logarithm of the mole fraction of solvent and solute, as in Equations (14.6) (Raoult's law) and (15.5) (Henry's law) or on the logarithm of the molality of the solute, as in Equation (15.11) (Henry's law). These equations are of the same form as the equation derived for the dependence of the chemical potential of an ideal gas on the pressure [Equation (10.15)].

When we try to describe the behavior of solutions over the entire range of composition, we find that no universal relationship exists between chemical potential and a composition variable. When faced with a similar situation with real gases, G. N. Lewis invented the *fugacity* function so that he could obtain a linear dependence of the chemical potential of a gas on the logarithm of the fugacity. The characteristics of specific gases were then expressed implicitly by the dependence of the fugacity on the pressure. Similarly, Lewis invented the (dimensionless) *activity* function so that he could obtain a linear dependence of the chemical potential on the logarithm of the activity. The characteristics of specific solvent–solute combinations were then expressed by the dependence of the activity on the mole fraction or the molality. The use of activity is especially advantageous when the focus is on individual components of a solution, as in the treatment of reactants and products in a chemical reaction (Section 16.3) or the treatment of cell potentials in solutions of electrolytes (Section 19.2).

An alternative approach that is particularly applicable to binary solutions of nonelectrolytes is that of excess thermodynamic functions for the solution instead of activities for the components. That approach is most useful in treatments of phase equilibria and separation processes [1], and it will be discussed in Section 16.7.

## 16.1 DEFINITIONS OF ACTIVITIES AND ACTIVITY COEFFICIENTS

### Activity

The *activity*  $a_i$ , of a component of a solution is defined by the equation

$$\mu_i = \mu_i^\circ + RT \ln a_i \quad (16.1)$$

together with one of the following limiting conditions:  
for solvent,

$$\lim_{x_1 \rightarrow 1} \frac{a_1}{X_1} = 1 \quad (16.2)$$

for solute on the mole fraction scale,

$$\lim_{x_2 \rightarrow 0} \frac{a_2}{X_2} = 1 \quad (16.3)$$

and for solute on the molality scale,

$$\lim_{m_2 \rightarrow 0} \frac{a_2}{m_2/m_2^\circ} = 1 \quad (16.4)$$

In Equation (16.4),  $m_2^\circ$  is the molality that corresponds to  $\mu_2^\circ$ , that is, the molality of the standard state. The latter three constraints are imposed because we want Equation (16.1) to approach Equation (14.6), Equation (15.5), or Equation (15.11) in the appropriate limit.

### Activity Coefficient

The deviation of a solvent from the limiting-law behavior of Raoult's law is described conveniently by a function called the *activity coefficient*, which is defined (on a mole fraction scale) as

$$\gamma_1 = \frac{a_1}{X_1} \quad (16.5)$$

Equation (16.1) can then be written as

$$\mu_1 = \mu_1^\circ + RT \ln X_1 + RT \ln \gamma_1 \quad (16.6)$$

The deviation of a solute from the limiting behavior of Henry's law, on the mole fraction scale, is also described conveniently by the activity coefficient, which in this

case is defined as

$$\gamma_2 = \frac{a_2}{X_2} \quad (16.7)$$

Equation (16.1) can then be written as

$$\mu_2 = \mu_2^\circ + RT \ln X_2 + RT \ln \gamma_2 \quad (16.8)$$

If the molality is a more convenient composition measure than the mole fraction, the activity coefficient of the solute is defined as

$$\gamma_2 = \frac{a_2}{m_2/m_2^\circ} \quad (16.9)$$

and Equation (16.1) can be written as

$$\mu_2 = \mu_2^\circ + RT \ln \left( \frac{m_2}{m_2^\circ} \right) + RT \ln \gamma_2 \quad (16.10)$$

Although we cannot determine its absolute value, the chemical potential of a component of a solution has a value that is independent of the choice of concentration scale and standard state. The standard chemical potential, the activity, and the activity coefficient have values that do depend on the choice of concentration scale and standard state. To complete the definitions we have given, we must define the standard states we wish to use.

Whether  $\mu_i$ ,  $\gamma_i$ , and  $a_i$  refer to a mole fraction composition scale or to a molality composition scale will be clear from the context in which they are used. We will not attempt to use different symbols for each scale.

## 16.2 CHOICE OF STANDARD STATES

From the nature of the definition [Equation (16.1)], it is clear that the activity of a given component may have any numeric value, depending on the state chosen for reference, but  $a_i^\circ$  must be equal to 1. No reason exists other than convenience for one state to be chosen as the standard in preference to any other. It frequently will be convenient to change standard states as we proceed from one type of problem to another. Nevertheless, certain choices generally have been adopted. Unless a clear statement is made to the contrary, we will assume the following conventional standard states in all of our discussions.

### Gases

If Equation (16.1) is to be consistent with Equation (10.14), it is clear that, for a real gas

$$a_i = \frac{f_i}{f^\circ} \quad (16.11)$$

and that the standard state of a gas is that state at which  $f = 1$  bar (0.1 MPa), along a line extrapolated from values of  $f$  at a low pressure, as indicated in Figure 10.5. For an



ideal gas, because  $f = P$ ,

$$a_i = \frac{P_i}{P^\circ} \quad (16.12)$$

and  $P^\circ = 1 \text{ bar (0.1 MPa)}$ .

## Liquids and Solids

**Pure Substances.** In most problems involving pure substances, it is convenient to choose the pure solid or the pure liquid at each temperature and at a pressure of 1 bar (0.1 MPa) as the standard state. According to this convention, the activity of a pure solid or pure liquid at 1 bar is equal to 1 at any temperature.

**Solvent in Solution.** We shall use the pure substance at the same temperature as the solution and at its equilibrium vapor pressure as the reference state for the component of a solution designated as the solvent. This choice of standard state is consistent with the limiting law for the activity of solvent given in Equation (16.2), where the limiting process leads to the solvent at its equilibrium vapor pressure. To relate the standard chemical potential of solvent in solution to the state that we defined for the pure liquid solvent, we need to use the relationship

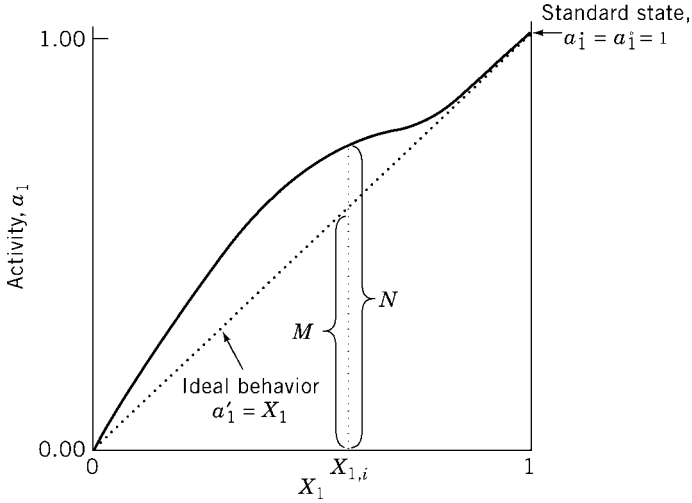
$$\mu_i^\circ(\text{solvent}) = \mu_i^\circ(\text{pure liquid}) + \int_{P_i^\circ}^{P_i^*} V_m^\bullet dP \quad (16.13)$$

where  $P_i^\circ$  is equal to 1 bar and  $P_i^*$  is the vapor pressure of the pure liquid at the temperature of the solution.<sup>1</sup> Thus, the activity of the “pure solvent” is equal to 1 at the vapor pressure of the solvent, whereas the activity of the “pure liquid” is equal to 1 at 1 bar because they have different standard states. The chemical potential of the solvent in solution at any finite concentration cannot be greater than the chemical potential of the pure liquid solvent. If it were, a portion of pure solvent would separate spontaneously from the solution, with a concomitant decrease in the Gibbs function of the system.

The solid curve in Figure 16.1 shows the activity of the solvent in a solution as a function of the mole fraction of solvent. If the solution were ideal, Equations (14.6) and (16.1) would both be applicable over the whole range of mole fractions. Then,  $a_1 = X_1$ , which is a relationship indicated by the broken line in Figure 16.1. Also, because Equation (16.1) approaches Equation (14.6) in the limit as  $X_1 \rightarrow 1$  for the real solution, the solid curve approaches the ideal line asymptotically as  $X_1 \rightarrow 1$ .

The broken line in Figure 16.1 has a slope of 1. In this figure, when  $X_1$ , the abscissa, is equal to 1,  $a_1$ , the ordinate, is equal to 1. The activity coefficient  $a_1/X_1$  at any concentration of solvent  $X_{1(i)}$  is given by the ratio  $N/M$  because  $N$  is

<sup>1</sup> As  $P_i^\circ$  is equal to 1 bar and the vapor pressure of the pure solvent is usually less than 1 bar, the magnitude of the correction is small. For example, for water the correction is less than  $1.8 \text{ J mol}^{-1}$ .



**Figure 16.1.** Activity and activity coefficients for solvent when a Raoult's-law standard state is chosen.

$a_1$ , and because the slope of the broken line is 1,  $M$  is equal to  $X_1$ . In the example illustrated by Figure 16.1, the activity coefficient of the solvent is always greater than or equal to 1. If the solid line lay below the (broken) line for ideal behavior, the activity coefficient always would be less than or equal to 1. Generally, in a real solution

$$\gamma_1 = \frac{a_1}{X_1} \neq 1 \quad (16.14)$$

As we observe that the solvent approaches Raoult's-law behavior in the limit of infinite dilution, we also can state that

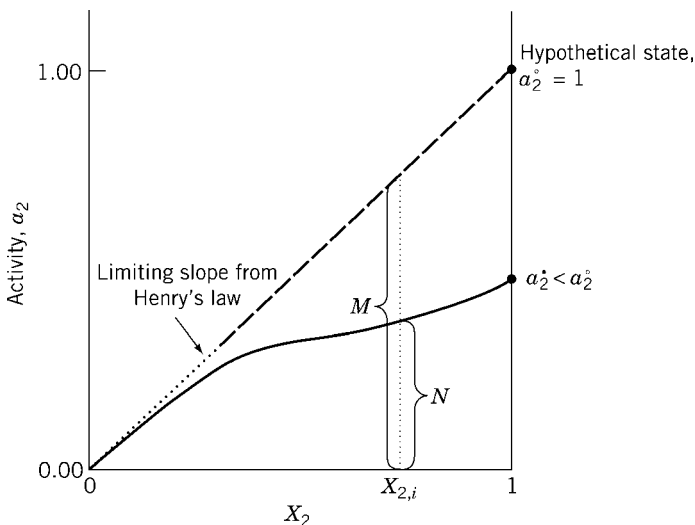
$$\lim_{x_1 \rightarrow 1} \frac{a_1}{X_1} = \lim_{x_1 \rightarrow 1} \gamma_1 = 1 \quad (16.15)$$

The activity coefficient of the solvent is 1 at all concentrations in an ideal solution because

$$\gamma_1 = \frac{a_1}{X_1} = \frac{X_1}{X_1} = 1 \quad (16.16)$$

Thus, the ideal solution is a reference for the solvent in a real solution, and the activity coefficient of the solvent measures the deviation from ideality.

**Solute in Solution.** When the mole fraction scale is used, it is convenient to choose a standard state such that the activity would approach the mole fraction in



**Figure 16.2.** Activity and activity coefficient for solute when a standard is chosen by extrapolation of Henry's law on a mole fraction basis.

the limit of infinite dilution in which Henry's law is valid. That is,

$$\lim_{X_2 \rightarrow 0} \frac{a_2}{X_2} = 1 \quad (16.17)$$

because Equation (16.1) approaches Equation (15.5) in the limit as  $X_2 \rightarrow 0$ . The solid curve in Figure 16.2 represents the activity of the solute as a function of the mole fraction  $X_2$  of the solute, when the standard state is chosen to be the hypothetical state of unit mole fraction extrapolated along the Henry's-law line. In the example in Figure 16.2, *no real state* of the solution exists in which the activity of the solute is equal to 1.

This choice of a standard state for the solute may appear strange at first glance. It might seem that the choice of pure solute as standard state would be a simpler one. The latter procedure would require either experimental information on the pure solute in the same physical state (for example, liquid or solid) as the solution or data for solutions of sufficiently high concentration of solute so that Raoult's law might be approached and might be used for the extrapolation to obtain  $a_2$  at  $X_2 = 1$ . Such information for most solutes is not available. The details of the solid curve in Figure 16.2 may be known only for small values of  $X_2$  and not throughout the entire concentration range. Thus, usually no means for determining the value exist that  $a_2$  would approach for pure, supercooled, liquid solute. However, with data available only at low concentrations of solute, it is sometimes<sup>2</sup> feasible to find the limiting slope and the constant in Henry's law and, hence, to determine  $p_2^\circ$  equal to  $k_2$  for the *hypothetical* state selected as the standard state.

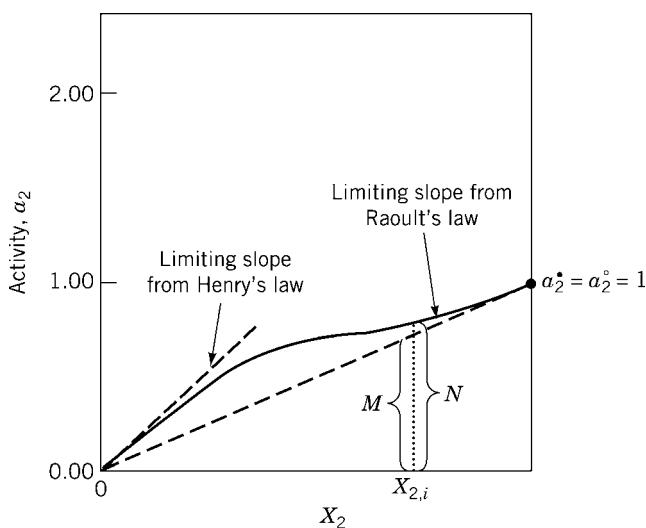
<sup>2</sup>We shall see in Chapter 17 that it is frequently difficult to obtain reliable data at very low concentrations to demonstrate experimentally that Henry's law is followed in dilute solutions of nonelectrolytes.

When data are available for the solute over the entire concentration range, from mole fraction 0 to 1, the choice of standard state, either the hypothetical unit mole fraction (Henry's law) or the actual unit mole fraction (Raoult's law), is arbitrary, but it is frequently easier to demonstrate Raoult's law as a limiting law than Henry's law. Figure 16.2 shows the relationships for activity and activity coefficient when Henry's law is used to define the standard state, and Figure 16.3 shows the same relationships when pure solute is chosen as the standard state.

It can be seen from Figures 16.2 and 16.3 that the numerical values of the activity and activity coefficient of the solute are different for the two choices of standard state. The scale of activities, for example, is necessarily different. The activity coefficient at mole fraction  $X_{2(i)}$  is given by the ratio  $N/M$  in both figures. Thus, when the standard state is chosen on the basis of Henry's law, the activity coefficients are less than 1, whereas when the pure solute is chosen as standard state, the activity coefficients all are greater than 1.

However, the choice of standard states makes no difference in the value of  $\Delta G_m$  for the transfer of solute between two solutions of different concentrations in the same solvent. We can observe this by applying the definition of activity to the equation for the free energy change in a transfer process:

$$\begin{aligned}\Delta G_m &= \mu'_2 - \mu_2 \\ &= \mu_2^\circ + RT \ln a'_2 - [\mu_2^\circ + RT \ln a_2] \\ &= RT \ln a'_2 - RT \ln a_2 \\ &= RT \ln \frac{a'_2}{a_2}\end{aligned}\tag{16.18}$$



**Figure 16.3.** Activity and activity coefficient for solute when a Raoult's-law standard state is chosen.

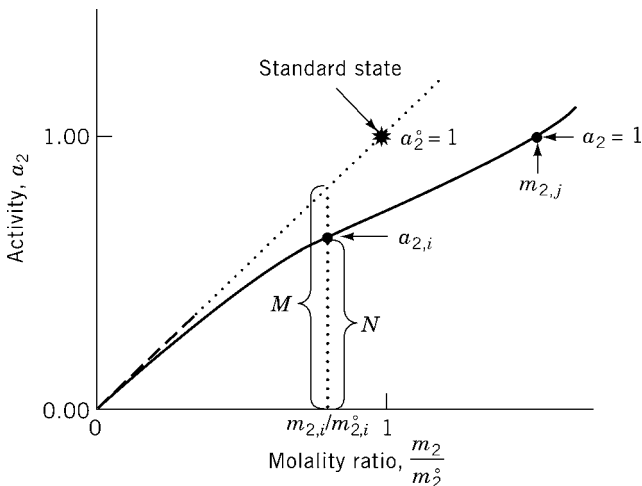
The values  $\mu_2'$  and  $\mu_2$  are characteristic of the states of the system and do not depend on the choice of a standard state. It can be observed that the curves in Figure 16.2 and Figure 16.3 differ only by a scale factor that is determined by the choice of the point at which  $a_2 = a_2^\circ = 1$ . If both  $a_2'$  and  $a_2$  are based on the same standard state, their ratio is independent of that choice.

The molality is used as a concentration scale primarily for solutions for which data are not available for concentrations approaching pure solute, so the Henry's-law basis for choosing the standard state is the only practical choice. The behavior of an example of such a solution is shown in Figure 16.4.

For such solutions, the definition of activity is completed by the requirement that the activity approach the molality ratio in the limit of infinite dilution. That is,

$$\lim_{m_2 \rightarrow 0} \frac{a_2}{m_2/m_2^\circ} = \lim_{m_2 \rightarrow 0} \gamma_2 = 1 \quad (16.19)$$

The standard state chosen on this basis is indicated by the asterisk in Figure 16.4. This reference state is a *hypothetical 1-molal solution*, that is, a state that has the activity that a 1-molal solution would have *if it obeyed the limiting law*. It is misleading to say that the standard state of the solute is the infinitely dilute solution because  $a_2$  equals zero in an infinitely dilute solution. It is clear from the graph that the activity of the solute may be greater than 1 at high  $m_2$ . The activity coefficient at  $m_{2,i}$  [i.e.,  $\gamma_{2,i} = a_{2,i}/(m_{2,i}/m_2^\circ)$ ] is represented by the ratio  $N/M$  (because the height  $M$  is numerically equal to the distance  $m_{2(i)}/m_2^\circ$  along the abscissa) and represents the deviation of the behavior of the solute from Henry's law. The activity coefficient  $\gamma_{2(i)}$  also is equal to the slope of a line from the origin to the point  $a_{2(i)}$ .



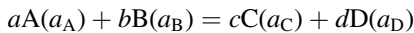
**Figure 16.4.** Activity and activity coefficient for solute when a standard state is chosen by extrapolation of Henry's law on a molality basis.

We can observe from Figure 16.4 that for the particular system depicted, a solution of some finite concentration  $m_{2(j)}$  exists for which the activity is 1. Nevertheless, it would be misleading to call this solution of molality  $m_{2(i)}$  the standard state. The standard state has the properties that a 1-molal solution would have *if it obeyed the limiting law*; the solution of molality  $m_{2(i)}$  generally does not obey the limiting law.

### 16.3 GIBBS FUNCTION AND THE EQUILIBRIUM CONSTANT IN TERMS OF ACTIVITY

With the definition of the activity function, we could derive a general expression that relates  $\Delta G_m^\circ$  of a reaction to the equilibrium constant and hence to eliminate the restrictions imposed on previous relationships.

Let us consider the chemical reaction



From Equation (9.15)

$$dG = \mu_A dn_A + \mu_B dn_B + \mu_C dn_C + \mu_D dn_D \quad (16.20)$$

Applying the procedure used in Equations (9.49) through (9.51) and integrating from  $\xi = 0$  to  $\xi = 1$ , we obtain

$$\Delta G_m = c\mu_C + d\mu_D - a\mu_A - b\mu_B \quad (16.21)$$

Substitution for the chemical potentials from Equation (16.1) gives

$$\begin{aligned} \Delta G_m &= c(\mu_C^\circ + RT \ln a_C) + d(\mu_D^\circ + RT \ln a_D) \\ &\quad - a(\mu_A^\circ + RT \ln a_A) - b(\mu_B^\circ + RT \ln a_B) \end{aligned}$$

This equation may be written as

$$\Delta G_m = (c\mu_C^\circ + d\mu_D^\circ - a\mu_A^\circ - b\mu_B^\circ) + RT \ln \frac{a_C^c a_D^d}{a_A^a a_B^b} \quad (16.22)$$

The expression in parentheses in Equation (16.22) is equal to  $\Delta G_m^\circ$ , so we can write

$$\Delta G_m = \Delta G_m^\circ + RT \ln \frac{a_C^c a_D^d}{a_A^a a_B^b} \quad (16.23)$$

Equation (16.23) is a general relationship for the calculation of  $\Delta G_m$  for any reaction from the value for  $\Delta G_m^\circ$  and from the activities  $a_A$ ,  $a_B$ ,  $a_C$ , and  $a_D$ . We emphasize that Equation (16.23) refers to a system in which a mole of reaction occurs with no change in the activity of any reactant or product. Either the system is very large, the *infinite copy model* (as described in Section 9.6) or one in which we calculate the molar

change in Gibbs function from the change corresponding to an infinitesimal amount of reaction, with  $(dG/d\xi)_{T,P}$  as a criterion of equilibrium [see Equation (9.52)].

At equilibrium at constant temperature and pressure,  $\Delta G_m = 0$  and

$$\frac{\Delta G_m^\circ}{RT} = -\ln \left[ \frac{a_C^c a_D^d}{a_A^a a_B^b} \right]_{\text{equil}} \quad (16.24)$$

From the definitions of standard states for components of solutions, it is clear that  $\Delta G_m^\circ$  is a function only of the temperature, because the standard state of each reactant and product is defined at a specific fixed pressure. Thus,  $\Delta G_m^\circ$  is a constant for a particular reaction at a fixed temperature. Hence, we can write

$$\frac{\Delta G_m^\circ}{RT} = -\ln K_a \quad (16.25)$$

in which  $K_a$  is the equilibrium constant in terms of activities. Consequently

$$K_a = \left[ \frac{a_C^c a_D^d}{a_A^a a_B^b} \right]_{\text{equil}} \quad (16.26)$$

If the mole fraction is a convenient variable, Equation (16.3) can be used to write Equation (16.26) as

$$K_a = \frac{X_C^c \gamma_C^c X_D^d \gamma_D^d}{X_A^a \gamma_A^a X_B^b \gamma_B^b} \quad (16.27)$$

$$= \frac{X_C^c X_D^d \gamma_C^c \gamma_D^d}{X_A^a X_B^b \gamma_A^a \gamma_B^b} \quad (16.28)$$

$$= K_x K_\gamma \quad (16.29)$$

Similarly, for reactants and products for which molality is the convenient composition variable, we can write

$$K_a = K_m K_\gamma \quad (16.30)$$

where

$$K_m = \frac{(m_C/m^\circ)^c (m_D/m^\circ)^d}{(m_A/m^\circ)^a (m_B/m^\circ)^b} \quad (16.31)$$

An equilibrium constant for some reactions can be expressed in terms of mole fractions for some components and molalities for other components.

If the value of  $K_a$  for a reaction is calculated from the value of  $\Delta G_m^\circ$ , we must have values of the  $\gamma_i$  to substitute into Equation (16.27) or Equation (16.30) to obtain equilibrium yields in terms of  $m_i$  or  $X_i$ . The determination of these quantities from experimental data will be discussed in Chapters 17 and 19.

## 16.4 DEPENDENCE OF ACTIVITY ON PRESSURE

As  $\mu_i = \mu_i^\circ + RT \ln a_i$

$$\left(\frac{\partial \mu_i}{\partial P}\right)_{T,X} = \left(\frac{\partial \mu_i^\circ}{\partial P}\right)_{T,X} + RT \left(\frac{\partial \ln a_i}{\partial P}\right)_{T,X} \quad (16.32)$$

From Equation (9.25)

$$\left(\frac{\partial \mu_i}{\partial P}\right)_{T,X} = V_{mi}$$

Although we have chosen to define the standard state at a fixed pressure, the vapor pressure of the pure solvent, the standard chemical potential is still a function of the pressure chosen, so that the first term on the right in Equation (16.32) is equal to  $V_{mi}^\circ$ . Therefore,

$$\left(\frac{\partial \ln a_i}{\partial P}\right)_{T,X} = \frac{V_{mi} - V_{mi}^\circ}{RT} \quad (16.33)$$

For solvents,  $V_{mi}^\circ$  is equal to  $V_{mi}^*$ , because the standard state is the pure solvent, if we neglect the small effect of the difference between the vapor pressure of pure solvent and 1 bar. As the standard state for the solute is the *hypothetical* unit mole fraction state (Fig. 16.2) or the *hypothetical* 1-molal solution (Fig. 16.4), the chemical potential of the solute that follows Henry's law is given either by Equation (15.5) or Equation (15.11). In either case, because mole fraction and molality are not pressure dependent,

$$\left(\frac{\partial \mu_2}{\partial P}\right)_{T,m_2,X_2} = \left(\frac{\partial \mu_2^\circ}{\partial P}\right)_{T,m_2,X_2}$$

so that

$$V_{m,2} = V_{m,2}^\circ$$

Thus, the partial molar volume is constant along the Henry's-law line and equal to the standard partial molar volume. The only real solution along the Henry's-law line is the infinitely dilute solution, so

$$V_{m,2}^\circ = V_{m,2}^\infty \quad (16.34)$$



## 16.5 DEPENDENCE OF ACTIVITY ON TEMPERATURE

From previous discussions of temperature coefficients of the Gibbs function (see Section 7.2), we expect the expression for the temperature dependence of the activity to involve an enthalpy function. Hence, we need to develop relationships for the enthalpies of the standard states.

### Standard Partial Molar Enthalpies

For pure solids and liquids, the standard enthalpy is the enthalpy of the substance at the specified temperature and at 1 bar.

**Solvent.** We have defined the pure solvent at the same temperature as the solution and at its equilibrium vapor pressure as the standard state for the solvent. It follows that

$$H_{m1(\text{standard state})} = H_{m1}^{\circ} = H_{m1}^{\bullet} \quad (16.35)$$

with the second equality valid if we neglect the trivial effect on the enthalpy of the small change of pressure from 1 bar to the vapor pressure of the solvent.

**Solute.** The standard state for the solute is the *hypothetical* unit mole fraction state (Fig. 16.2) or the *hypothetical* 1-molal solution (Fig. 16.4). In both cases, the standard state is obtained by extrapolation from the Henry's-law line that describes behavior at infinite dilution. Thus, the partial molar enthalpy of the standard state is *not* that of the *actual* pure solute or the *actual* 1-molal solution.

The chemical potential on a molality scale of the solute that follows Henry's law is given by Equation (16.10) with  $\gamma_2 = 1$ .

$$\mu_2 = \mu_2^{\circ} + RT \ln \left( \frac{m_2}{m_2^{\circ}} \right)$$

If we divide each term in Equation (16.10) by  $T$  and differentiate with respect to  $T$  at constant  $P$  and  $m_2$ , the result is

$$\left[ \frac{\partial(\mu_2/T)}{\partial T} \right]_{P,m_2} = \left[ \frac{\partial(\mu_2^{\circ}/T)}{\partial T} \right]_{P,m_2} \quad (16.36)$$

From Equation (9.57)

$$\left[ \frac{\partial(\mu/T)}{\partial T} \right]_{P,m_2} = -\frac{H_m}{T^2}$$

Substituting from Equation (9.57) into Equation (16.36), we have

$$-\frac{H_{m2}}{T^2} = -\frac{H_{m2}^{\circ}}{T^2}$$

or

$$H_{m2} = H_{m2}^{\circ} \quad (16.37)$$

Thus, the partial molar enthalpy along the Henry's-law line is constant and equal to the standard partial molar enthalpy. The only real solution along the Henry's-law line is the infinitely dilute solution, so that

$$H_{m2}^{\circ} = H_{m2}^{\infty} \quad (16.38)$$

For this reason, the infinitely dilute solution frequently is called the reference state for the partial molar enthalpy of both solvent and solute.

### Equation for Temperature Derivative of the Activity

From Equation (16.1)

$$\mu_i = \mu_i^{\circ} + RT \ln a_i$$

or

$$\frac{\mu_i}{T} = \frac{\mu_i^{\circ}}{T} + R \ln a_i \quad (16.39)$$

From Equation (9.57)

$$\left[ \frac{\partial(\mu/T)}{\partial T} \right]_{P,m_2} = -\frac{H_m}{T^2}$$

If we differentiate Equation (16.39) with respect to temperature at constant molality and pressure, and substitute from Equation (9.57), the result is

$$-\frac{H_{mi}}{T^2} = -\frac{H_{mi}^{\circ}}{T^2} + R \left( \frac{\partial \ln a_i}{\partial T} \right)_{P,m_2}$$

or

$$\left( \frac{\partial \ln a_i}{\partial T} \right)_{P,m_2} = -\frac{H_{mi} - H_{mi}^{\circ}}{RT^2} \quad (16.40)$$

From Equations (16.35), (16.37), and (16.38), we observe that for solute and solvent,  $H_{mi}^{\circ}$  is equal to  $H_{mi}^{\infty}$ . Therefore, we can write Equation (16.40) for either solvent or solute as

$$\left( \frac{\partial \ln a_i}{\partial T} \right)_{P,m_2} = -\frac{H_{mi} - H_{mi}^{\infty}}{RT^2} \quad (16.41)$$

in which  $H_{mi}^{\infty} - H_{mi}$  is the change in partial molar enthalpy on dilution to an infinitely dilute solution.

From the definition of the activity coefficient [Equations (16.5) and (16.9)],

$$\gamma_i = \frac{a_i}{m_i/m_i^\circ} \quad \text{or} \quad \gamma_i = \frac{a_i}{X_i}$$

we can show that for the solute

$$\left( \frac{\partial \ln \gamma_2}{\partial T} \right)_{P, m_2} = - \frac{H_{m2} - H_{m2}^\infty}{RT^2} \quad (16.42)$$

and for the solvent

$$\left( \frac{\partial \ln \gamma_1}{\partial T} \right)_{P, X_1} = - \frac{H_{m1} - H_{m1}^\infty}{RT^2} \quad (16.43)$$

## 16.6 STANDARD ENTROPY

We have pointed out that a concentration  $m_{2(i)}$  of the solute in the real solution may have an activity of 1, which is equal to the activity of the hypothetical 1-molal standard state. Also,  $H_{m2}^\circ$ , the partial molar enthalpy of the solute in the standard state, equals the partial molar enthalpy of the solute at infinite dilution. We might inquire whether the *partial molar entropy* of the solute in the standard state  $S_{m2}^\circ$  corresponds to the partial molar entropy in either of these two solutions.

Let us compare  $S_{m2}$  for a real solution with  $S_{m2}^\circ$  of the hypothetical 1-molal solution. For any component of a solution, from Equation (9.20), we can write

$$\mu_2 = H_{m2} - TS_{m2}$$

Hence,

$$-TS_{m2} = \mu_2 - H_{m2} \quad \text{and} \quad -TS_{m2}^\circ = \mu_{m2}^\circ - H_{m2}^\circ$$

and

$$-T(S_{m2} - S_{m2}^\circ) = (H_{m2}^\circ - H_{m2}) + (\mu_2 - \mu_2^\circ) \quad (16.44)$$

At infinite dilution, that is, when  $m_2 = 0$

$$S_{m2} \neq S_{m2}^\circ \quad (\text{at } m_2 = 0) \quad (16.45)$$

because

$$\mu_2 \neq \mu_2^\circ \quad (\text{at } m_2 = 0) \quad (16.46)$$

even though

$$H_{m2} = H_{m2}^\circ \quad (\text{at } m_2 = 0)$$

Hence, the partial molar entropy of the solute in the standard state is not that of the solute at infinite dilution. Similarly, at the molality  $m_{2(j)}$  (Fig. 16.4), where  $a_2$  is unity

$$S_{m2} \neq S_{m2}^\circ \quad (\text{at molality where } a_2 = 1) \quad (16.47)$$

because

$$H_{m2} \neq H_{m2}^\circ \quad (\text{at molality where } a_2 = 1) \quad (16.48)$$

even though

$$\mu_2 = \mu_2^\circ \quad (\text{at molality where } a_2 = 1) \quad (16.49)$$

Thus,  $S_{m2}$  can be equal to  $S_{m2}^\circ$  only for a solution with some molality  $m_{2(k)}$  at which

$$(H_{m2}^\circ - H_{m2}) = (G_{m2}^\circ - G_{m2}) = \mu_2^\circ - \mu_2 \quad (16.50)$$

The particular value of the molality  $m_{2(k)}$  at which  $S_{m2(k)} = S_{m2}^\circ$  differs from solute to solute and for different solvents with the same solute.

We can summarize our conclusions about the thermodynamic properties of the solute in the hypothetical 1-molal standard state as follows. Such a solute is characterized by values of the thermodynamic functions that are represented by  $\mu_2^\circ$ ,  $H_{m2}^\circ$ , and  $S_{m2}^\circ$ . Frequently a real solution at some molality  $m_{2(j)}$  also exists (Fig. 16.4) for which  $\mu_2 = \mu_2^\circ$ , that is, for which the activity has a value of 1. The real solution for which  $H_{m2}$  is equal to  $H_{m2}^\circ$  is the one at infinite dilution. Furthermore,  $S_{m2}$  has a value equal to  $S_{m2}^\circ$  for some real solution only at a molality  $m_{2(k)}$  that is neither zero nor  $m_{2(j)}$ . Thus, three different real concentrations of the solute exist for which the thermodynamic qualities  $\mu_2$ ,  $H_{m2}$ , and  $S_{m2}$  respectively, have the same values as in the hypothetical standard state.

For the solvent, the standard thermodynamic properties are

$$\mu_1^\circ = \mu_1^\bullet = \mu_1^\infty \quad (16.51)$$

and

$$H_{m1}^\circ = H_{m1}^\bullet = H_{m1}^\infty \quad (16.52)$$

so

$$S_{m1}^\circ = S_{m1}^\bullet = S_{m1}^\infty \quad (16.53)$$

so long as we neglect the effects of the pressure difference between the pure liquid at 1 bar and the pure solvent at its vapor pressure.

Table 16.1 summarizes the information on the standard states of pure phases as well as those of solvents and solutes.

A more elegant (although more difficult to visualize) formulation of the procedure for the selection of the standard state for a solute may be made as follows. From Equation (16.1)

$$\mu_2 = \mu_2^\circ + RT \ln a_2$$

**TABLE 16.1. Standard States for Thermodynamic Calculations (For every case, it is assumed that the temperature has been specified)**

Physical State	Chemical Potential	Enthalpy <sup>a</sup>	Entropy	Volume
Pure gas	Hypothetical ideal gas at 1 bar (0.1 MPa). Also, a pressure, usually near 1 bar, will exist at which the real gas has a fugacity of unity.	Hypothetical ideal gas at 1 bar; also real gas at zero pressure. (See Exercise 1, this chapter.)	Hypothetical ideal gas at 1 bar (0.1 MPa). Also, a pressure of the real gas will exist, not zero and not that of unit fugacity, with an entropy equal to that in the standard state.	Hypothetical ideal gas at 1 bar (0.1 MPa). $V_m = (RT/P^{\circ})$ .
Pure liquid or pure solid	1 bar (0.1 MPa).	1 bar (0.1 MPa).	1 bar (0.1 MPa).	1 bar (0.1 MPa).
Solute in a solution <sup>b</sup>	Pure solvent at vapor pressure of pure solvent.	Pure solvent at vapor pressure of pure solvent.	Pure solvent at vapor pressure of pure solvent.	Pure solvent at vapor pressure of pure solvent.
Solute in a solution <sup>b,c</sup>	Hypothetical 1-molal solution obeying limiting law corresponding to Henry's law at vapor pressure of solvent. Also, a finite concentration may exist, not equal to zero, at which the activity of the solute is unity. This may be considered as the standard state <i>only in free energy calculations</i> .	Hypothetical 1-molal solution obeying limiting law corresponding to Henry's law at vapor pressure of pure solvent. The value of the partial molar enthalpy in the standard state $H_{m,2}^{\circ}$ is always equal to that at infinite dilution. Hence, the <i>infinitely dilute solution</i> can be considered the <i>standard state only in enthalpy calculations</i> .	Hypothetical 1-molal solution obeying limiting law corresponding to Henry's law at vapor pressure of pure solvent. Also, a solution of finite concentration may exist, not equal to zero but also not having an activity of unity, with a partial molar entropy of solute equal to that in the standard state.	Hypothetical 1-molal solution obeying limiting law corresponding to Henry's law at vapor pressure of pure solvent. The value of $V_{m,2}^{\circ}$ is equal to $V_{m,2}^{\infty}$ .

<sup>a</sup>For every case, it is assumed that the temperature has been specified.

<sup>b</sup>The standard state for the heat capacity is the same as that for the enthalpy. For a proof of this statement for the solute in a solution, see Exercise 2 in this chapter.

<sup>c</sup>This choice of standard state for components of a solution is different from that used by many thermodynamicists. It seems preferable to the choice of a 1-bar standard state, however, because it is more consistent with the extrapolation procedure by which the standard state is determined experimentally, and it leads to a value of the activity coefficient equal to 1 when the solution is ideal or very dilute whatever the pressure. It is also preferable to a choice of the pressure of the solution, because that choice produces a different standard state for each solution. For an alternative point of view, see Ref. 2.

and from Equation (16.9)

$$a_2 = \frac{m_2 \gamma_2}{m_2^\circ}$$

It follows that

$$\mu_2^\circ = \mu_2 - RT \ln \frac{m_2}{m_2^\circ} - RT \ln \gamma_2$$

Therefore the state in which the solute has a partial molar Gibbs function of  $\mu_2^\circ$  can be found from the following limit, because  $\gamma_2$  approaches unity as  $m_2$  approaches zero:

$$\lim_{m_2 \rightarrow 0} \left( \mu_2 - RT \ln \frac{m_2}{m_2^\circ} \right) = \mu_2^\circ$$

With this method of formulation, it also is possible to show that frequently a real solution at some molality  $m_j$  exists for which  $\mu_2 = \mu_2^\circ$ , that  $H_{m_2}^\circ$  corresponds to  $H_{m_2}$  for a real solution at infinite dilution, and that  $S_{m_2}^\circ$  equals  $S_{m_2}$  for a real solution at a molality  $m_{2k}$ , which is neither zero nor  $m_{2j}$ .

## 16.7 DEVIATIONS FROM IDEALITY IN TERMS OF EXCESS THERMODYNAMIC FUNCTIONS

Various functions have been used to express the deviation of observed behavior of solutions from that expected for ideal systems. Some functions, such as the activity coefficient, are most convenient for measuring deviations from ideality for a particular component of a solution. However, the most convenient measure for the solution as a whole, especially for mixtures of nonelectrolytes, is the series of *excess* functions (1) (3), which are defined in the following way.

We have derived an expression for the free energy of mixing two pure substances to form one mole of an ideal solution [Equation (14.35)],

$$\Delta G_{\text{mix,m}}^{\text{I}} = X_1 RT \ln X_1 + X_2 RT \ln X_2 \quad (16.54)$$

In actual systems, the observed value for the free energy of mixing  $\Delta G_{\text{mix,m}}$  may differ from  $\Delta G_{\text{mix,m}}^{\text{I}}$ . We define this difference, the excess free energy  $G_{\text{m}}^{\text{E}}$  as

$$\Delta G_{\text{m}}^{\text{E}} = \Delta G_{\text{mix,m}} - \Delta G_{\text{mix,m}}^{\text{I}} = \Delta G_{\text{mix,m}} - X_1 RT \ln X_1 - X_2 RT \ln X_2 \quad (16.55)$$

With a derivation analogous to that of Equation (14.35), we find that

$$\Delta G_{\text{mix,m}} = X_1 RT \ln a_1 + X_2 RT \ln a_2 \quad (16.56)$$

where the activities are based on Raoult's-law standard states.

Thus,

$$\begin{aligned} G_m^E &= X_1 RT \ln \frac{a_1}{X_1} + X_2 RT \ln \frac{a_2}{X_2} \\ &= X_1 RT \ln \gamma_1 + X_2 RT \ln \gamma_2 \end{aligned} \quad (16.57)$$

For the excess enthalpy  $H_m^E$ , because  $\Delta H_{\text{mix}}^I$  is zero

$$\begin{aligned} H_m^E &= \Delta H_{\text{mix},m} - \Delta H_{\text{mix},m}^I \\ &= \Delta H_{\text{mix},m} = X_1(H_{m1} - H_{m1}^\bullet) + X_2(H_{m2} - H_{m2}^\bullet) \end{aligned} \quad (16.58)$$

For the excess volume  $V_m^E$ , because  $\Delta V_{\text{mix}}^I$  is zero,

$$V_m^E = \Delta V_{\text{mix},m} = X_1(V_{m1} - V_{m1}^\bullet) + X_2(V_{m2} - V_{m2}^\bullet) \quad (16.59)$$

Similarly, we define the excess entropy  $S_m^E$  as

$$S_m^E = \Delta S_{\text{mix},m} - \Delta S_{\text{mix},m}^I = \Delta S_{\text{mix},m} + X_1 R \ln X_1 + X_2 R \ln X_2 \quad (16.60)$$

It can be shown that the usual relationships between temperature coefficients of the Gibbs function and entropy or enthalpy, respectively, also apply if stated for excess functions. Thus,

$$S_m^E = - \left( \frac{\partial G_m^E}{\partial T} \right)_{P,X} \quad (16.61)$$

and

$$H_m^E = G_m^E - T \left( \frac{\partial G_m^E}{\partial T} \right)_{P,X} \quad (16.62)$$

Excess thermodynamic functions can be evaluated most readily when the vapor pressures of both solute and solvent in a solution can be measured.

### Representation of $G_m^E$ as a Function of Composition

Redlich and Kister [4] suggested a convenient way to represent  $G_m^E$  as a function of composition that permits convenient classification of various kinds of deviation from ideality. From Equation (16.57)

$$\frac{G_m^E}{RT} = X_1 \ln \gamma_1 + (1 - X_1) \ln \gamma_2 \quad (16.63)$$

If we differentiate Equation (16.63) with respect to  $X_1$ , and simplify using the Gibbs–Duhem relationship [Equation (9.34)], the result is

$$\frac{d}{dX_1} \left( \frac{G_m^E}{RT} \right) = \ln \frac{\gamma_1}{\gamma_2} \quad (16.64)$$

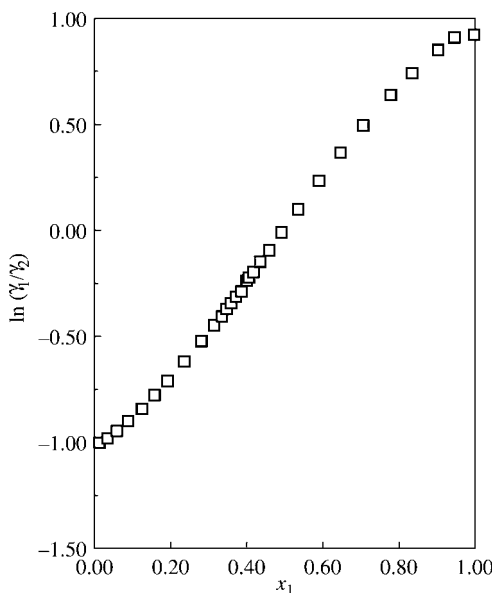
As  $G_m^E$  must equal 0 when  $X_1 = 0$  (pure solute) and when  $X_1 = 1$  (pure solvent),

$$\int_0^1 \ln \frac{\gamma_1}{\gamma_2} dX_1 = \int_0^1 \frac{d}{dX_1} \left( \frac{G_m^E}{RT} \right) dX_1 = \left( \frac{G_m^E}{RT} \right)_{X_1=1} - \left( \frac{G_m^E}{RT} \right)_{X_1=0} = 0 \quad (16.65)$$

Thermodynamic consistency of data on solutions can be tested by plotting  $\ln(\gamma_1/\gamma_2)$  against  $X_1$  and seeing whether the area between  $X_1 = 0$  and 0.5 is equal and opposite in sign to the area between 0.5 and 1.0. Such a plot is indicated in Figure 16.5 for solutions of methyl *t*-butyl ether and chloroform at 313.5 K (5).

Redlich and Kister suggested that solutions of different degrees of nonideality should be represented by a power series of the form

$$\begin{aligned} \frac{G_m^E}{RT} &= X_1 X_2 [B + C(X_1 - X_2) + D(X_1 - X_2)^2 + \dots] \\ &= X_1 X_2 [B + C(2X_1 - 1) + D(2X_1 - 1)^2 + \dots] \end{aligned} \quad (16.66)$$



**Figure 16.5.** A plot of  $\ln(\gamma_1/\gamma_2)$  for solutions of methyl *t*-butylether (1) and chloroform (2) at 313.5 K (5).



where the factor  $X_1X_2$  is present so that the quantity will be equal to 0 at  $X_1 = 0$  and at  $X_2 = 0$ , and  $B$ ,  $C$ , and  $D$  are coefficients that depend on the temperature and pressure but not on the composition. Such a series was used by Scatchard [6], after a suggestion of Guggenheim [7]. The factor  $(X_1 - X_2)$  is the variable of the power series because it is antisymmetrical with respect to interchange of components.

If the solution is ideal, that is, it follows Raoult's law,  $G_m^E = 0$ , and all coefficients are equal to 0. If all coefficients other than  $B$  are equal to 0,

$$\frac{G_m^E}{RT} = BX_1X_2 \quad (16.67)$$

where  $B$  is related to the interaction energy between components 1 and 2. These solutions have been called *regular solutions* by Guggenheim [8], and usually they describe those solutions in which both components have approximately the same molecular size ( $B$  is the  $\omega$  of Guggenheim) and  $\Delta S_{m,\text{mix}}$  is equal to the ideal value. If only  $B$  and  $C$  are  $\neq 0$ , the resulting equation is frequently called the Margules equation [9].

$$\frac{G_m^E}{RT} = X_1X_2[B + C(2X_1 - 1)] \quad (16.68)$$

The equation for the slope corresponding to Equation (16.64) is

$$\ln \frac{\gamma_1}{\gamma_2} = B(1 - 2X_1) + C[6X_1(1 - X_1) - 1] + \dots \quad (16.69)$$

We can distinguish easily among the three types of solutions discussed for  $G_m^E$  with a plot of  $\ln (\gamma_1/\gamma_2)$  against  $X_1$ . For an ideal solution, the result is a value of 0 for all points. For a regular solution, the plot is a straight line with slope equal to  $-2B$ , which passes through 0 at  $X_1 = 0.5$ . For correlations that require 2 or more parameters, the coefficients can be obtained from a least-squares analysis of the data for  $G_m^E$  as a function of  $X_1$  (see Section (A.1)).

## 16.8 REGULAR SOLUTIONS AND HENRY'S LAW (10; 11, p. 33–35)

Margulies [9] originally expressed his equation in terms of partial pressures. Expressed in terms of activities his equations are, for a regular solution,

$$\mu_{1(\text{cond})} = \mu_{1(\text{cond})}^\circ + RT \ln X_1 + A_1X_2 + B_1X_2^2 + \dots \quad (16.70)$$

and

$$\mu_{2(\text{cond})} = \mu_{2(\text{cond})}^\circ + RT \ln X_2 + A_2X_1 + B_2X_1^2 + \dots \quad (16.71)$$

where the standard state for each component is the Raoult's-law standard state, the pure component at its equilibrium vapor pressure. If we substitute from Margulies's equations limited to quadratic terms into the Gibbs–Duhem equation,

[Equation (15.18)],

$$X_1 \frac{\partial \mu_1}{\partial X_1} + X_2 \frac{\partial \mu_2}{\partial X_1} = 0$$

and equate the coefficients of corresponding powers of  $X_1$  and  $X_2$ , we obtain

$$\mu_{1(\text{cond})} = \mu_{1(\text{cond})}^\circ + RT \ln X_1 + BX_2^2 \quad (16.72)$$

and

$$\mu_{2(\text{cond})} = \mu_{2(\text{cond})}^\circ + RT \ln X_2 + BX_1^2 \quad (16.73)$$

where  $B = B_1 = B_2$  and  $A_1 = A_2 = 0$ .

But, at equilibrium,

$$\mu_{1(\text{cond})} = \mu_{1,\text{g}} = \mu_{1,\text{g}}^\circ + RT \ln \frac{p_1}{p^\circ} \quad (16.74)$$

and

$$\mu_{2(\text{cond})} = \mu_{2,\text{g}} = \mu_{2,\text{g}}^\circ + RT \ln \frac{p_2}{p^\circ} \quad (16.75)$$

In the limit of zero mole fraction of solute or unit mole fraction of solvent, the condition in which Henry's law is accurate as a limiting law, Equation (16.73) becomes

$$\mu_{2(\text{cond})} = \mu_{2(\text{cond})}^\circ + RT \ln X_2 + B \quad (16.76)$$

If we equate the chemical potential of the solute in the condensed phase with the chemical potential of the solute in the gas phase at equilibrium, we obtain

$$\begin{aligned} \mu_{2(\text{cond})} &= \mu_{2(\text{cond})}^\circ + RT \ln X_2 + B \\ &= \mu_{2(\text{cond})}^\bullet + RT \ln X_2 + B \\ &= \mu_{2,\text{g}} = \mu_{2,\text{g}}^\circ + RT \ln \frac{p_2}{p^\circ} \end{aligned} \quad (16.77)$$

Similarly, for pure solute,

$$\mu_{2(\text{cond})}^\bullet = \mu_{2(\text{g})}^\circ + RT \ln \frac{p^\bullet}{p^\circ} \quad (16.78)$$

If we substitute for  $\mu_{2(\text{cond})}^\bullet$  from Equation (16.78) into Equation (16.77), we obtain

$$\mu_{2,\text{g}}^\circ + RT \ln \frac{p^\bullet}{p^\circ} + RT \ln X_2 + B = \mu_{2,\text{g}}^\circ + RT \ln \frac{p_2}{p^\circ} \quad (16.79)$$

Then,

$$p_2 = p_2^\bullet e^{\frac{B}{RT}} X_2 = K_H X_2 \quad (16.80)$$

where

$$K_H = p_2^\bullet e^{\frac{B}{RT}} \quad (16.81)$$

so that the definition of the regular solution leads to Henry's law, as a limiting law valid in the limit of infinite dilution. That we can derive Henry's law from the Margules equation with a standard state of pure solute is not inconsistent with our convenient choice of a unit mole fraction standard state extrapolated from the Henry's-law line.

### 16.9 REGULAR SOLUTIONS AND LIMITED MISCIBILITY (11, p. 41–45)

Ideal solutions are miscible over the whole range of composition. We can show, however, that regular solutions exhibit limited miscibility. From Equations (16.72) and (16.6), we obtain the relation for a regular solution

$$\ln \gamma_1 = \frac{B}{RT} X_2^2 = B' X_2^2 \quad (16.82)$$

So that,

$$a_1 = X_1 e^{B' X_2^2}$$

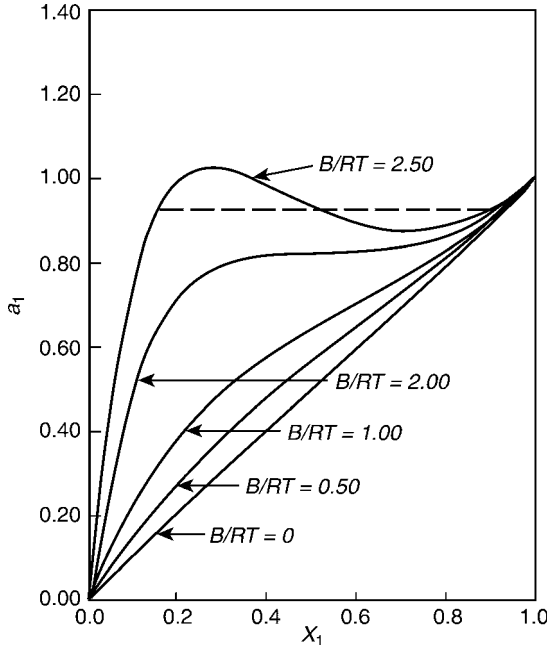
If we plot  $a_1$  against  $X_1$  for varying values of  $B/RT$ , we obtain the curves shown in Figure 16.6.

The curve at  $B/RT = 2.50$  shows a convex upward curvature, which indicates that  $X_1$  is a two-valued function of  $a_1$ . Thus, in that system, two phases with different compositions exist. Thus,  $B$  is a parameter that describes phase separation and limited miscibility.

The curve with  $B/RT = 2.00$  is the one with the highest value of  $B/RT$  in a one phase system. It is called the critical solution curve. We can determine the thermodynamic significance of  $B$  from the following analysis.

The Gibbs function of mixing is

$$\begin{aligned} \Delta G_{(m,\text{mix})} &= \frac{G_{(\text{mixture})}}{n_1 + n_2} - \frac{n_1 G_{m1}^\bullet + n_2 G_{m2}^\bullet}{n_1 + n_2} \\ &= X_1 \mu_1 + X_2 \mu_2 - X_1 \mu_1^\bullet - X_2 \mu_2^\bullet \\ &= X_1 RT \ln X_1 + X_2 RT \ln X_2 + B(X_1^2 + X_2^2) \end{aligned} \quad (16.83)$$



**Figure 16.6.** Variation of  $a_1$  with  $X_1$  for a regular solution with various values of  $B/RT$ .

The entropy of mixing is, from Equation (14.34)

$$\Delta S_{(m,mix)} = - \left[ \frac{\partial \Delta G_{(m,mix)}}{\partial T} \right]_X \tag{16.84}$$

If  $B$  is not a function of  $T$ ,

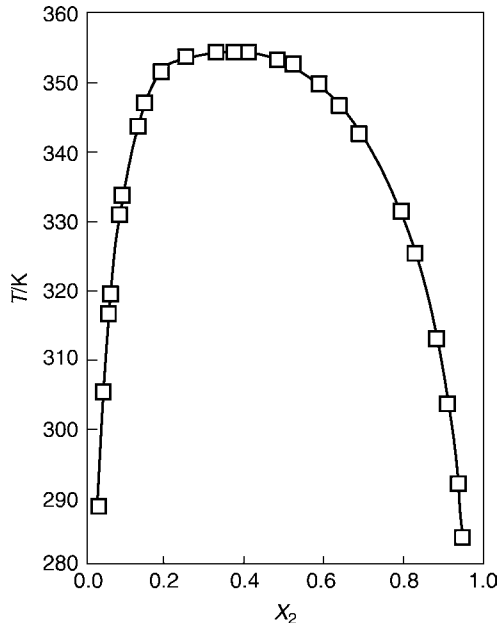
$$\Delta S_{m,mix} = -X_1 R \ln X_1 - X_2 R \ln X_2 \tag{16.85}$$

which is the ideal entropy of mixing.

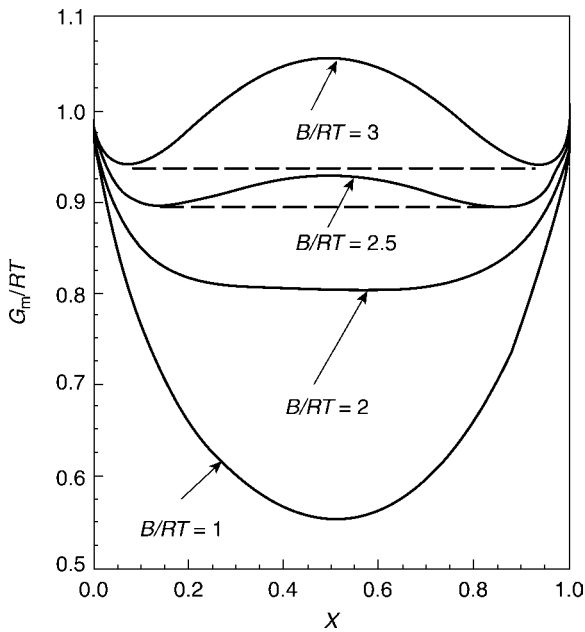
Then

$$\begin{aligned} \Delta H_{(mix)} &= \Delta G_{(mix)} + T \Delta S_{(mix)} \\ &= B(X_1^2 + X_2^2) \end{aligned} \tag{16.86}$$

and  $B$  is a measure of the enthalpy of mixing, which is temperature independent. Thus,  $B' = B/RT$  is inversely proportional to  $T$ , and the largest value of  $B'$  at which the two components are completely miscible represents the lowest temperature at which they are miscible. This temperature is called the *upper critical solution temperature*. Figure 16.7 shows the liquid–liquid equilibrium curve for ethanenitrile [1] and 2,2,4-trimethylpentane [2], with a critical upper solution temperature of



**Figure 16.7.** Liquid–liquid equilibrium curve for ethanenitrile (1) and 2,2,4-trimethylpentane (2), with a critical upper solution temperature of 354.55 K (12).



**Figure 16.8.** Graph of  $G_m/RT$  for solution with critical upper solution temperature.

354.55 K (12). The difference in composition between the two phases in equilibrium is called the *miscibility gap*.

We can see the basis of the miscibility gap in another way by plotting  $G_m$  for the mixture as a function of  $X_1$ , as shown in Figure 16.8. In plotting, we assume arbitrary equal values for  $\mu_1^\bullet$  and  $\mu_2^\bullet$ , where  $G_m$  is the sum of  $X_1\mu_1 + X_2\mu_2$ .

We can observe that for values of  $B/RT$  greater than 2, the curves have two concave upward sections, and points between the concave upward sections have a greater value of  $G_m$  than the minima, thus showing that two immiscible phases have lower values of  $G_m$  than a single phase, even though the single phase has a lower value of  $G_m$  than do the pure components. A more advanced treatment of the miscibility gap can be found in Guggenheim's treatise [13].

## EXERCISES

**16.1.** For a pure gas, the fugacity is defined so that [Equation (10.30)]

$$\lim_{P \rightarrow 0} \frac{f}{P} = 1$$

Show that, on this basis, the enthalpy of the gas in the standard state must be equal to that at zero pressure. (*Hint:* If the gas were ideal,  $f = P$  at all pressures. For the real gas,  $f^\circ = k = 0.1$  MPa. Proceed by analogy with the discussion in Section 10.2.)

**16.2. a.** Differentiate both sides of Equation (16.40) with respect to  $T$ .

**b.** Prove that  $C_{Pm(2)}^\circ$  is equal to  $C_{Pm(2)}$  for the infinitely dilute solution. Keep in mind that the temperature coefficient of  $\ln \gamma_2$  is zero in an infinitely dilute solution.

**16.3.** Frequently it is necessary to convert solute activity coefficients based on mole fraction to a molality basis, or vice versa. The equation for making this conversion can be derived in the following way.

**a.** Starting from the fundamental definitions of activity on each concentration basis, prove that for a solute

$$\frac{a_X}{a_m} = \frac{k_2''}{k_2}$$

in which the subscript  $X$  refers to a mole fraction basis and  $m$  to a molality basis, and  $k_2$  and  $k_2''$  are the Henry's-law constants on a mole fraction and molality basis, respectively.

b. Show also that

$$\frac{\gamma_X}{\gamma_m} = \frac{m_2/m_2^\circ k_2''}{X_2 k_2}$$

[ $k_2$  and  $k_2''$  are defined by Equations (15.1) and (15.7)]

c. In very dilute solutions, Henry's law is valid in the form of either Equation (15.1) or Equation (15.7). Prove that

$$k_2'' = k_2 M_1 m_2^\circ$$

in which  $M_1$  is the molar mass of the solvent, when the mass and the molar mass of the solvent are both expressed in kilograms.

d. Show that for any concentration

$$\frac{\gamma_X}{\gamma_m} = 1 + m_2 M_1$$

(A factor of 1000 appears in these equations if the molar mass of the solvent is expressed in grams; that is,  $k_2'' = k_2 M_1 m_2^\circ / 1000$ , and  $\gamma_X / \gamma_m = 1 + m_2 M_1 / 1000$ .)

16.4. Molality  $m_2$  and molarity  $c_2$  are related by the expression

$$m_2 = \frac{c_2}{\rho - c_2 M_2}$$

in which  $\rho$  is the density of the solution, with mass in kilograms and volume in cubic decimeters (Liters). If  $\gamma_c$ , the activity coefficient on a molarity basis, is defined by

$$\gamma_c = \frac{a_c}{\frac{c}{c^\circ}}$$

show that

$$\frac{\gamma_m}{\gamma_c} = \left[ \frac{\rho}{\rho_1} - \frac{c_2 M_2}{\rho_1} \right]$$

in which  $\rho_1$  is the density of pure solvent.

16.5. Statistical thermodynamic analysis of regular solutions, with solvent and solute molecules of the same size, indicate that the free energy of mixing per mole of solution is given by

$$\Delta G_{\text{mix}} = RT(X_1 \ln X_1 + X_2 \ln X_2) + X_1 X_2 \omega$$

in which  $\omega$  is a parameter related to the interaction energies between molecules. Show that

$$S_m^E = -X_1 X_2 \frac{\partial \omega}{\partial T}$$

and

$$H_m^E = X_1 X_2 \left( \omega - T \frac{\partial \omega}{\partial T} \right)$$

- 16.6.** Starting with Equation (16.55) for  $G_m^E$ , derive Equations (16.60) and (16.58) for the excess entropy and enthalpy of mixing, respectively.
- 16.7.** At 42°C the enthalpy of mixing of 1 mole of water and 1 mole of ethanol is  $-343.1$  J. The vapor pressure of water above the solution is  $0.821 p_1^\circ$  and that of ethanol is  $0.509 p_2^\circ$ , in which  $p^\circ$  is the vapor pressure of the corresponding pure liquid. Assume that the vapors behave as ideal gases. Compute the excess entropy of mixing.
- 16.8.** Rhombic sulfur is soluble in  $\text{CS}_2$  and so is monoclinic. For the transition

$$S(\text{rhombic}) = S(\text{monoclinic}) \quad \Delta G_{m,298}^\circ = 96 \text{ J mol}^{-1}$$

The solubility of monoclinic sulfur in  $\text{CS}_2$  is 22-molal. What is the solubility of rhombic sulfur in the same solvent? Assume that the activity coefficient for both forms of dissolved sulfur is 1.

- 16.9.** Use the equations for  $G_m^E$ ,  $S_m^E$ , and  $H_m^E$  to show that

$$\begin{aligned} \Delta S_{\text{mix}} = X_1 & \left( \frac{H_{m1} - H_{m1}^\circ}{T} - R \ln a_1 \right) \\ & + X_2 \left( \frac{H_{m2} - H_{m2}^\circ}{T} - R \ln a_2 \right) \end{aligned} \quad (16.84)$$

- 16.10.** Show that Equation (16.64) follows from Equation (16.63), using the Gibbs–Duhem equation.
- 16.11.** Derive Equation (16.69) from Equation (16.68).
- 16.12.** Derive Equations (16.72) and (16.73) from Equations (16.70) and (16.71).
- 16.13.** Create a graph analogous to Figure 16.8, with the corresponding negative values of  $B/RT$ . Comment on the differences between the two graphs, with special attention to the relation of  $B$  to  $\Delta H_{(m,\text{mix})}$  and the connection between  $\Delta H_{(m,\text{mix})}$  and the existence of a miscibility gap.



## REFERENCES

1. J. M. Prausnitz, R. N. Lichtenthaler, and E. G. de Azevedo, *Molecular Thermodynamics of Fluid-Phase Equilibria*, 3rd ed., Prentice-Hall, Upper Saddle River, NJ, 1999, Chap. 6.
2. K. Denbigh, *The Principles of Chemical Equilibrium*, 4th ed., Cambridge University Press, Cambridge, 1981, pp. 287–288; B. Perlmutter-Hayman, *J. Chem. Educ.* **61**, 782 (1984); K. S. Pitzer and L. Brewer, *Thermodynamics*, 2nd ed., McGraw-Hill Book Co., New York, 1961, pp. 245–246.
3. G. Scatchard and W. J. Hamer, *J. Am. Chem. Soc.* **57**, 1805 (1934); G. Scatchard and C. L. Raymond, *J. Am. Chem. Soc.* **60**, 1278 (1938); R. W. Missen, *I&EC Fundamentals* **8**, 81 (1969).
4. O. Redlich and A. T. Kister, *Ind. and Eng. Chem.* **40**, 345 (1948).
5. F. A. Mato, C. Berro, and A. Péneloux, *J. Chem. Eng. Data* **36**, 259 (1991).
6. G. Scatchard, *Chem. Rev.* **44**, 7 (1949).
7. E. A. Guggenheim, *Trans. Faraday Soc.* **33**, 151 (1937).
8. E. A. Guggenheim, *Proc. Roy. Soc. A* **148**, 304 (1935).
9. M. Margules, *Sitzber. Akad. Wiss. Wien [2A]* **104**, 1243 (1895).
10. R. M. Rosenberg and W. L. Peticolas, *J. Chem. Educ.* **81**, 1647–1652 (2004).
11. J. H. Hildebrand and R. L. Scott, *The Solubility of Nonelectrolytes*, 3rd ed., Reinhold Publishing Corporation, New York, 1950.
12. K. Kalali, F. Kohler, and P. Svejda, *J. Chem. Eng. Data* **36**, 326–329 (1991).
13. E. A. Guggenheim, *Thermodynamics*, North Holland Publishing Co., Amsterdam, pp. 200–203, 1967.

## CHAPTER 17

---

# DETERMINATION OF NONELECTROLYTE ACTIVITIES AND EXCESS GIBBS FUNCTIONS FROM EXPERIMENTAL DATA

---

Having established the definitions and conventions for the activity function and for the excess Gibbs function in Chapter 16, we are in a position to understand the experimental methods that have been used to determine numeric values of these quantities.

### 17.1 ACTIVITY FROM MEASUREMENTS OF VAPOR PRESSURE

If the vapor pressure of a substance in solution is sufficiently great to be determined experimentally, the activity can be calculated directly. As the standard state differs for the solvent and solute, each must be considered separately.

#### Solvent

The activity of the solvent is related directly to the vapor pressure when the vapor is an ideal gas. As the pure solvent is the standard state, the chemical potential  $\mu_1$  of the solvent in any solution is given by the expression [Equation (16.1)]

$$\begin{aligned}\mu_1 &= \mu_1^\circ + RT \ln a_1 \\ &= \mu_1^\bullet + RT \ln a_1\end{aligned}$$

where  $\mu_1^\bullet$  is the chemical potential of the pure solvent under its own vapor pressure.

The chemical potential of the solvent in the liquid phase in equilibrium with its vapor is equal to the chemical potential of the solvent vapor. Thus,

$$\mu_1^\bullet + RT \ln a_1 = \mu_{1(\text{gas})}^\circ + RT \ln \frac{p_1}{P_{\text{gas}}^\circ} \quad (17.1)$$

Similarly, for the pure solvent in equilibrium with its vapor

$$\mu_1^\bullet = \mu_{1(\text{gas})}^\circ + RT \ln \frac{p_1^\bullet}{P_{\text{gas}}^\circ} \quad (17.2)$$

Thus, from Equations (17.1) and (17.2), we conclude that

$$a_1 = \frac{p_1}{p_1^\bullet} \quad (17.3)$$

in which  $p_1$  represents the partial pressure of the vapor of the solvent over the solution and  $p_1^\bullet$  represents the vapor pressure of the pure solvent. If the vapor is not ideal, fugacities must be used in place of partial pressures (see Chapter 10).

### Solute

If the solute is sufficiently volatile to allow a determination of its vapor pressure over the solution, its activity also can be calculated from its partial pressure in the vapor. As the chemical potential in the vapor is equal to the chemical potential of the same component in the liquid

$$\begin{aligned} \mu_2 &= \mu_2^\circ + RT \ln a_2 \\ &= \mu_{2(\text{gas})}^\circ + RT \ln \frac{p_2}{P_{\text{gas}}^\circ} \end{aligned} \quad (17.4)$$

provided that the vapor behaves as an ideal gas. If data are available throughout the entire range of composition, and pure solute is chosen as the standard state, then  $\mu_2^\circ$  is equal  $\mu_2^\bullet$ . If a hypothetical standard state is chosen, then  $\mu_2^\circ$  is equal to the chemical potential of the solute in that standard state—that is, the chemical potential the solute would have, either at  $X_2 = 1$  or at  $m_2 = 1$ , if Henry's law described its behavior at that concentration. For the solute in its standard state

$$\mu_2^\circ = \mu_{2(\text{gas})}^\circ + RT \ln \frac{p_2^\circ}{P_{\text{gas}}^\circ} \quad (17.5)$$

where  $p_2^\circ$  is the vapor pressure of the solute vapor in equilibrium with the solution in which the solute is in its standard state. Thus, from Equations (17.4) and (17.5), we conclude that

$$a_2 = \frac{p_2}{p_2^\circ} \quad (17.6)$$

As the Henry's-law standard state is, by definition, hypothetical, we must find a way to determine  $p_2^\circ$  from experimental data.

If the vapor is ideal, Henry's law is expressed, on the molality scale, as

$$p_2 = k_2'' \left( \frac{m_2}{m_2^\circ} \right) \quad (17.7)$$

[see Equation (15.7)]. As  $p_2^\circ$  is the value of  $p_2$  when  $m_2 = m_2^\circ$ ,

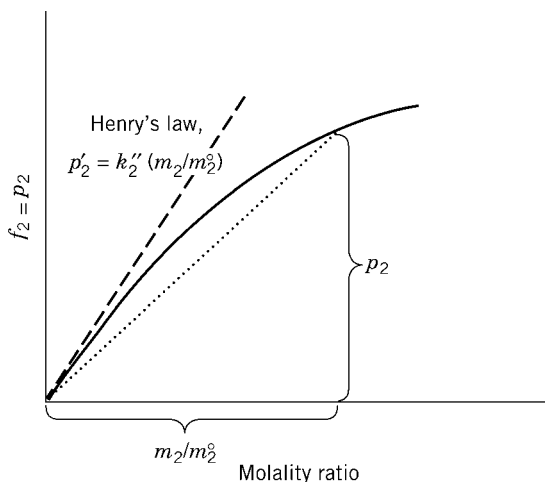
$$p_2^\circ = k_2'' \quad (17.8)$$

We can see from Figure 17.1 that  $k_2''$  is the limiting slope of the curve of  $p_2$  against  $m_2/m_2^\circ$  as  $m_2 \rightarrow 0$ . Thus,

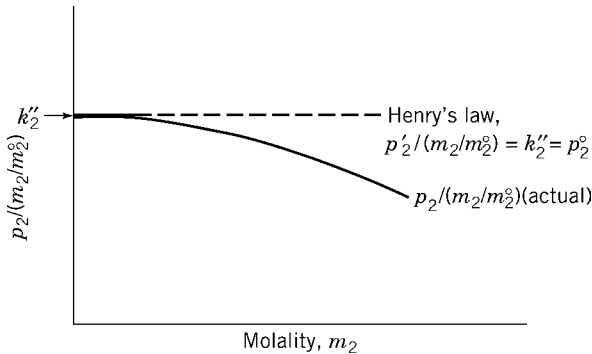
$$\lim_{m_2 \rightarrow 0} \left( \frac{p_2}{m_2/m_2^\circ} \right) = k_2'' = p_2^\circ \quad (17.9)$$

The extrapolation of this ratio to  $m_2 = 0$  is shown in Figure 17.2. The curve in Figure 17.2 should have a horizontal limiting slope. If an experimental curve does not have a horizontal limiting slope, the data have not been obtained in sufficiently dilute solution to show Henry's-law behavior. Very few data are available that satisfy this rigorous criterion [1]. We frequently settle for a condition in which the plot of  $p_2/m_2$  has a clear linear extrapolation to  $m_2 = 0$ , as opposed to a continuing curvature that makes an extrapolation impossible.

Using these equations and the measured partial pressure of the solute in the vapor, we have enough information to calculate the activity of the solute, if



**Figure 17.1.** Partial pressure of solute as function of molality ( $p_2'$  represents the vapor pressure along the broken line) (Henry's law).



**Figure 17.2.** Determination of partial pressure of solute in its standard state.

the vapor behaves as an ideal gas. If the vapor is not ideal, we must use fugacities instead of pressures.

## 17.2 EXCESS GIBBS FUNCTION FROM MEASUREMENT OF VAPOR PRESSURE

Although the description of deviations from ideality in terms of the excess Gibbs function gives us one quantity instead of the two activity coefficients of the two components of a binary solution, we still need to calculate the activity coefficients first, as observed in Equation (16.57).

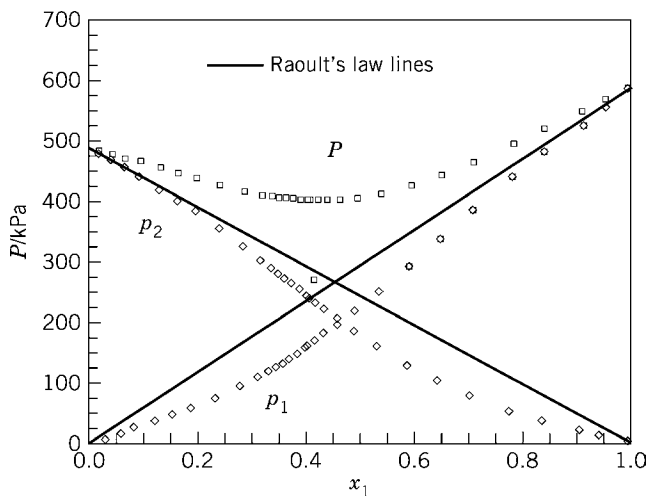
$$\frac{G_m^E}{RT} = X_1 RT \ln \gamma_1 + X_2 RT \ln \gamma_2 \quad (16.57)$$

We shall use the data of Mato et al. [2] for the vapor pressure and vapor composition<sup>1</sup> of mixtures of methyl *tert*-butyl ether [1] and chloroform (2) at 313.15 K to illustrate the procedures used to calculate  $G_m^E$  as a function of composition.<sup>2</sup> These data are plotted in Figure 17.3.

We calculate the activity coefficients based on a Raoult's-law standard state from Equation (17.3) and Equation (16.5), assuming that the vapors are ideal gases. The authors corrected for the small degree of nonideality of the vapors. The results are plotted in Figure 17.4. The data for  $G_m^E$  as a function of  $X_1$  are plotted in Figure 17.5, along with two possible Redlich–Kister functions discussed in Section 16.7.

<sup>1</sup>Some authors prefer to calculate vapor composition from total pressure and liquid composition rather than to measure vapor composition directly. See H. C. Van Ness, *J. Chem. Thermodynamics* **27**, (1995).

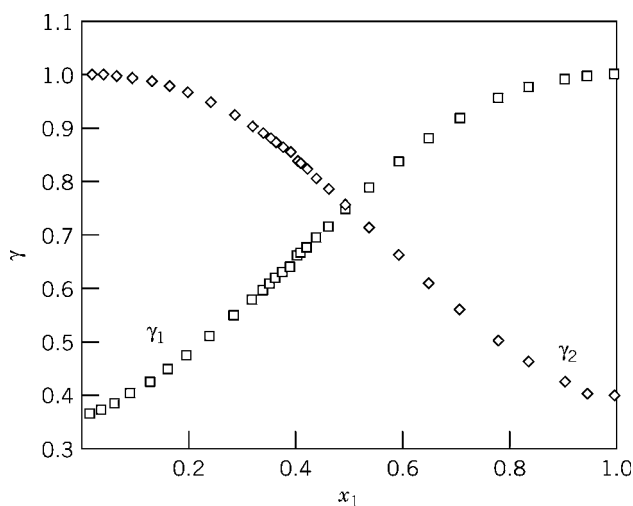
<sup>2</sup>The data for vapor pressure of the pure liquids given in the paper must be multiplied by 10 to be consistent with the vapor pressures of the solutions.



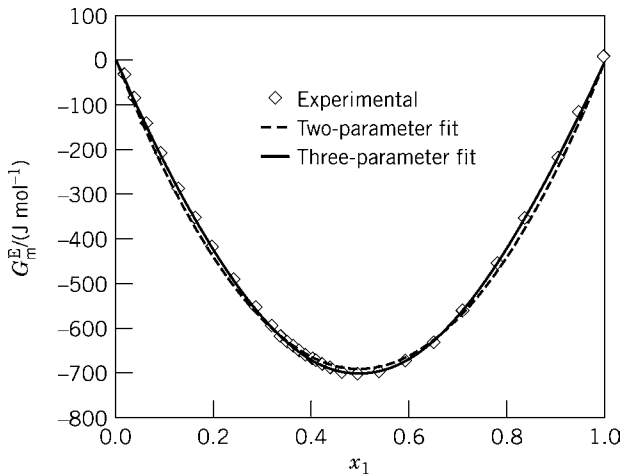
**Figure 17.3.** Data for vapor pressure and composition of solutions of methyl *tert*-butyl ether  $p_1$  and chloroform  $p_2$  at 313.15 K. Data from Ref. 2.

As in Equation (16.69), we can decide what function to fit to the data for  $G_m^E$  by plotting  $\ln(\gamma_1/\gamma_2)$  against  $X_1$ , as in Figure 17.6.

As the plot is not linear, the solution is not regular, and we need to obtain values for  $C$  or  $C$  and  $D$ . As we can observe in Figure 17.5, the fit for a two-parameter

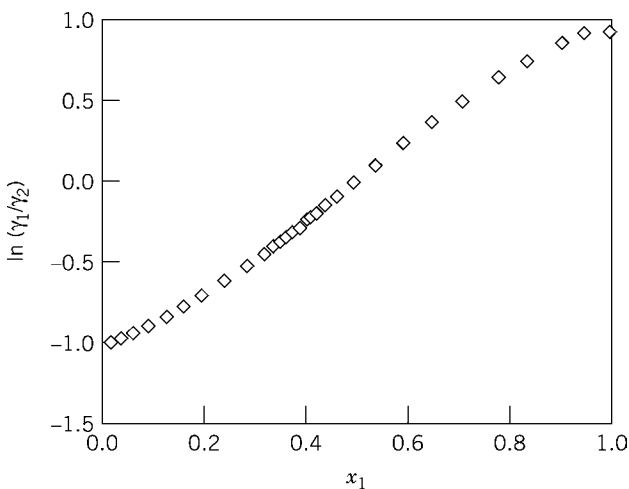


**Figure 17.4.** Activity coefficients of methyl *tert*-butyl ether  $\gamma_1$  and chloroform  $\gamma_2$  as a function of  $X_1$  at 313.15 K. Data from Ref. 2.



**Figure 17.5.** A plot of  $G_m^E$  as a function of  $X_1$  for solutions of methyl *tert*-butyl ether [1] and chloroform [2] as a function of  $X_1$  at 313.15 K. Data from Ref. 2. The two calculated curves compare the fit of a two-parameter function and a three-parameter function of the form proposed by Redlich and Kister.

equation is close, but the fit is much better for a three-parameter equation. A nonlinear least-squares fit (see Section A.1) provides values of  $B = -1.121 \pm 0.002$ ,  $C = 0.029 \pm 0.005$ , and  $D = 0.163 \pm 0.010$ . The negative value of  $B$  is consistent with the minimum in the total vapor pressure.



**Figure 17.6.** A plot of  $\ln(\gamma_1/\gamma_2)$  against  $X_1$  for the solutions described in Figure 17.3.

### 17.3 ACTIVITY OF A SOLUTE FROM DISTRIBUTION BETWEEN TWO IMMISCIBLE SOLVENTS

If the activity of a solute is known in one solvent, then its activity in another solvent immiscible with the first can be determined from the equilibrium distribution of the solute between the two solvents. As an example, let us consider an extreme situation, such as that illustrated in Figure 17.7, in which the shapes of the fugacity curves are different in two different solvents. The limiting behavior at infinite dilution, Henry's law, is indicated for each solution. The graphs reveal that the standard states are different in the two solvents because the hypothetical 1-molal solutions have different fugacities.

If the solute in solution A is in equilibrium with that in solution B, its escaping tendency is the same in both solvents. Consequently, its chemical potential  $\mu_2$  at equilibrium also must be identical in both solvents. Nevertheless, the solute will have different activities in solution A and B since [Equation (16.1)]

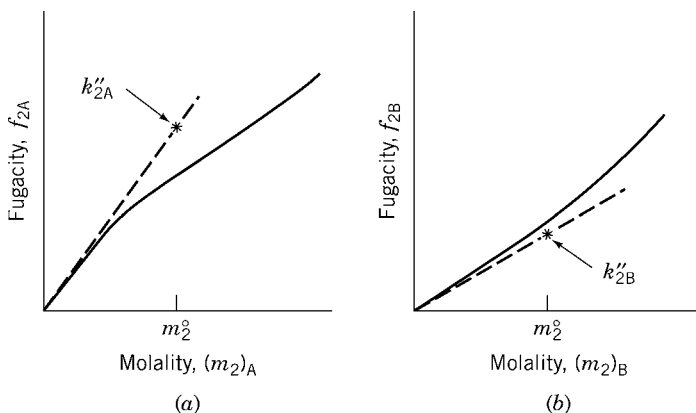
$$\mu_2 = \mu_2^\circ + RT \ln a_2$$

and  $(\mu_2^\circ)_A$  differs from  $(\mu_2^\circ)_B$ . If the activity of the solute is known in one of the solvents, then the activity in the other solvent can be calculated as follows. At equilibrium

$$(\mu_2)_A = (\mu_2)_B \tag{17.10}$$

As

$$(\mu_2)_A = (\mu_2^\circ)_A + RT \ln (a_2)_A$$



**Figure 17.7.** Comparison of fugacity–molality curves for solute in two immiscible solvents; used to determine Henry's law constants.



and

$$(\mu_2)_B = (\mu_2^\circ)_B + RT \ln(a_2)_B$$

it follows from Equation (17.10) that

$$(\mu_2^\circ)_A + RT \ln(a_2)_A = (\mu_2^\circ)_B + RT \ln(a_2)_B$$

or

$$RT \ln \frac{(a_2)_B}{(a_2)_A} = (\mu_2^\circ)_A - (\mu_2^\circ)_B \quad (17.11)$$

Therefore, to calculate  $(a_2)_B$  from  $(a_2)_A$ , we must find the difference between the chemical potentials in the respective standard states. From Equation (15.10)

$$\mu_2^\circ = \mu_{2(\text{gas})}^\circ + RT \ln \left( \frac{k_2''}{f_{\text{gas}}^\circ} \right)$$

Thus,

$$(\mu_2^\circ)_B - (\mu_2^\circ)_A = RT \ln \left[ \frac{(k_2'')_B}{(k_2'')_A} \right] \quad (17.12)$$

and

$$\frac{(a_2)_B}{(a_2)_A} = \frac{(k_2'')_A}{(k_2'')_B} \quad (17.13)$$

To determine the ratio of the activities in the two solvents, then, we need to determine the ratio of the Henry's-law constants for the solute in the two solutions.

For these solutions, from Equation (15.8),

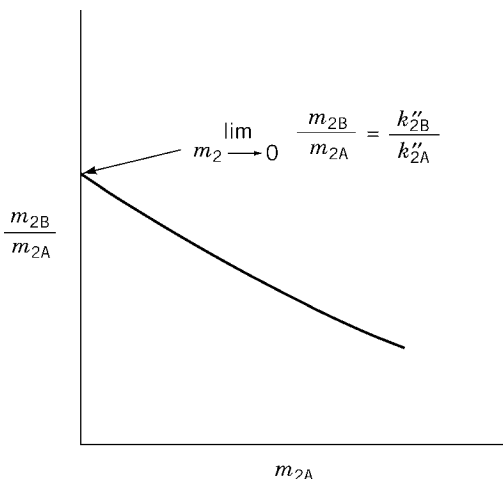
$$\lim_{(m_2)_A \rightarrow 0} \frac{(f_2)_A}{(m_2)_A / m_2^\circ} = (k_2'')_A$$

and

$$\lim_{(m_2)_B \rightarrow 0} \frac{(f_2)_B}{(m_2)_B / m_2^\circ} = (k_2'')_B$$

At equilibrium,  $(f_2)_A = (f_2)_B$ , because both solutions are in equilibrium with the same vapor, and

$$\lim_{m_2 \rightarrow 0} \frac{(m_2)_A}{(m_2)_B} = \frac{(k_2'')_B}{(k_2'')_A} \quad (17.14)$$



**Figure 17.8.** Extrapolation of distribution data to obtain the conversion factor for solute activities.

Thus, Equation (17.13) can be written as

$$(a_2)_B = (a_2)_A \lim_{m_2 \rightarrow 0} \frac{(m_2)_B}{(m_2)_A} \quad (17.15)$$

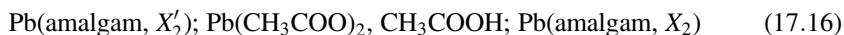
If the activity in one solvent is known as a function of molality, and if the equilibrium molalities in both solvents can be determined for a range of molalities, Equation (17.15) can be used to calculate the activity in the other solvent. A value for

$$\lim_{m_2 \rightarrow 0} \frac{(m_2)_B}{(m_2)_A}$$

is obtained by plotting values of  $(m_2)_B/(m_2)_A$  at equilibrium against  $(m_2)_A$  and by extrapolating to  $(m_2)_A = 0$ , as in Figure 17.8.

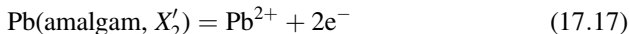
## 17.4 ACTIVITY FROM MEASUREMENT OF CELL POTENTIALS

Although potential measurements are used primarily to determine activities of electrolytes, such measurements can also be used to obtain information on activities of nonelectrolytes. In particular, the activities of components of alloys, which are solid solutions, can be calculated from the potentials of cells such as the following for lead amalgam:

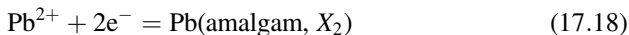


In this cell, two amalgams with different mole fractions of lead act as electrodes in a common electrolyte solution containing a lead salt. The activities of lead in these amalgams can be calculated from emf measurements with this cell.

If we adopt the convention of writing the chemical reaction in the cell as occurring so that electrons will move in the outside conductor from left to right, so that the reaction in the left electrode is an oxidation and the reaction in the right electrode is a reduction, the reaction at the left electrode is



and that at the right electrode is



As the electrolyte containing  $\text{Pb}^{2+}$  is common to both electrodes, the cell reaction, that is, the sum of Reactions (17.17) and (17.18), is



As the two amalgams have the same solvent (mercury), we may choose the same standard state for Pb in each amalgam. We choose a Henry's-law standard state because we have data for dilute amalgams and the solubility of Pb in Hg is limited. Equation (16.18) then will represent the Gibbs function change for Equation (17.19):

$$\Delta G_m = RT \ln \frac{a_2}{a'_2}$$

If concentrations in the alloy are expressed in mole fraction units, then [Equation (16.7)]

$$a_2 = X_2 \gamma_2$$

As, from Equation (7.84),

$$\Delta G = -n\mathcal{F}\mathcal{E}$$

it follows that

$$-n\mathcal{F}\mathcal{E} = RT \ln \frac{a_2}{a'_2} \quad (17.20)$$

$$= RT \ln \frac{X_2 \gamma_2}{a'_2} \quad (17.21)$$

so

$$\mathcal{E} = -\frac{RT}{n\mathcal{F}} \ln X_2 - \frac{RT}{n\mathcal{F}} \ln \gamma_2 + \frac{RT}{n\mathcal{F}} \ln a'_2 \quad (17.22)$$

The potentials are measured for a series of cells in which  $X_2$  is varied and  $X'_2$  is held constant. A typical series of data for lead amalgam is shown in Table 17.1.

To obtain values of  $a_2$  or of  $\gamma_2$  from these data, we rearrange Equation (17.22) to the form

$$\mathcal{E} + \frac{RT}{n\mathcal{F}} \ln X_2 = \frac{RT}{n\mathcal{F}} \ln a'_2 - \frac{RT}{n\mathcal{F}} \ln \gamma_2 \quad (17.23)$$

or

$$\frac{n\mathcal{F}\mathcal{E}}{RT} + \ln X_2 = \ln a'_2 - \ln \gamma_2 \quad (17.24)$$

**TABLE 17.1. Electromotive Force of Pb (amalgam,  $X'_2 = 6.253 \times 10^{-4}$ ); Pb(CH<sub>3</sub>COO)<sub>2</sub>, CH<sub>3</sub>COOH; Pb (amalgam,  $X_2$ ) at 25°C<sup>a</sup> [3]**

$X_2$	$-\mathcal{E}/\text{Volts}$	$n\mathcal{F}\mathcal{E}/RT + \ln X_2$	$1000a_2$	$\gamma$
0.0006253	0.000000	-7.3773	0.6099	0.975
0.0006302	0.000204	-7.3854	0.6197	0.983
0.0009036	0.0004636	-7.3700	0.8750	0.968
0.001268	0.008911	-7.3640	1.220	0.962
0.001349	0.009659	-7.3603	1.294	0.959
0.001792	0.013114	-7.3453	1.693	0.945
0.002055	0.014711	-7.3327	1.917	0.933
0.002744	0.018205	-7.3155	2.516	0.917
0.002900	0.018886	-7.3132	2.653	0.915
0.003086	0.019656	-7.3110	2.817	0.913
0.003203	0.020068	-7.3059	2.909	0.908
0.003729	0.021827	-7.2908	3.335	0.894
0.003824	0.022111	-7.2877	3.410	0.892
0.004056	0.022802	-7.2826	3.598	0.887
0.004516	0.023954	-7.2649	3.936	0.872
0.005006	0.025160	-7.2557	4.323	0.864
0.005259	0.025692	-7.2478	4.506	0.857
0.005670	0.026497	-7.2353	4.798	0.846
0.006085	0.027256	-7.2237	5.090	0.836
0.006719	0.028340	-7.2090	5.538	0.824
0.007858	0.029951	-7.1778	6.278	0.799
0.007903	0.030010	-7.1767	6.306	0.798
0.008510	0.030771	-7.1619	6.691	0.786
0.009737	0.032062	-7.1277	7.399	0.760
0.01125	0.033437	-7.0903	8.234	0.732
0.01201	0.033974	-7.0668	8.586	0.715
0.01388	0.035226	-7.0195	9.465	0.682
0.01406	0.035323	-7.0142	9.537	0.678
0.01456	0.035609	-7.0015	9.751	0.670
0.01615	0.036375	-6.9575	10.35	0.641
0.01650(satd)	0.036394	-6.9375	10.37	0.628

<sup>a</sup>M. M. Haring, M. R. Hatfield, and P. P. Zapponi, *Trans. Electrochem. Soc.* **75**, 473 (1939).

The left side of Equation (17.24) is evaluated from the data in Table 17.1, with  $n = 2$ , because two electrons are transferred per Pb transferred. Then this quantity is plotted against  $X_2$  and extrapolated to  $X_2 = 0$ , as in Figure 17.9.

We can write a limiting form of Equation (17.24)

$$\lim_{x_2 \rightarrow 0} \left[ \frac{n\mathcal{F}\mathcal{E}}{RT} + \ln X_2 \right] = \ln a'_2 \tag{17.25}$$

Then the extrapolated value from Figure 17.9 is equal to  $\ln a'_2$ . By a least-squares fit of the most dilute points, which are essentially linear, we obtain a value of  $-7.3983 \pm 0.0016$ .

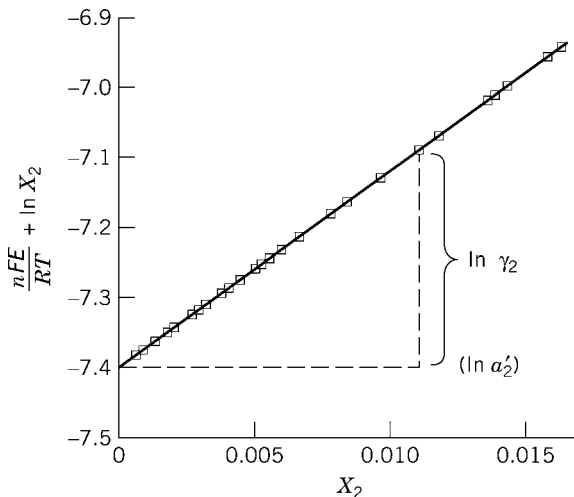
Once  $a'_2$  is known,  $a_2$  can be determined at various mole fractions from Equation (17.20) in the form

$$\mathcal{E} - \frac{RT}{n\mathcal{F}} \ln a'_2 = -\frac{RT}{n\mathcal{F}} \ln a_2$$

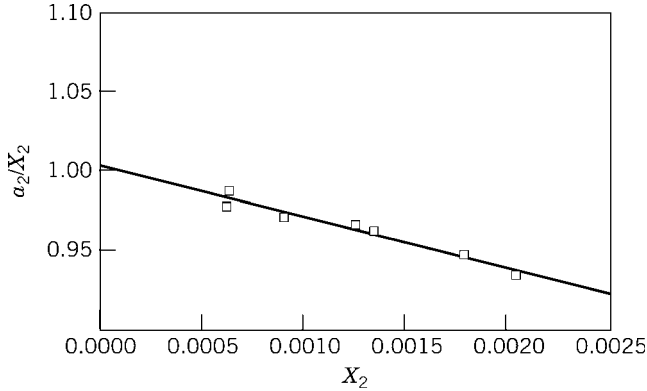
The results for the lead amalgams of the cell in Equation (17.16) are assembled in Table 17.1. The activity coefficients also have been calculated. The graphical representation of  $\ln \gamma_2$  is shown in the body of Figure 17.9.

From Equations (16.7) and (16.17), we can write

$$\lim_{x_2 \rightarrow 0} \gamma_2 = \lim_{x_2 \rightarrow 0} \frac{a_2}{X_2} = 1$$



**Figure 17.9.** Extrapolation of cell potential data from Table 17.1 to obtain a constant to calculate activities of lead in lead amalgams.



**Figure 17.10.** A plot to test whether we can use Henry's law to define a standard state for lead in lead amalgams. Data from Table 17.1.

To test whether we really observe limiting behavior, we plot  $a_2/X_2$  against  $X_2$ , as in Figure 17.10.

A rigorous test would require that we have points in very dilute solution with values of  $a_2/X_2$  equal to 1. We shall be satisfied with a linear extrapolation by least-squares analysis of the seven-most dilute points to an intercept of  $1.0029 \pm 0.0033$ , which is equal to 1 within experimental error.

## 17.5 DETERMINATION OF THE ACTIVITY OF ONE COMPONENT FROM THE ACTIVITY OF THE OTHER

The fundamental relationship between the chemical potentials of the two components of a solution at a fixed temperature and pressure is the Gibbs–Duhem Equation (9.34):

$$n_1 d\mu_1 + n_2 d\mu_2 = 0$$

From the relationship of the chemical potential to the activity [Equation (16.1)], we can write Equation (9.34) as

$$n_1 d \ln a_1 + n_2 d \ln a_2 = 0 \quad (17.26)$$

If Equation (17.26) is divided by  $(n_1 + n_2)$ , the result is

$$X_1 d \ln a_1 + X_2 d \ln a_2 = 0 \quad (17.27)$$

### Calculation of Activity of Solvent from That of Solute

If adequate data are available for the activity of the solute, the activity of the solvent can be obtained by rearranging Equation (17.27) to

$$d \ln a_1 = -\frac{X_2}{X_1} d \ln a_2 \quad (17.28)$$

and integrating. As  $a_2$  approaches zero as  $X_2$  approaches zero,  $\ln a_2$  is an indeterminate quantity at one of the limits of integration. Although both  $a_2$  and  $X_2$  approach zero, their ratio  $a_2/X_2 = \gamma_2$  approaches one [Equation (16.3)]. Thus, it is necessary to convert Equation (17.28) into a corresponding equation for the activity coefficients.

As

$$X_1 + X_2 = 1$$

then

$$dX_1 = -dX_2$$

and

$$\frac{dX_1}{X_1} = -\frac{dX_2}{X_1} = -\frac{X_2}{X_1} \frac{dX_2}{X_2}$$

or

$$d \ln X_1 = -\frac{X_2}{X_1} d \ln X_2 \quad (17.29)$$

The subtraction of Equation (17.29) from Equation (17.28) gives the expression

$$d \ln \frac{a_1}{X_1} = -\frac{X_2}{X_1} d \ln \frac{a_2}{X_2} \quad (17.30)$$

or

$$d \ln \gamma_1 = -\frac{X_2}{X_1} d \ln \gamma_2 \quad (17.31)$$

Integrating Equation (17.31) from the infinitely dilute solution to some finite concentration, we obtain, with the assumption of a Raoult's-law standard state for the solvent and a Henry's-law standard state for the solute,

$$\int_0^{\ln \gamma_1} d \ln \gamma_1 = - \int_0^{\ln \gamma_2} \frac{X_2}{X_1} d \ln \gamma_2$$

and

$$\ln \gamma_1 = - \int_0^{\ln \gamma_2} \frac{X_2}{X_1} d \ln \gamma_2 \quad (17.32)$$

If  $X_2/X_1$  is plotted against  $\ln \gamma_2$ , the integration of Equation (17.32) can be carried out graphically, or a numeric integration can be performed directly from tabulated values of  $X_2/X_1$  and  $\ln \gamma_2$ . (See Appendix A.)

### Calculation of Activity of Solute from That of Solvent

To calculate the activity of the solute from that of the solvent, it is useful to rearrange Equation (17.31) to the form

$$d \ln \gamma_2 = -\frac{X_1}{X_2} d \ln \gamma_1 \quad (17.33)$$

which, on integration, gives

$$\ln \gamma_2 = -\int_0^{\ln \gamma_1} \frac{X_1}{X_2} d \ln \gamma_1 \quad (17.34)$$

However, the integral in Equation (17.34) is divergent because  $X_1/X_2$  approaches infinity in the limit of infinitely dilute solutions.

One method of overcoming this difficulty is as follows. Instead of setting the lower limit in the integration of Equation (17.33) at infinite dilution, let us use a temporary lower limit at a finite concentration  $X'_2$ . Thus, in place of Equation (17.34), we obtain

$$\ln \frac{\gamma_2}{\gamma'_2} = -\int_{\ln \gamma'_1}^{\ln \gamma_1} \frac{X_1}{X_2} d \ln \gamma_1 \quad (17.35)$$

The evaluation of the integral in Equation (17.35) offers no difficulties because  $X_1/X_2$  is finite at the lower limit. Using Equation (17.35), we can obtain precise values of the ratio  $\gamma_2/\gamma'_2$  as a function of  $X_2$ . If  $\gamma_2/\gamma'_2$  is plotted against  $X_2$ , for a solution of water in dimethyl sulfoxide [4], as shown in Figure 17.11, where the reference solution with  $X'_2$  equal to 0.0365 was chosen, the values can be extrapolated to a finite-limiting value.

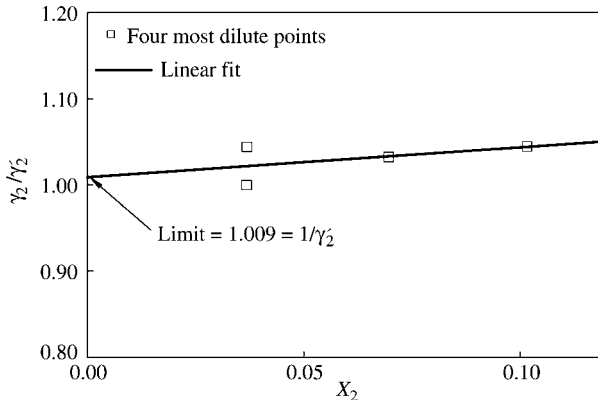
From Equations (16.3) and (16.7), we know that, if Henry's law is followed,

$$\lim_{x_2 \rightarrow 0} \frac{a_2}{X_2} = \lim_{x_2 \rightarrow 0} \gamma_2 = 1$$

Thus,

$$\lim_{x_2 \rightarrow 0} \frac{\gamma_2}{\gamma'_2} = \frac{1}{\gamma'_2} \quad (17.36)$$





**Figure 17.11.** Extrapolation of relative activity coefficients to obtain  $1/\gamma_2^0$  for the calculation of solute activity coefficients. Data from Ref. 4. Dimethyl sulfoxide is the solvent, and water is the solute.

Once a value for  $\gamma_2^0$ , 0.9911 in this case, is obtained by extrapolation, values for  $\gamma_2$  in each of the other solutions can be calculated from the values of  $\gamma_2/\gamma_2^0$  using Equation (17.35).

The activity of the solvent often can be obtained by an experimental technique known as the “isopiestic method” [5]. With this method we compare solutions of two different nonvolatile solutes; for one of which, the reference solution, the activity of the solvent has been determined previously with high precision. If both solutions are placed in an evacuated container, solvent will evaporate from the solution with higher vapor pressure and condense into the solution with lower vapor pressure until equilibrium is attained. The solute concentration for each solution then is determined by analysis. Once the molality of the reference solution is known, the activity of the solvent in the reference solution can be read from records of previous experiments with reference solutions. As the standard state of the solvent is the same for all solutes, the activity of the solvent is the same in both solutions at equilibrium. Once the activity of the solvent is known as a function of  $m_2$  for the new solution, the activity of the new solute can be calculated by the methods discussed previously in this section.

## 17.6 MEASUREMENTS OF FREEZING POINTS

Perhaps the method of most general applicability for determining activities of nonelectrolytes in solutions is the one based on measurements of the lowering of the freezing point of a solution. As measurements are made of the properties of the solvent, activities of the solute are calculated by methods described in the preceding section.

Elaborate procedures have been developed for obtaining activity coefficients from freezing-point and thermochemical data. However, to avoid duplication, the details will not be outlined here, because a completely general discussion, which is applicable to solutions of electrolytes as well as to nonelectrolytes, is presented in Chapter 21 of the Third Edition of this book [6].

## EXERCISES

- 17.1.** The data in Table 17.2 for the partial pressures (in mm Hg) of toluene and of acetic acid at 69.94 °C have been taken from Ref. 7. For the purposes of this exercise, assume that the partial pressure of each component is identical with its fugacity.
- Draw a graph of  $f_1$  versus  $X_1$ . Indicate Raoult's law by a dotted line.
  - Draw a graph of  $f_2$  versus  $X_2$ . Indicate Raoult's law by a dotted line. Plot  $f_2/X_2$  against  $X_2$  to observe whether the data permit a Henry's-law standard state to be used. If permissible, draw the Henry's-law line and calculate the Henry's-law constant for acetic acid in toluene.
  - If the calculation in (b) suggests the use of a Henry's-law standard state, calculate the activities and activity coefficients of acetic acid on the basis of a  $k_2$  established from Henry's law [see Equation (15.1)]. Plot these values against  $X_2$ .

**TABLE 17.2. Partial Pressures of Toluene and Acetic Acid at 69.94°C**

$X_1$ (Toluene)	$X_2$ (Acetic Acid)	$p_1$ /(mm Hg) (Toluene)	$p_2$ /(mm Hg) (Acetic Acid)
0.0000	1.0000	0.0	136.0
0.1250	0.8750	54.8	120.5
0.2310	0.7690	84.8	110.8
0.3121	0.6879	101.9	103.0
0.4019	0.5981	117.8	95.7
0.4860	0.5140	130.7	88.2
0.5349	0.4651	137.6	83.7
0.5912	0.4088	154.2 <sup>a</sup>	78.2
0.6620	0.3380	155.7	69.3
0.7597	0.2403	167.3	57.8
0.8289	0.1711	176.2	46.5
0.9058	0.0942	186.1	30.5
0.9565	0.0435	193.5	17.2
1.0000	0.0000	202.0	0.0

<sup>a</sup>This figure evidently is a typographical error. The correct figure is near 145.2. It also is likely (D. H. Volman, private correspondence) that the International Critical Tables did not interpret correctly the mole fraction scale used by the original investigator [8].

**TABLE 17.3. Vapor Pressure and Composition for Solutions of Methyl *t*-Butyl Ether and Acetonitrile at 313.15 K.**

$X_1$	$y_1$	$P$	$X_1$	$y_1$	$P$
0.0000	0.0000	22.706	0.4000	0.6877	54.292
0.0122	0.1237	25.649	0.4561	0.7055	55.501
0.0189	0.1642	26.581	0.6203	0.7614	58.511
0.0263	0.2039	28.254	0.6891	0.7870	59.548
0.0339	0.2484	29.580	0.7381	0.8067	60.134
0.0485	0.2975	31.691	0.7792	0.8252	60.532
0.0669	0.3725	34.065	0.8278	0.8504	60.864
0.1036	0.4549	38.213	0.8539	0.8651	60.971
0.1406	0.5089	41.593	0.8810	0.8831	61.023
0.1652	0.5431	43.786	0.9119	0.9064	60.918
0.2110	0.5847	46.582	0.9360	0.9268	60.747
0.2372	0.6035	48.003	0.9540	0.9443	60.544
0.2490	0.6120	48.659	0.9673	0.9588	60.343
0.2773	0.6291	49.940	0.9781	0.9716	60.138
0.3060	0.6439	51.084	0.9846	0.9801	60.000
0.3262	0.6536	51.814	0.9902	0.9868	59.882
0.3501	0.6646	52.644	1.0000	1.0000	59.766
0.3742	0.6747	53.389			

- d. Calculate the activities and activity coefficients of acetic acid when the pure liquid is taken as the standard state. Plot these values on the same graph as in (c).
- e. Calculate the activities and activity coefficients of toluene, the solvent in these solutions, using a Raoult's-law standard state.
- 17.2.** The data in Table 17.3 are for vapor pressure and vapor and liquid composition of solutions of methyl *tert*-butyl ether (1) and acetonitrile (2), (9). The symbol  $X_1$  represents the mole fraction of (1) in the liquid phase, and  $y_1$  represents the mole fraction of (1) in the vapor phase.  $P$  is the equilibrium vapor pressure of the solution. The temperature is 313.15 K.
- a. Calculate the partial pressure of each component, and plot the partial pressures and the total pressure against  $X_1$  on the same graph. Assume that the partial pressures are a good approximation for the fugacities.
- b. Plot  $p/X$  against  $X$  for each component to see whether Raoult's law, Henry's law, or both are justified by the data for a choice of standard state. Whichever is justified, draw the appropriate lines in the graph in (a).
- c. Calculate the activities and activity coefficients justified by the data, and plot them against  $X_1$ .
- d. Calculate  $G_m^E$ , and plot the values against  $X_1$ .
- e. Calculate  $\ln \gamma_1/\gamma_2$ , and plot the results against  $X_1$ .

**TABLE 17.4. Equilibrium Pressures and Liquid Composition for Solutions of Water in Dimethyl Sulfoxide**

$X_D$	$p/\text{torr}$	$P_D$	$P_w$
0	20.991	0	20.991
0.01013	20.750	0.0003	20.750
0.02994	20.301	0.0011	20.300
0.05004	19.794	0.0021	19.792
0.07242	19.226	0.0033	19.223
0.09065	18.602	0.0048	18.597
0.09596	18.511	0.0050	18.507
0.1264	17.431	0.0082	17.429
0.1585	16.201	0.013	16.189
0.1965	14.632	0.021	14.613
0.2325	13.114	0.031	13.088
0.2744	11.432	0.047	11.387
0.3130	9.989	0.065	9.925
0.3551	8.584	0.089	8.496
0.4011	7.251	0.119	7.133
0.4373	6.358	0.144	6.214
0.4772	5.490	0.173	5.318
0.5205	4.692	0.205	4.487
0.5689	3.933	0.241	3.692
0.6375	3.049	0.292	2.757
0.6636	2.778	0.310	2.468
0.6860	2.453	0.332	2.121
0.7337	2.120	0.358	1.762
0.7754	1.793	0.385	1.408
0.8098	1.546	0.406	1.140
0.8381	1.362	0.424	0.938
0.8673	1.181	0.441	0.740
0.8984	1.009	0.458	0.551
0.9304	0.848	0.475	0.373
0.9631	0.692	0.492	0.200
0.9632	0.684	0.493	0.191
1.000	0.512	0.512	0

- f. On the basis of the plot in (e), choose an appropriate Redlich–Kister polynomial to describe the dependence of  $G_m^E$  on  $X_1$ . Plot the function on the graph in (d). Comment on the relationship between the sign of  $B$  and the maximum in the vapor pressure curve.

**17.3.** Table 17.4 lists the mole fraction of dimethyl sulfoxide in solutions of water (2) in dimethyl sulfoxide (1), the total pressure, and the partial pressures of water and dimethyl sulfoxide (4).

- a. Calculate the activities  $a_1$  and activity coefficients  $\gamma_1$  of dimethyl sulfoxide using a Raoult's-law standard state.
- b. Plot  $X_1/X_2$  against  $\ln \gamma_1$ .
- c. Compute  $\gamma_2/\gamma_2'$  by numeric integration (see Appendix A), with 0.0368 as the value of  $X_2$  for  $\gamma_2'$ . Compute  $\gamma_2$  at the same points.
- d. Compute  $\gamma_2$  at the same points using a Henry's-law standard state. Calculate  $K_H$  for dimethyl sulfoxide from a plot of  $p_2/X_2$  against  $X_2$ . Plot both sets of values of  $\gamma_2$  on the same graph.

#### 17.4. Potentials [10] of the cell

$\text{In}(\text{amalgam}, X_2), 0.01\text{ m HClO}_4, 0.01\text{ m In}(\text{SO}_4)_3, \text{aq.}, \text{Pt}, \text{H}_2 [\text{g}, p(\text{H}_2)]$

at 25.0°C are given in Table 17.5, where  $X_2$  is the only quantity that varies [10].

- a. Plot  $\mathcal{E}$  versus  $X_2$ . Note the difficulty in choosing a limit as  $X_2$  approaches zero.
- b. Write the Nernst equation for the cell, and rearrange it so that all the known variables are on one side. Designate the sum of all the constant terms on the other side as  $\mathcal{E}''$ .
- c. Plot  $(n\mathcal{F}\mathcal{E})/(RT) + \ln X_2$  against  $X_2$ , and extrapolate the initial linear portion of the curve to  $X_2 = 0$  to obtain the value of  $\ln a_2'$ .

**TABLE 17.5. Cell Potentials for Indium Amalgam Cell at 25.0°C**

$X_2$	$\mathcal{E}/\text{V}$
0.7000	0.2667
0.6441	0.26430
0.6360	0.26303
0.5222	0.25895
0.5000	0.25831
0.3998	0.25180
0.3040	0.24550
0.3000	0.24535
0.2000	0.23706
0.1626	0.23470
0.1000	0.22646
0.0841	0.22331
0.0500	0.21790
0.0388	0.21440
0.0100	0.20144
0.00920	0.20068
0.000940	0.17900

**TABLE 17.6. Vapor Pressures and Compositions for Solutions of 1,1,2-trichlorotrifluoroethane and *n*-Hexane at 308.15 K**

$X_1$ (liquid)	$X_1$ (vapor)	$P$ (total)/kPa
0	0	30.735
0.0199	0.0558	31.953
0.0417	0.1107	33.203
0.0648	0.1629	34.508
0.0775	0.1903	35.184
0.1080	0.2486	36.688
0.1630	0.3393	39.445
0.2288	0.4288	42.435
0.2923	0.5002	45.087
0.3283	0.5377	46.568
0.3845	0.5884	48.703
0.4519	0.6432	51.034
0.5217	0.6940	53.274
0.5959	0.7442	55.509
0.6241	0.7625	56.321
0.7209	0.8228	58.978
0.7771	0.8572	60.391
0.8462	0.8994	62.059
0.9048	0.9363	63.452
0.9366	0.9568	64.123
0.9741	0.9819	64.952
1	1	65.403

- d. Calculate the activities and activity coefficients of indium in the amalgams.
- 17.5.** At 42.05°C, the enthalpy of mixing of one mole of water and one mole of ethanol is  $-82.0$  cal. The vapor pressure of water above the solution is  $0.821 p_1^\bullet$  and that of ethanol is  $0.509 p_2^\bullet$ .
- Calculate the entropy of mixing for this solution.
  - Compute the excess entropy above that for the mixing of two components that form an ideal solution.
- 17.6.** Fenclová and Dohnal [11] have measured the liquid and vapor compositions and total pressures of solutions of 1,1,2-trichlorotrifluoroethane (Freon) [1] and *n*-hexane[2] at 308.15 K. Their results are given in Table 17.6.
- Calculate activity coefficients for both components on the basis of Raoult's-law standard states.
  - Are the data adequate to determine activity coefficients on the basis of Henry's-law standard states?
  - Calculate  $G_m^E$ , and plot the values against  $X_1$ .

- d. Calculate  $\ln \gamma_1/\gamma_2$ , and plot the results against  $X_1$ .
- e. On the basis of the plot in (d), choose an appropriate Redlich–Kister polynomial to describe the dependence of  $G_m^E$  on  $X_1$ . Plot the function on the graph in (c). Calculate  $G_m^E$  for each solution from the best polynomial.

## REFERENCES

1. R. M. Rosenberg and W. L. Peticolas, *J. Chem. Educ.* **81**, 1647–1652 (2004).
2. Reprinted from F. A. Mato, C. Berro, and A. Péneloux, *J. Chem. Eng. Data* **36**, 259 (1991). Copyright 1991 American Chemical Society.
3. The use of a spreadsheet to produce Table 17.1 has been described by R. M. Rosenberg and E. V. Hobbs, *J. Chem. Educ.* **62**, 140 (1985).
4. J. T. W. Lai, F. W. Lau, D. Robb, P. Westh, G. Nielson, C. Trandum, A. Hvidt, and Y. Koga *J. Solution Chem.* **24**, 89–97 (1995).
5. See, for example, G. N. Lewis and M. Randall *Thermodynamics*, 2nd ed. (revised by K. S. Pitzer and L. Brewer), McGraw-Hill, New York, 1961, pp. 320–323; H. F. Holmes, C. F. Baes, Jr., and R. E. Mesmer, *J. Chem. Thermodynamics* **11**, 1035 (1979).
6. I. M. Klotz and R. M. Rosenberg, *Chemical Thermodynamics*, 3rd ed., Benjamin/Cummings, Menlo Park, CA, 1972, pp. 374–383.
7. *International Critical Tables*, Vol. III, pp. 217, 223, and 288, McGraw-Hill, New York, 1926.
8. J. von Zawidski, *Z. Physik. Chem.* **35**, 129 (1900).
9. Reprinted with permission from F. A. Mato and C. Berro, *J. Chem. Eng. Data* **36**, 262 (1991). Copyright 1991 American Chemical Society.
10. Reprinted with permission from J. N. Butler, *J. Phys. Chem.* **68**, 1828 (1964). Copyright 1964 American Chemical Society.
11. D. Fenclová and V. Dohnal, *J. Chem. Thermodynamics* **23**, 911 (1991).

## CHAPTER 18

---

# CALCULATION OF PARTIAL MOLAR QUANTITIES AND EXCESS MOLAR QUANTITIES FROM EXPERIMENTAL DATA: VOLUME AND ENTHALPY

---

In this chapter, we shall consider the methods by which values of partial molar quantities and excess molar quantities can be obtained from experimental data. Most of the methods are applicable to any thermodynamic property  $J$ , but special emphasis will be placed on the partial molar volume and the partial molar enthalpy, which are needed to determine the pressure and temperature coefficients of the chemical potential, and on the excess molar volume and the excess molar enthalpy, which are needed to determine the pressure and temperature coefficients of the excess Gibbs function. Furthermore, the volume is tangible and easy to visualize; hence, it serves well in an initial exposition of partial molar quantities and excess molar quantities.

### 18.1 PARTIAL MOLAR QUANTITIES BY DIFFERENTIATION OF $J$ AS A FUNCTION OF COMPOSITION

The calculation of partial molar quantities, defined [as in Equation (9.12)] as

$$J_{mi} = \left( \frac{\partial J}{\partial n_i} \right)_{T,P,n_j} \quad (18.1)$$

requires the differentiation of  $J$  as a function of composition.

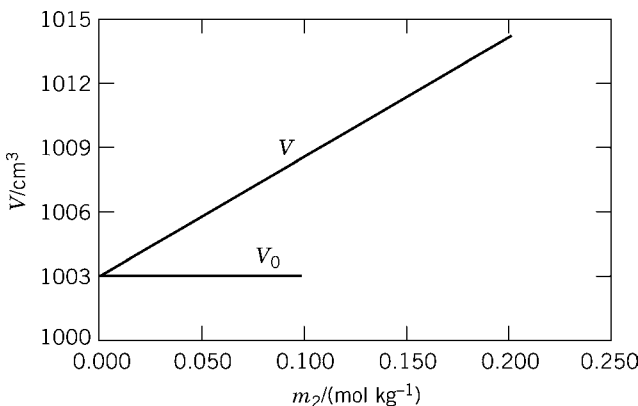


A particularly simple case is shown in Figure 18.1, in which the volume is a linear function of the mole number of glycolamide in a kilogram of water. In this case, the partial molar volume of solute  $V_{m2}$  is constant and is equal to the slope of the line. The partial molar volume  $V_{m2}$  represents the effective volume of the solute in solution, that is, the increase in volume per mole of solute added. From Equation (9.27), written for the volume function,

$$V = n_1 V_{m1} + n_2 V_{m2} \quad (18.2)$$

The linear dependence of  $V$  on  $n_2$  at constant  $n_1$  also indicates that  $V_{m1}$  is constant and is equal to  $V_{m1}^*$ , the molar volume of pure solvent.

In general, the value of  $V_{m2}$  is not equal to the molar volume of pure solute. For example, glycolamide (Figure 18.1) has an effective volume  $V_{m2}$  in a dilute aqueous solution of  $56.2 \text{ cm}^3 \text{ mol}^{-1}$ ; the pure solid has a molar volume of  $54.0 \text{ cm}^3 \text{ mol}^{-1}$ . For iodine,  $V_{m2}$  as a solute in liquid perfluoro-*n*-heptane is  $100 \text{ cm}^3 \text{ mol}^{-1}$ , whereas the solid has a molar volume of  $51 \text{ cm}^3 \text{ mol}^{-1}$ , and the supercooled liquid has a molar volume of  $59 \text{ cm}^3 \text{ mol}^{-1}$ . Hydrogen has an effective volume in aqueous solution, at 101.32 kPa (1 atm) and  $25^\circ\text{C}$ , of  $26 \text{ cm}^3 \text{ mol}^{-1}$ , in contrast to approximately  $25,000 \text{ cm}^3 \text{ mol}^{-1}$  for the pure gas. Furthermore,  $V_{m2}$  for hydrogen (as well as for many other solutes) varies greatly with solvent; it is  $50 \text{ cm}^3 \text{ mol}^{-1}$  in ether and  $38 \text{ cm}^3 \text{ mol}^{-1}$  in acetone. Even more surprising are the effective volumes of some salts in water. For NaCl, the molar volume of the crystal is  $27 \text{ cm}^3 \text{ mol}^{-1}$  compared with  $16.4 \text{ cm}^3$  for  $V_{m2}$ . For  $\text{Na}_2\text{CO}_3$ , the molar volume of the pure solid is about  $42 \text{ cm}^3 \text{ mol}^{-1}$  compared with  $-6.7 \text{ cm}^3 \text{ mol}^{-1}$  for  $V_{m2}$ ; that is,  $\text{Na}_2\text{CO}_3$  dissolved in water has a *negative* effective volume. These observations show very clearly that  $V_{m2}$  reflects not only the volume of the solute molecule, but also the effect that the solvent–solute interaction has on the volume of the solvent.



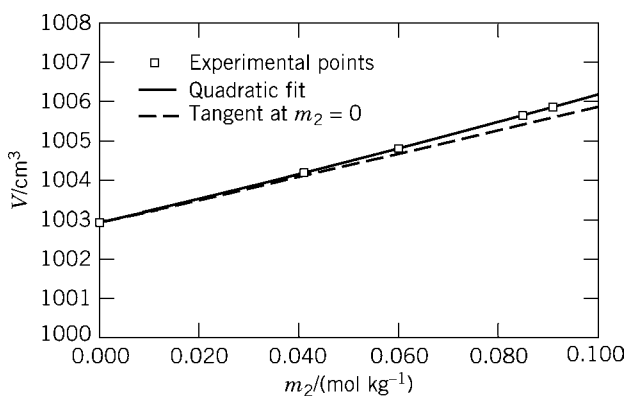
**Figure 18.1.** Linear dependence of volume on concentration for dilute solutions of glycolamide in water. Based on data of Gucker et al. [1].

## Partial Molar Volume

For most solutions, the volume is not a linear function of the composition; the slope of the volume-concentration curve and the value of  $V_{m2}$  are functions of the composition, as illustrated in Figure 18.2. In this case, it can be observed that the volume does not change by equal increments when equal quantities of solute are added successively to a fixed quantity of solvent.

Thus, let us consider what must be the significance of the slope  $(\partial V/\partial n_2)_{n_1, T, P}$  represented by the dashed line in Figure 18.2. According to the principles of calculus, this slope represents the change in volume per mole of added solute  $n_2$  (temperature, pressure, and moles of solvent  $n_1$  being maintained constant) at a fixed point on the curve—in other words, at some specified value of  $n_2$ . As the mass of solvent is 1 kg,  $n_2$  is numerically equal to the molality  $m_2$ . The value of  $n_2$  must be specified because the slope depends on the position on the curve at which it is measured. In practice, this slope, which we represent by  $V_{m2}$ , as in Equation (18.1), refers to either one of the following two experiments.

1. Measure the change in total volume  $V$  of the solution when one mole of solute is added to a very large quantity (strictly speaking, an infinite quantity) of the solution at the desired concentration. Because very large quantities of solution are used, the addition of one mole of solute does not change the concentration of the solution appreciably. As in the description of equilibrium in Chapter 10, we may refer to the “infinite copy model.”
2. Measure the change in total volume  $V$  of the solution when a small quantity of the solute is added to the solution. Then calculate the change for one mole (that is, divide  $\Delta V$  by  $\Delta n_2$ ) as if no change in composition occurred when a whole mole of solute was added. Repeat this procedure, but add a smaller quantity  $\Delta n_2'$  of solute and compute  $\Delta V'/\Delta n_2'$ . Repeat again with a still smaller quantity



**Figure 18.2.** Nonlinear dependence of volume on molality for dilute solutions of sulfuric acid ( $\text{H}_2\text{SO}_4$ ) in water ( $\text{H}_2\text{O}$ ). Based on data of I. M. Klotz and C. F. Eckert, *J. Am. Chem. Soc.* **64**, 1878 (1942).

of added solute. The limiting value

$$\lim_{\Delta n_2 \rightarrow 0} \frac{\Delta V}{\Delta n_2} = \left( \frac{\partial V}{\partial n_2} \right)_{T,P,n_1} \quad (18.3)$$

gives  $V_{m_2}$ .

These are two equivalent points of view concerning the meaning of  $V_{m_2}$ . Clearly,  $V_{m_2}$  does not correspond to the actual change in volume when a whole mole of solute is added to a limited quantity of solution because  $V_{m_2}$  is the increase in  $V$  upward along the dotted line in Figure 18.2, whereas the actual volume follows the solid line. To calculate  $V_{m_2}$  from the data represented in Figure 18.2, numerical or graphical differentiation is necessary, or the data can be fitted to a polynomial equation as in the procedures described in Appendix A.

Most frequently, volume data for solutions are tabulated as density  $\rho$  as a function of composition. The procedure for obtaining  $V_{m_2}$  is illustrated by reference to the densities and weight percent concentrations of ethanol–water mixtures (Table 18.1, Columns 1 and 4 at 25°C).

To obtain  $V_{m_2}$ , that is,  $(\partial V/\partial n_2)_{n_1,T,P}$ , we need values of  $V$  for a fixed quantity  $n_1$  of water and for variable quantities  $n_2$  of ethanol. For this purpose we convert the relative weights given in Column 1 to relative numbers of moles, that is, to  $n_2/n_1$  in Column 2. The numbers in Column 2 also are the moles of ethanol accompanying one mole of water in each of the solutions listed in Column 1.

From this information and the density (Column 4), we can calculate the volume in cubic centimeters that contains one mole of water. The mass of a solution containing  $n_2$  moles of ethanol and one mole of water is

$$\text{mass} = \frac{n_2}{n_1} \times M(\text{C}_2\text{H}_5\text{OH}) + 1 \times M(\text{H}_2\text{O}) \quad (18.4)$$

where  $M$  is the molar mass. Hence, the volume per mole of water is

$$V = \frac{\text{mass}}{\rho} \text{cm}^3 (\text{mole H}_2\text{O})^{-1} \quad (18.5)$$

Numeric values for these volumes of solution that contain a fixed quantity (one mole) of water are listed in Column 5. The partial molar volumes can be determined by computing the derivative of the quantity in Column 5, the volume of a quantity of solution containing one mole of water and varying moles of ethanol, with respect to the number of moles of ethanol per mole of water, the quantity in Column 2.

Numeric values for the volumes of solution containing a fixed quantity (one mole) of ethanol are listed in Column 7. The partial molar volumes can be determined by computing the derivative of the quantity in Column 7, the volume of a quantity of solution containing one mole of ethanol and varying moles of water, with respect to the number of moles of water per mole of ethanol, the quantity in Column 3.

**TABLE 18.1. Densities and Partial Volumes of Ethanol–Water Mixtures<sup>a</sup>**

	1	2	3	4	5	6	7	8
Mass % C <sub>2</sub> H <sub>5</sub> OH		$\frac{\text{C}_2\text{H}_5\text{OH}}{\text{H}_2\text{O}} = \frac{n_2}{n_1}$	$\frac{\text{H}_2\text{O}}{\text{C}_2\text{H}_5\text{OH}} = \frac{n_1}{n_2}$	$\rho$ g cm <sup>-3</sup>	V cm <sup>3</sup> (mol H <sub>2</sub> O) <sup>-1</sup>	$\frac{\Delta V}{\Delta n_2}$	V cm <sup>3</sup> (mol C <sub>2</sub> H <sub>5</sub> OH) <sup>-1</sup>	$\frac{\Delta V}{\Delta n_1}$
20		0.097761	10.2290	0.96639	23.3024		238.3603	
25		0.130349	7.67174	0.95895	25.0488	53.59	192.1677	18.063
30		0.167591	5.96691	0.95067	27.0717	54.32	161.5345	17.968
35		0.210563	4.74917	0.94146	29.4394	55.10	139.8126	17.838
40		0.260697	3.83587	0.93148	32.2344	55.75	123.6468	17.700
45		0.319947	3.12552	0.92085	35.5707	56.31	111.1770	17.555
50		0.391046	2.55725	0.90985	39.6008	56.68	101.2690	17.435
55		0.477945	2.09229	0.89850	44.5567	57.03	93.2257	17.299
60		0.586569	1.70483	0.88699	50.7768	57.26	86.5658	17.188
65		0.726228	1.37698	0.87527	58.8076	57.50	80.9769	17.047
70		0.912440	1.09596	0.86340	69.5522	57.70	76.2266	16.904

<sup>a</sup>Data from N. S. Osborne, E. C. McKelvy, and H. W. Bearce, *Bull. Bureau Stand.* **9**, 327 (1913).

One way to perform this calculation is to fit the data to a polynomial by the method of least squares (see Section A.1) and to differentiate that function. A quartic fit of the data for one mole of water and varying moles of ethanol yields the function

$$V = 18.187 + 50.997 n_2/n_1 + 14.592 (n_2/n_1)^2 \\ - 15.0949 (n_2/n_1)^3 + 5.9914 (n_2/n_1)^4$$

This equation yields an expression for  $V_{m2}$

$$V_{m2} = 50.997 + 29.18 n_2/n_1 \\ - 45.285 (n_2/n_1)^2 + 23.966 (n_2/n_1)^3$$

A quartic fit of the data for one mole of ethanol and varying moles of water yields the function

$$V = 57.930 + 16.451 n_1/n_2 + 0.2312 (n_1/n_2)^2 \\ - 0.01571 (n_1/n_2)^3 + 0.0004360 (n_1/n_2)^4$$

This equation yields an expression for  $V_{m1}$

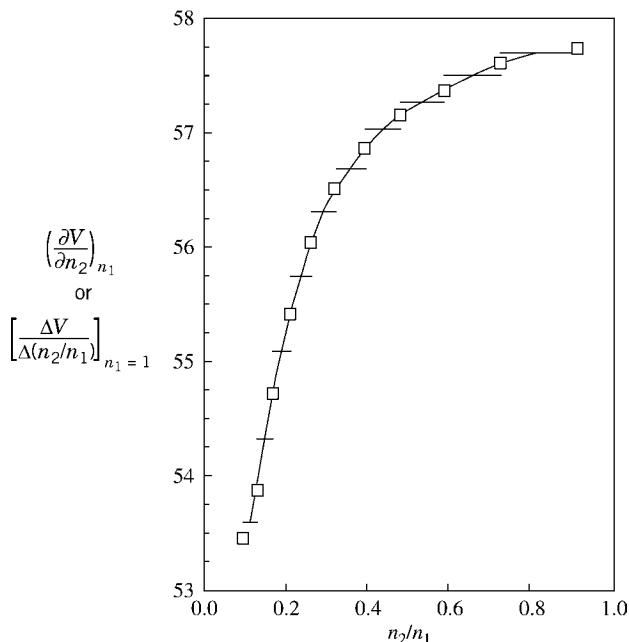
$$V_{m1} = 16.451 + 0.4624 n_1/n_2 \\ - 0.04713 (n_1/n_2)^2 + 0.001090 (n_1/n_2)^3$$

The values of  $V_{m2}$  can also be determined graphically from a chord-area plot (see Section A.2) of the ratio of increments listed in Column 6 versus  $n_2/n_1$  because

$$\left( \frac{\Delta V}{\Delta n_2} \right)_{n_1} = \left( \frac{\Delta V}{\Delta (n_2/n_1)} \right)_{n_1=1} \quad (18.6)$$

Figure 18.3 shows a curve of the derivative calculated from the quartic best fit of  $V$  as a function of  $n_1/n_2$ , which are points from a numeric differentiation, and chords from a graphical differentiation, which show good agreement among the three methods. In the graphical differentiation, the partial derivative  $(\partial V/\partial n_2)_{n_1, T, P}$  can be determined from a smooth curve drawn through the chords so that the sum of the areas above the chords is equal to the sum of the areas below the chords. Clearly the graphical differentiation that requires careful plotting on a very large graph to match the precision of the data is less convenient than computer fitting of the volume data to a function followed by differentiation.

The partial molar volumes for water in the ethanol solutions can be calculated by analogous procedures. An interesting alternative method is the tangent method [2].



**Figure 18.3.** Graphical differentiation to obtain  $V_{m2}$  in ethanol–water solution compared with derivative of quartic fit of  $V$  as function of  $n_2/n_1$  and numeric differentiation. The solid curve represents the result of differentiation of a fitted quartic polynomial of  $V$  as a function of  $n_2/n_1$ . The squares represent the results of a numeric differentiation. The horizontal lines represent a graphical differentiation.

### Partial Molar Enthalpy

Absolute values of partial molar enthalpies cannot be determined, just as absolute values of enthalpies cannot be determined. Thus, it is necessary to choose some state as a reference and to express the partial molar enthalpy relative to that reference state. The most convenient choice for the reference state usually is the infinitely dilute solution. Without committing ourselves to this choice exclusively, we will nevertheless use it in most of our problems.

The relative values of partial molar enthalpies are used so frequently that it has become customary to use the special symbol  $L_{mi}$  to represent them. Thus,  $L_{mi}$ , which is the relative partial molar enthalpy, is defined by the equation

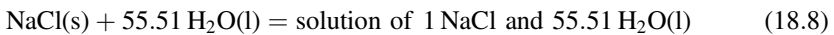
$$L_{mi} = H_{mi} - H_{mi}^{\circ} \quad (18.7)$$

in which  $H_{mi}^{\circ}$  is the partial molar enthalpy of component  $i$  in the standard state, that is, the infinitely dilute solution. For the solvent,  $H_{m1}^{\circ}$  equals  $H_{m1}^{\bullet}$ , which is the molar enthalpy of the pure solvent. For the solute,  $H_{m2}^{\circ}$  generally does not equal  $H_{m2}^{\bullet}$ , which is the molar enthalpy of the pure solute.

Relative partial molar enthalpies also can be visualized in terms of a diagram, such as Figure 18.4. Although the absolute position of  $H_{m1}$  or  $H_{m1}^\circ$  on the enthalpy scale cannot be specified, the difference between them can be determined.

### Enthalpies of Mixing

Experimental data from which relative partial molar enthalpies can be calculated consist of enthalpy changes for mixing processes, which are commonly those that give *integral heats of solution*. An example of an integral heat of solution is the enthalpy change for the process of dissolving one mole of NaCl in 1000 g (55.51 moles) of pure  $H_2O$  to give a 1-molal solution, as shown by Equation (18.8):



For such a process

$$\Delta H = H_{\text{final}} - H_{\text{initial}} \quad (18.9)$$

For any extensive thermodynamic property of a solution [Equation (9.27)]

$$J = n_1 J_{m1} + n_2 J_{m2}$$

Thus,

$$\Delta H = H_{\text{final}} - H_{\text{initial}} = n_1 H_{m1} + n_2 H_{m2} - n_1 H_{m1}^\bullet - n_2 H_{m2}^\bullet \quad (18.10)$$

in which  $H_{m1}^\bullet$  and  $H_{m2}^\bullet$  are the molar enthalpies of pure solvent and pure solute, respectively. As  $H_{m1}^\circ = H_{m1}^\bullet$ ,

$$\begin{aligned} \Delta H &= n_1(H_{m1} - H_{m1}^\circ) + n_2(H_{m2} - H_{m2}^\bullet) \\ &= n_1 L_{m1} + n_2(H_{m2} - H_{m2}^\bullet) \end{aligned} \quad (18.11)$$

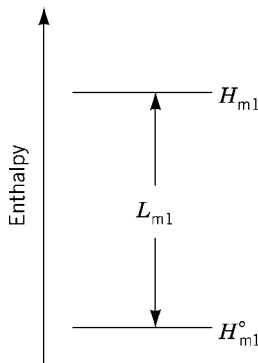


Figure 18.4. Relative partial molar enthalpy.

If we add  $(H_{m2}^\circ - H_{m2}^\circ)$  to the preceding equation, we obtain

$$\begin{aligned}\Delta H &= n_1 L_{m1} + n_2 [H_{m2} - H_{m2}^\circ (H_{m2}^\bullet - H_{m2}^\circ)] \\ &= n_1 L_{m1} + n_2 (H_{m2} - H_{m2}^\circ) - n_2 (H_{m2}^\bullet - H_{m2}^\circ)\end{aligned}$$

or

$$\Delta H = n_1 L_{m1} + n_2 L_{m2} - n_2 L_{m2}^\bullet \quad (18.12)$$

Differentiation of Equation (18.12) term by term with respect to  $n_1$  at constant  $n_2$  yields

$$\left(\frac{\partial \Delta H}{\partial n_1}\right)_{n_2} = L_{m1} + n_1 \left(\frac{\partial L_{m1}}{\partial n_1}\right)_{n_2} + n_2 \left(\frac{\partial L_{m2}}{\partial n_1}\right)_{n_2} \quad (18.13)$$

From the Gibbs–Duhem equation [Equation (9.33)]

$$n_1 dL_{m1} + n_2 dL_{m2} = 0 \quad (18.14)$$

Consequently, the last two terms of Equation (18.13) are equal to zero, so that

$$\left(\frac{\partial \Delta H}{\partial n_1}\right)_{n_2} = L_{m1} \quad (18.15)$$

If  $\Delta H$  is plotted against  $n_1$  at constant  $n_2$ , a graphical differentiation by the chord-area method will yield  $L_{m1}$  as a function of composition. Alternatively, the data could be fitted to a polynomial and the derivative of that polynomial then could be computed.

Differentiation of Equation (18.12) with respect to  $n_2$  at constant  $n_1$  yields

$$\begin{aligned}\left(\frac{\partial \Delta H}{\partial n_2}\right)_{n_1} &= n_1 \left(\frac{\partial L_{m1}}{\partial n_2}\right)_{n_1} + n_2 \left(\frac{\partial L_{m2}}{\partial n_2}\right)_{n_1} + L_{m2} - L_{m2}^\bullet \\ &= L_{m2} - L_{m2}^\bullet\end{aligned} \quad (18.16)$$

because the Gibbs–Duhem equation eliminates the first two terms of the equation. To obtain  $L_{m2}$  from the experimental data, it is necessary to have a value of  $L_{m2}^\bullet$ , which is the relative partial molar enthalpy of the pure solute.

As

$$\lim_{n_2 \rightarrow 0} L_{m2} = 0$$

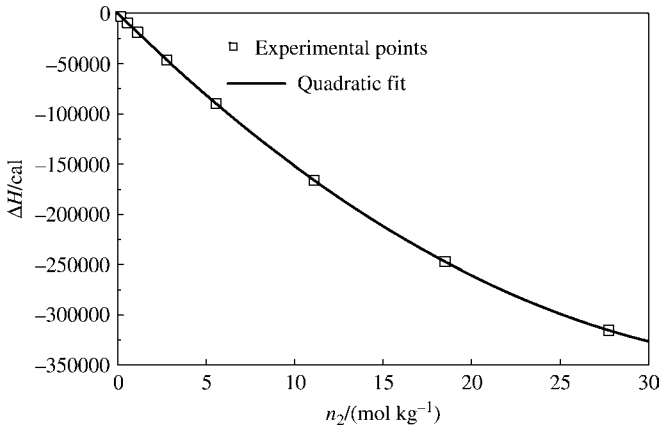
we can observe that

$$\lim_{n_2 \rightarrow 0} \left(\frac{\partial \Delta H}{\partial n_2}\right)_{n_1} = -L_{m2}^\bullet \quad (18.17)$$

From the limiting value of the slope of a  $\Delta H$  versus  $n_2$  plot, it is possible to calculate  $L_{m2}^\bullet$ . It follows that  $L_{m2}$  at any concentration can be evaluated from

$$L_{m2} = \left(\frac{\partial \Delta H}{\partial n_2}\right)_{n_1} - \lim_{n_2 \rightarrow 0} \left(\frac{\partial \Delta H}{\partial n_2}\right)_{n_1} \quad (18.18)$$





**Figure 18.5.** Enthalpy of solution of  $n_2$  moles of gaseous HCl in 1 kg of  $H_2O$ . Based on data from Ref. 3.

Lewis and Randall [3] have recalculated some of Thomsen's data on the heat absorbed when  $n_2$  moles of gaseous HCl is dissolved in 1000 g of  $H_2O$ . A plot of  $\Delta H$  as a function of  $n_2$  at constant  $n_1$  is shown in Figure 18.5.

To find  $L_{m2}$  it is necessary to calculate  $(\partial\Delta H/\partial n_2)_{n_1, T, P}$  at various molalities of HCl. The data in Figure 18.5 have been fitted to a quadratic polynomial by the method of least squares.<sup>1</sup> The equation obtained is

$$\Delta H = (13.33 \pm 18.52) - (17375 \pm 7)n_2 + (216.94 \pm 0.41)(n_2)^2$$

Therefore

$$\lim_{n_2 \rightarrow 0} \frac{d\Delta H}{dn_2} = 17375 \text{ cal mol}^{-1}$$

Hence, the relative partial molar enthalpies of HCl in aqueous solutions can be expressed by the equation

$$\begin{aligned} L_{m2} &= \left( \frac{\partial\Delta H}{\partial n_2} \right)_{n_1} + 17,375 \\ &= -17,375 + 432n_2 + 17,375 \\ &= 432 n_2 = 432 m_2 \end{aligned} \quad (18.19)$$

Thus, for a 10-molal solution, the value of  $L_{m2}$  can be calculated from Equation (18.19) as

$$L_{m2} = [432 \text{ cal (mol kg}^{-1})^{-1}][10.0 \text{ mol kg}^{-1}] = 4320 \text{ cal}$$

<sup>1</sup>We can tabulate values of  $\Delta(\Delta H)/(\Delta n_2)$ ,  $\Delta(\Delta\Delta H)/(\Delta n_2)$ , and  $\Delta(\Delta\Delta\Delta H)/\Delta n_2$  and find that the third quantity varies randomly about zero, which is a behavior that indicates that the second derivative of  $\Delta H$  with respect to  $n_2$  is constant within experimental error, or we can fit the data to polynomials of successively higher powers until no significant improvement in standard deviation occurs for the coefficients.

Although Thomsen's data provide a basis for illustrating this method of calculation, they imply a relationship between  $\Delta H$  and  $m_2$  at low molalities that is probably not an accurate description of the system. A better functional relationship, which is based on more modern data, will be discussed in Chapter 19.

### Enthalpies of Dilution

Relative partial molar enthalpies can also be obtained from measurements of enthalpies of dilution. Humphrey et al. [4] have used enthalpy of dilution measurements to calculate relative partial molar enthalpies in aqueous solutions of amino acids. Their data for  $\Delta H_{\text{dil}}$  of aqueous solutions of serine are shown in Table 18.2, where  $m_i$  is the initial molality of the solution,  $m_f$  is the molality after addition of a small amount of solvent, and  $\Delta H_{\text{dil}}$  is equal to the measured  $\Delta H$  divided by  $n_2$ , which is the number of moles of solute in the solutions.

If the initial solution contains  $n_1$  moles of solvent and  $n_2$  moles of solute, and if  $n'_1$  moles of solvent are added,

$$\begin{aligned}\Delta H &= (n_1 + n'_1)H_{m1f} + n_2H_{m2f} - (n_1H_{m1i} + n_2H_{m2i} + n'_1H_{m1}^\bullet) \\ &= n_1(H_{m1f} - H_{m1i}) + n_2(H_{m2f} - H_{m2i}) + n'_1(H_{m1f} - H_{m1}^\bullet)\end{aligned}\quad (18.20)$$

If we add  $(H_{m1}^\circ - H_{m1}^\bullet)$  to the first parenthesis and  $(H_{m2}^\circ - H_{m2}^\bullet)$  to the second parenthesis, the result is

$$\Delta H = L_{m2f} - L_{m2i}\quad (18.21)$$

and

$$\Delta H_{\text{dil}} = \frac{\Delta H}{n_2} = \frac{L_{m2f}}{n_2} - \frac{L_{m2i}}{n_2}\quad (18.22)$$

**TABLE 18.2. Enthalpies of Dilution of Aqueous Solutions of Serine [4]**

$m_i$	$m_f$	$\Delta H_{\text{dil}}$	$m_i$	$m_f$	$\Delta H_{\text{dil}}$
3.8317	1.7044	583.3	0.7716	0.3774	227.8
3.0292	1.3788	527.5	0.7716	0.5114	146.1
3.0292	0.8927	735.2	0.7716	0.2480	312.9
2.0104	0.9482	434.8	0.5862	0.3879	118.2
1.8084	0.8541	411.6	0.5862	0.2876	181.7
1.8084	0.5592	573.6	0.5862	0.1919	244.9
1.6801	0.7986	393.2	0.3829	0.1900	124.1
1.0127	0.4912	279.4	0.3829	0.1258	170.4
1.0127	0.3237	386.3			

If we assume that  $L_{m2}/n_2$  can be expressed as a polynomial in the molality  $m$ ,

$$\frac{L_{m2}}{n_2} = A_1m + A_2m^2 + A_3m^3 + \dots \quad (18.23)$$

then

$$\Delta H_{\text{dil}} = A_1(m_f - m_i) + A_2(m_f^2 - m_i^2) + A_3(m_f^3 - m_i^3) + \dots \quad (18.24)$$

The constants in Equations (18.23) and (18.24) can be determined by fitting  $\Delta H_{\text{dil}}$  to a function of  $m_f - m_i$  with a least-squares fitting procedure (Section A.2). The appropriate degree of the polynomial is found by increasing the number of terms as long as the sum of square deviations decreases significantly. The results for the data in Table 18.2 for a cubic polynomial are as follows:  $A_1 = -723 \pm 5.5 \text{ J mol}^{-1} (\text{mol kg}^{-1})^{-1}$ ,  $A_2 = 137 \pm 3.4 \text{ J mol}^{-1} (\text{mol kg}^{-1})^{-2}$ , and  $A_3 = -12 \text{ J mol}^{-1} (\text{mol kg}^{-1})^{-3}$ . Then, from Equation (18.23)

$$L_{m2} = n_2A_1m + n_2A_2m^2 + n_2A_3m^3 + \dots \quad (18.25)$$

But,

$$n_2 = n_1M_1m \quad (18.26)$$

where  $M_1$  is the molar mass (in kg) of the solvent. Therefore, for 1 kg of solvent, in which case  $n_1 = 1/M_1$ ,

$$\begin{aligned} L &= n_1M_1A_1m^2 + n_1M_1A_2m^3 + n_1M_1A_3m^4 + \dots \\ &= A_1m^2 + A_2m^3 + A_3m^4 + \dots \end{aligned} \quad (18.27)$$

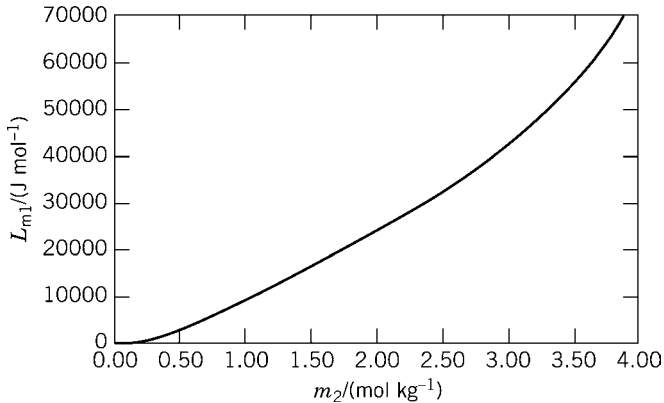
Then,

$$L_{m2} = \left(\frac{\partial L}{\partial n_2}\right)_{T,P,n_1} = \left(\frac{\partial L}{\partial m}\right)_{T,P,n_1=1/M_1} = 2A_1m + 3A_2m^2 + 4A_3m^3 + \dots \quad (18.28)$$

Of course, the expression for  $L_{m2}$  is independent of the amount of solvent, because it is an intensive variable. Then, for 1 kg of solvent, with  $n_2 = m$  and  $n_1 = 1/M_1$ ,

$$\begin{aligned} L_{m1} &= \frac{L - n_2L_{m2}}{n_1} \\ &= \frac{1}{n_1} [A_1m^2 + A_2m^3 + A_3m^4 - n_2(2A_1m + 3A_2m^2 + 4A_3m^3)] \\ &= M_1(A_1m^2 + A_2m^3 + A_3m^4 - 2A_1m^2 - 3A_2m^3 - 4A_3m^4) \\ &= -M_1(A_1m^2 + 2A_2m^3 + 3A_3m^4) \end{aligned} \quad (18.29)$$

The values of  $L_{m1}$  and  $L_{m2}$  calculated from Equations (18.28) and (18.29) are plotted in Figures (18.6) and (18.7).



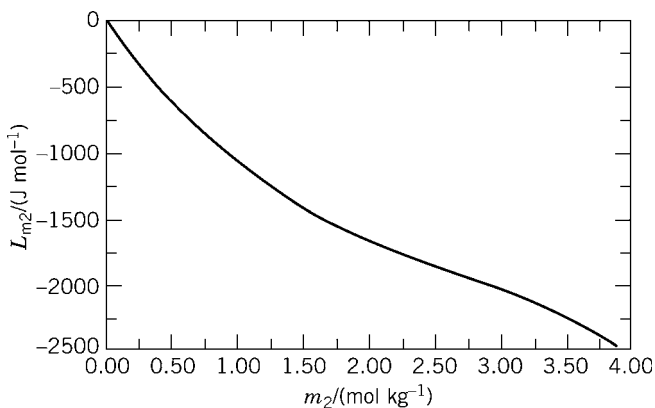
**Figure 18.6.** Relative partial molar enthalpy of water in serine solutions. Data from Ref. 4.

Some authors (4,5,6,9,10) have used the apparent molar quantity  $\Phi J_2$ , where

$$\begin{aligned}\Phi J_2 &= \frac{J - J_0}{n_2} \\ &= \frac{J - n_1 J_{m1}^\bullet}{n_2}\end{aligned}\quad (18.30)$$

The apparent molar enthalpy  $\Phi H_2$  has been used to derive relative partial molar enthalpies from enthalpy of dilution data. The apparent molar enthalpy is defined as

$$\Phi H_2 = \frac{H - n_1 H_{m1}^\bullet}{n_2}\quad (18.31)$$



**Figure 18.7.** Relative partial molar enthalpy of serine in aqueous solutions. Data from Ref. 3.

and the apparent relative molar enthalpy is

$$\Phi L_2 = \frac{L - n_1 L_{m1}^\bullet}{n_2} = \frac{L}{n_2} \quad (18.32)$$

because  $L_{m1}^\bullet$  is equal to zero. The procedure that we have described for the treatment of enthalpy of dilution data is more direct, however. In addition, whenever the value of  $\Phi J_2$  can be expressed as a polynomial in  $m$ ,

$$\Phi J_2 = a + bm + cm^2 \quad (18.33)$$

the value of  $J$  for a solution containing 1 kg of solvent can also be expressed as a polynomial in  $m$ , because then  $n_2 = n_1 M_1 m$ , and  $n_1 = 1/M_1$ .

$$\begin{aligned} J &= n_2 \Phi J_2 + n_1 J_{m1}^\bullet \\ &= am + bm^2 + cm^3 + \frac{J_{m1}^\bullet}{M_1} \end{aligned} \quad (18.34)$$

## 18.2 PARTIAL MOLAR QUANTITIES OF ONE COMPONENT FROM THOSE OF ANOTHER COMPONENT BY NUMERICAL INTEGRATION

Rearrangement of Equation (9.33) leads to

$$dJ_{m1} = -\frac{n_2}{n_1} dJ_{m2} \quad (18.35)$$

This equation can be integrated from the infinitely dilute solution ( $n_2 = 0$ ) to any finite concentration to give

$$\int_{J_{m1}^\circ}^{J_{m1}} dJ_{m1} = \int_{J_{m2}^\circ}^{J_{m2}} \frac{n_2}{n_1} dJ_{m2}$$

or

$$J_{m1} - J_{m1}^\circ = - \int_{J_{m2}^\circ}^{J_{m2}} \frac{n_2}{n_1} dJ_{m2} \quad (18.36)$$

in which  $J_{m1}^\circ$  represents the partial molar quantity of the solvent at infinite dilution of the solute, that is, pure solvent in its standard state. (For example, for water at room temperature,  $V_{m1}^\circ = V_m^\bullet = 18 \text{ cm}^3 \text{ mol}^{-1}$ .)  $J_{m2}^\circ$  is the partial molar quantity of the solute in its standard state, which is the hypothetical standard state extrapolated along the Henry's-law line. For both volume and enthalpy, the standard-state quantity has the same value as the quantity at infinite dilution. [See Equations (16.34) and (16.38).]

### Partial Molar Volume

When  $V_{m2}$  is available as a function of the composition (that is, as a function of  $n_2$  at fixed  $n_1$ ), it is possible to calculate  $V_{m1}$  by numerical integration (see Section A.2) of Equation (18.39), applied specifically to volumes:

$$V_{m1} - V_{m1}^\circ = - \int_{V_{m2}^\circ}^{V_{m2}} \frac{n_2}{n_1} dV_{m2} \quad (18.37)$$

Values of  $n_2/n_1$  are plotted against  $V_{m2}$ , as in Figure 18.8, and a numerical integration is carried out from tabulated values of  $n_2/n_1$  and  $V_{m2}$ . If the intervals  $\Delta V_{m2}$  are sufficiently small

$$\Sigma \left( \frac{\bar{n}_2}{n_1} \right) \Delta V_{m2} \cong \int_{V_{m2}^\circ}^{V_{m2}} \frac{n_2}{n_1} dV_{m2} \quad (18.38)$$

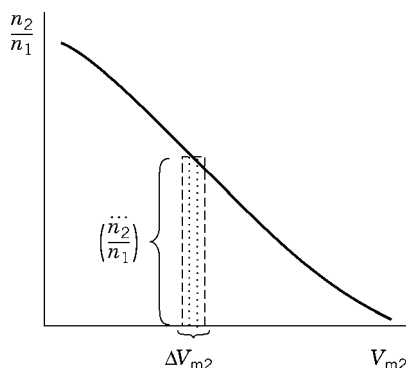
in which  $(\bar{n}_2/n_1)$  represents the average value of this ratio in the interval  $\Delta V_{m2}$ . As  $V_{m1}^\circ$  is the molar volume of pure solvent, it can be calculated from the known molar mass and density of the pure solvent.

### Partial Molar Enthalpy

If Equation (18.37) is applied to relative partial molar enthalpies

$$L_{m1} - L_{m1}^\circ = L_{m1} = - \int_{L_{m2}^\circ}^{L_{m2}} \frac{n_2}{n_1} dL_{m2} \quad (18.39)$$

By the same numerical procedure described for partial molar volumes, the relative partial molar enthalpies of solvent can be evaluated from the values for the solute.



**Figure 18.8.** Sketch of data for numerical integration to determine  $V_{m1}$  from  $V_{m2}$ .

### 18.3 ANALYTIC METHODS FOR CALCULATION OF PARTIAL MOLAR PROPERTIES

When the value of an intensive property  $J$  can be expressed as an algebraic function of the composition, the partial molar quantities can be determined analytically.

#### Partial Molar Volume

In the case of valine in water [5] at 298.15 K and 1 atm, for example,  $V$  (the volume of solution in cubic decimeters for 1000 g of water) can be expressed in terms of the following series in the molality  $m_2$ :

$$V = 0.9999999 + 0.0920377 m_2 + 0.00022207 m_2^2 \quad (18.40)$$

or

$$V = 0.9999999 + 0.0920377 n_2 + 0.00022207 n_2^2 \quad (18.41)$$

The value of  $V_{m2}$  can be obtained by differentiation, because the quantity of solvent is fixed:

$$\begin{aligned} V_{m2} &= \left( \frac{\partial V}{\partial n_2} \right)_{n_1} \\ &= 0.920377 + 0.00044414 m_2 \\ &= 0.920377 + 0.00044414 n_2 \end{aligned} \quad (18.42)$$

where  $n_2$  is the number of moles of solute in 1 kg of solvent.

The partial molar volume of the solvent  $V_{m1}$  can be obtained by the integration illustrated in Equation (18.37). To evaluate  $dV_{m2}$  we merely need to differentiate Equation (18.42):

$$dV_{m2} = 0.00044414 dn_2 \quad (18.43)$$

Substituting from Equation (18.43) into Equation (18.37), we have

$$V_{m1} - V_{m1}^\bullet = - \int_{V_{m2}^\bullet}^{V_{m2}} \frac{n_2}{n_1} dV_{m2} = - \int_0^{n_2} \frac{n_2}{n_1} 0.00044414 dn_2 \quad (18.44)$$

As  $n_1 = 1000/18.02 = 55.51$  and as  $V_{m1}^\bullet = 18.08 \text{ cm}^3 \text{ mol}^{-1}$

$$\begin{aligned} V_{m1} &= 18.08 - \frac{1}{n_1} \int_0^{n_2} 0.00044414 n_2 dn_2 \\ &= 18.08 - \frac{00022207}{55.51} n_2^2 \\ &= 18.08 - 4.00054 \times 10^{-6} n_2^2 \\ &\quad \text{(for 1000 g of solvent)} \\ &= 18.08 - 4.00054 \times 10^{-6} m_2^2 \end{aligned} \quad (18.45)$$

### Partial Molar Enthalpy

Values of  $L_{m1}$  for the HCl solutions for which  $L_{m2}$  is given in Equation (18.19) also can be obtained by analytical integration of Equation (18.19):

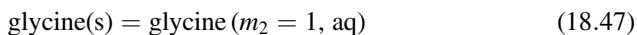
$$\begin{aligned} L_{m1} &= -\frac{1}{55.51} \int_0^{m_2} m_2 (432 \, dm_2) \\ &= -3.89 m_2^2 \text{ (cal mol}^{-1}\text{)} \end{aligned} \quad (18.46)$$

## 18.4 CHANGES IN $J$ FOR SOME PROCESSES IN SOLUTIONS

We need to consider two kinds of processes involving solutions, other than chemical changes. One kind is a *transfer* or *differential* process, and the other is a *mixing* or an *integral* process.

### Transfer Process

Consider the equation



An infinitesimal transfer of glycine from the solid phase to the solution at constant temperature, pressure, and composition of solution results in a corresponding change  $dJ$  in the thermodynamic property  $J$  of the system composed of crystalline glycine and a 1-molal aqueous solution of glycine. The application of Equation (9.32) leads to the expression

$$dJ = J_{m2(s)}^\bullet dn_{2(s)} + J_{m2(m_2=1)} dn_2 \quad (18.48)$$



As mass is conserved in the transfer,

$$-dn_{2(s)} = dn_{2(m_2=1)} \equiv dn$$

and Equation (18.48) can be written as

$$\begin{aligned} dJ &= -J_{m2(s)}^{\bullet} dn + J_{m2(m_2=1)} dn \\ &= [J_{m2(m_2=1)} - J_{m2(s)}^{\bullet}] dn \end{aligned} \tag{18.49}$$

Equation (18.49) can be integrated to obtain the change in  $J$  for the solution of one mole of glycine in an infinite volume of solution of molality  $m_2$ :

$$\int_{J_1}^{J_2} dJ = \int_{n_2}^{n_2+1} [J_{m2(m_2=1)} - J_{m2(s)}^{\bullet}] dn \tag{18.50}$$

or

$$\Delta J = J_2 - J_1 = \int_{n_2}^{n_2+1} [J_{m2(m_2=1)} - J_{m2(s)}^{\bullet}] dn \tag{18.51}$$

It is characteristic of a differential process that the transfer occurs without a change in the composition of any phase. If a finite change of state is to occur without a change of composition, the aqueous solution of Equation (18.47) must have a volume sufficiently large that the addition of one mole of solid glycine does not change the composition, so that  $J_{m2(m_2=1)}$ , like  $J_{m2(s)}^{\bullet}$ , is a constant. Then the integral on the right side of Equation (18.51) can be evaluated as

$$\Delta J = J_2 - J_1 = J_{m2(m_2=1)} - J_{m2(s)}^{\bullet} \tag{18.52}$$

For the case in which  $J$  represents the volume of the system, we can use the data (Table 18.3) of Gucker et al. [1] on the partial molar volumes in aqueous glycine

**TABLE 18.3. Partial Molar Volumes in Aqueous Solutions of Glycine**

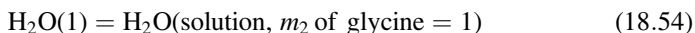
$m/(\text{mol kg}^{-1})$	$V_{m2}/(\text{cm}^3 \text{ mol}^{-1})$	$V_{m1}/(\text{cm}^3 \text{ mol}^{-1})$
0	43.20	18.07
1	44.88	18.05
Pure solid	46.71	

solutions. Then we calculate  $\Delta V$  for the change of state in Equation (18.47) as

$$\begin{aligned}\Delta V &= V_{m2(m2=1)} - V_{m2(s)}^\bullet \\ &= 44.88 \text{ cm}^3 \text{ mol}^{-1} - 46.71 \text{ cm}^3 \text{ mol}^{-1} \\ &= -1.83 \text{ cm}^3 \text{ mol}^{-1}\end{aligned}\quad (18.53)$$

Thus, the volume change for Equation (18.47) is the sum of the volume change for the disappearance of one mole of solid glycine,  $-V_{m2(s)}^\bullet$ , and the volume change for the addition of one mole of solid glycine to a large volume of solution with  $m_2 = 1$ ,  $V_{m2}$ .

A process analogous to that of Equation (18.47) is



for which

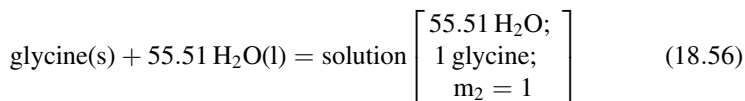
$$\Delta J = J_{m1(m2=1)} - J_{m1}^\bullet$$

or, for the volume,

$$\begin{aligned}\Delta V &= V_{m1(m2=1)} - V_1^\bullet \\ &= 18.05 \text{ cm}^3 \text{ mol}^{-1} - 18.07 \text{ cm}^3 \text{ mol}^{-1} \\ &= -0.02 \text{ cm}^3 \text{ mol}^{-1}\end{aligned}\quad (18.55)$$

### Integral Process

More typical of common experience is a mixing process such as



for which

$$\Delta J = J_{\text{final}} - J_{\text{initial}}$$

But the expression for  $J_{\text{final}}$  and  $J_{\text{initial}}$  includes terms for all components of the initial and final phases, because the composition of the phases changes during the mixing process. Thus,

$$\Delta J = n_1 J_{m1} + n_2 J_{m2} - n_1 J_{m1}^\bullet - n_2 J_{m2(s)}^\bullet \quad (18.57)$$

which for Equation (18.56) becomes

$$\begin{aligned}\Delta J &= 55.51(J_{m1} - J_{m1}^{\bullet}) + J_{m2} - J_{m2(s)}^{\bullet} \\ &= 55.51(-.02) + 44.88 - 46.71 \\ &= -2.94 \text{ cm}^3\end{aligned}\quad (18.58)$$

## 18.5 EXCESS PROPERTIES: VOLUME AND ENTHALPY

### Excess Volume

As with other excess thermodynamic properties (Section 16.7), the excess volume is defined as

$$V_M^E = \Delta V_{\text{mix}} - \Delta V_{\text{mix}}^I = \Delta V_{\text{mix}} \quad (18.59)$$

because  $\Delta V_{\text{mix}}^I$ , the volume change on mixing for an ideal solution, is equal to zero. The values of  $V_M^E$  can be measured directly with a dilatometer, or they can be calculated from density measurements of pure components and solutions. For mixtures of components A and B

$$V_M^E = \frac{[XM_A + (1 - X)M_B]}{\rho} - \frac{XM_A}{\rho_A} - \frac{(1 - X)M_B}{\rho_B} \quad (18.60)$$

where  $M_A$  and  $M_B$  are the molar masses of the components,  $\rho_A$  and  $\rho_B$  are the corresponding densities,  $X$  is the mole fraction of A, and  $\rho$  is the density of the solution. As with the excess Gibbs function, analytical expressions for excess volumes can be obtained by fitting experimental data to a Redlich–Kister expression of the form

$$V_M^E = X(1 - X) \sum_{i=0}^{i=N} A_i(2X - 1)^i \quad (18.61)$$

where  $X$  is the mole fraction of component A and  $N$  is determined by fitting polynomials with successively larger number of terms until an additional term does not improve the sum of squares of deviations between experimental and calculated values, which is a quantity provided by the fitting program (see Section A.1).

### Excess Enthalpy

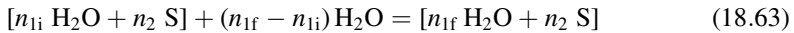
From Equation (16.58),

$$H_M^E = \Delta H_{\text{mix}}$$

so experimental values of enthalpy of mixing give the excess enthalpies directly. As with excess Gibbs function and excess volumes, the results can be fitted to a Redlich–Kister expression of the form

$$H_M^E = X(1 - X) \sum_{i=0}^{i=N} A_i(2X - 1)^i \quad (18.62)$$

Enthalpy of dilution data can be used to calculate excess enthalpies by a procedure analogous to that we used to calculate relative molar enthalpy from enthalpy of dilution. We can describe the dilution of an aqueous solution of  $n_1$  moles of water and  $n_2$  moles of solute S with  $(n_{1f} - n_{1i})$  moles of water by the equation



For this process, the enthalpy of dilution is given by

$$\Delta H_{\text{dil}} = n_{1f}H_{m1f} + n_2H_{m2f} - [n_{1i}H_{m1i} + n_2H_{m2i} + (n_{1f} - n_{1i})H_{m1}^\circ] \quad (18.64)$$

Exercise (18.20) leads to the result

$$\Delta H_{m,\text{dil}} = H_{mf}^E - H_{mi}^E \quad (18.65)$$

For solutions for which the molality is a convenient measure of composition, it has been suggested [6] that  $H_m^E$  can be expressed as a polynomial in  $m$

$$H_m^E = h_1m + h_2m^2 + \dots \quad (18.66)$$

Consequently,

$$\Delta H_{m,\text{dil}} = h_1(m_f - m_i) + h_2(m_f - m_i)^2 + \dots \quad (18.67)$$

The constants needed to obtain a value of  $H_m^E$  as a function of  $m$  can be obtained by fitting the enthalpy of dilution data to Equation (18.67) by a nonlinear least-squares method. (see Section A.1).

## EXERCISES

**18.1.** Show that  $\partial J/\partial X_1$  is not identical with  $\partial J/\partial n_1$  if  $n_2$  is held constant in both cases.

**18.2. a.** If  $V$  is the volume of a two-component solution containing 1 kg of solvent, show that

$$V_{m2} = \frac{M_2 - V(\partial\rho/\partial m_2)_{T,P}}{\rho}$$

in which  $M_2$  is the molar mass of the solute,  $\rho$  is the density of the solution, and  $m_2$  is the molality of solute.

b. Show that

$$V_{m1} = \frac{M_1 \left[ 1 + m_2 V \left( \frac{\partial \rho}{\partial m_2} \right)_{T,P} \right]}{\rho}$$

18.3. If  $c$  is the concentration in moles of solute per  $\text{dm}^3$  of solution,  $\rho$  is the density of the solution, and  $\rho_0$  is the density of pure solvent, show that

a. 
$$\phi V_2 = \frac{1}{c} - \frac{1}{\rho_0} \left[ \frac{\rho}{c} - M_2 \right]$$

b. 
$$V_{m2} = \frac{M_2 - (\partial \rho / \partial c)_{T,P}}{\rho - c(\partial \rho / \partial c)_{T,P}}$$

c. 
$$V_{m1} = \frac{M_1}{\rho - c(\partial \rho / \partial c)_{T,P}}$$

d. For a particular two-component solution, the density can be expressed as a linear function of the molar concentration of the solute. Prove that  $V_{m1} = V_{m1}^\bullet$  and  $V_{m2} = \text{constant}$ .

18.4. a. Verify the calculations in Table 18.1 for the solutions that are 20 and 25 mass percent ethanol.

b. Plot the volume per mole of water (Column 5) versus  $n_2/n_1$ .

c. Fit the data used to plot the graph in (b) to an appropriate polynomial in  $n_2/n_1$ .

d. Plot the volume per mole of ethanol (Column 7) against  $n_1/n_2$ .

e. Fit the data used to plot the graph in (d) to an appropriate polynomial in  $n_1/n_2$ .

f. As a method of checking the calculations in Table 18.1, calculate the volume of 500 g of a 45% ethanol solution from the partial molar volumes, and compare the value obtained with that which can be calculated directly by using the density.

g. Carry out a numeric integration of  $V_{m1}$  as a function of  $n_1/n_2$  to find the difference between  $V_{m2}$  in a 65% solution and  $V_{m2}$  in a 25% solution.

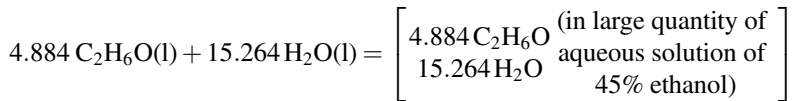
h. Find  $V_{m2}$  for a 25% solution from the fitted polynomial in (e), and add it to the difference calculated in (g). Compare the sum with the value of  $V_{m2}$  in a 65% solution, which can be found from the fitted polynomial in (e).

- 18.5.** Using the data in Exercise 4 and the data for the density of pure  $\text{H}_2\text{O}$  ( $0.99708 \text{ g cm}^{-3}$  at  $25^\circ\text{C}$ ) and of pure ethanol ( $0.78506 \text{ g cm}^{-3}$  at  $25^\circ\text{C}$ ), compute the volume changes per mole of ethanol for the following processes:
- $\text{C}_2\text{H}_6\text{O(l)} = \text{C}_2\text{H}_6\text{O}$  (45% aqueous ethanol)
  - $\text{H}_2\text{O(l)} = \text{H}_2\text{O}$  (45% aqueous ethanol)
- 18.6.** Compute  $V_m = V/(n_1 + n_2)$  for each of the ethanol–water mixtures in Table 18.1, and plot the value of  $V_m$  as a function of  $X_{\text{H}_2\text{O}}$ . It can be shown that the equation of the tangent line to the curve that you have drawn is

$$V_m = (V_{m1} - V_{m2})X_1 + V_{m2}$$

Fit the data for  $V_m$  as a function of  $X_1$  to this equation, and use this equation to calculate the values of  $V_{m1}$  and  $V_{m2}$  in a 45% ethanol solution. Compare them with the results in Exercise 4 (**g** and **h**).

- 18.7. a.** Compute the volume change for the process



- Compute the volume change for the process  $4.884 \text{ C}_2\text{H}_6\text{O(l)} + 15.264 \text{ H}_2\text{O(l)} = 500 \text{ g}$  of aqueous solution of 45% ethanol
  - Compare the answers in (**a**) and (**b**). They should be the same, within computational error. Why?
  - Write word statements that emphasize the differences in meaning among the equations in Exercises 5(**a**), 5(**b**), 7(**a**), and 7(**b**).
- 18.8.** The specific heats of aqueous solutions of glycolamide at  $25^\circ\text{C}$  are listed in Table 18.4. [Reprinted with permission from Ref. 1. Copyright 1941 American Chemical Society.]
- Using the method of least squares, derive a polynomial expression for  $C_{Pm}$  as a function of  $m_2$ .
  - Derive an equation for the partial molar heat capacity of glycolamide based on the least-squares equation for  $C_{Pm}$ .
  - Calculate numeric values of  $C_{Pm(2)}$  at the concentrations listed in Table 18.4, and plot them as a function of  $m_2$ .
  - Derive an equation for the partial molar heat capacity of water in aqueous solutions of glycolamide, and plot calculated values as a function of  $m_2$ .

**TABLE 18.4. Specific Heats of Glycolamide (aq) at 25°C**

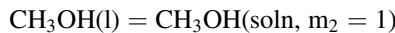
$m_2/(\text{mol kg}^{-1})$	$C_{Pm}/(\text{cal g}^{-1}) \text{ mol}^{-1}$
0.0000	(1.00000)
0.2014	0.99223
0.4107	0.98444
0.7905	0.97109
1.2890	0.95467
1.7632	0.94048
2.6537	0.91666
4.3696	0.87899
4.3697	0.87900
6.1124	0.84891

- 18.9.** According to MacInnes and Dayhoff [7], the apparent molar volume of KI in  $\text{CH}_3\text{OH}$  can be expressed by the equation

$$\phi V_2 = 21.45 + 11.5 m_2^{1/2}$$

when  $V$  is expressed in  $\text{cm}^3$ . The density of pure methanol is  $0.7865 \text{ g cm}^{-3}$ .

- Derive the corresponding expression for the volume as a function of molality for a solution that contains 1 kg of solvent.
- Compute  $\Delta V_m$  for the process



- 18.10.** For iodine in methanol solution, the partial molar volume of the solute is essentially constant, independent of concentration, and is equal to  $62.3 \text{ cm}^3 \text{ mol}^{-1}$  at  $25^\circ\text{C}$  [7]. Solid  $\text{I}_2$  has a density of  $4.93 \text{ g cm}^{-3}$ , and pure methanol has a density of  $0.7865 \text{ g cm}^{-3}$  at  $25^\circ\text{C}$ .
- Compute  $\Delta V_m$  for  $\text{I}_2(s) = \text{I}_2(m_2 = 1)$ .
  - Compute  $\Delta V_m$  for  $\text{I}_2(s) = \text{I}_2(m_2 = 0)$ .
  - Compute  $\Delta V_m$  for  $\text{I}_2(m_2 = 1) = \text{I}_2(m_2 = 0)$ .
  - Compute  $\Delta V_m$  for  $\text{CH}_3\text{OH}(l) = \text{CH}_3\text{OH}(\text{soln}, m_2 = 1)$ .
  - Compute  $\Delta V_m$  for  $\text{I}_2(s) + 31.2 \text{ CH}_3\text{OH}(l) = \text{soln}(m_2 = 1)$ .

- 18.11.** Gucker et al. [8] have found that the equation

$$\Phi L_2 = 128.9 m_2$$

expresses the relative apparent molar enthalpy of aqueous solutions of sucrose at  $20^\circ\text{C}$  when  $\Phi L_2$  is in  $\text{cal mol}^{-1}$ . Derive expressions for  $L$ , the relative molar enthalpy per kilogram of solvent,  $L_{m2}$ , and  $L_{m1}$  as a function of the molality.

- 18.12.** Prove that  $\partial L_{m1}/\partial T = C_{Pm(1)} - C_{Pm(1)}^\bullet$ .

- 18.13.** With the aid of the data in Exercise 11 and the following equation for the relative molar enthalpy per kilogram of solvent at 30°C (in units of cal mol<sup>-1</sup>),

$$L = 140.2m_2^2$$

derive expressions for  $C_{Pm(2)}$  and  $C_{Pm(1)}$  for aqueous sucrose solutions at 25°C.  $C_{pm(2)}^\circ$  is 151.50 cal mol<sup>-1</sup> K<sup>-1</sup>. What assumption must be made to do the calculation with these data alone?

- 18.14.** The heat absorbed when  $m_2$  moles of NaCl is dissolved in 1000 g of H<sub>2</sub>O is given by the expression (for  $\Delta H$  in cal kg<sup>-1</sup> of water).

$$\begin{aligned} \Delta H = & (923 \text{ cal mol}^{-1}) m_2 + (476.1 \text{ cal mol}^{-1.5} \text{ kg}^{0.5}) m_2^{3/2} \\ & - (726.1 \text{ cal mol}^{-2} \text{ kg}) m_2^2 + (243.5 \text{ cal mol}^{-2.5} \text{ kg}^{1.5}) m_2^{5/2} \end{aligned}$$

- Derive an expression for  $L_{m2}$ , and compute values of the relative partial molar enthalpy of NaCl in 0.01 molal and 0.1 molal solutions.
- Derive an expression for  $L_{m1}$ , and compute its value for 0.01 molal and 0.1 molal solutions.
- If the expression in this exercise for  $\Delta H$  per 1000 g of H<sub>2</sub>O is divided by  $m_2$ , the number of moles of solute in 1000 g of H<sub>2</sub>O, we obtain the heat absorbed when one mole of NaCl is dissolved in enough water to give a molality equal to  $m_2$ . Show that this equation is

$$\begin{aligned} \Delta H_m \text{ (for 1 mole of NaCl)} = & 923 + 476.1 m_2^{1/2} - 726.1 m_2 \\ & + 243.5 m_2^{3/2} \end{aligned}$$

- Calculate  $(\partial\Delta H/\partial n_1)_{n_2}$  from the preceding expression. Derive an equation for  $L_{m1}$ , and compare the result with that obtained in (b).

- 18.15.** Table 18.5 lists the relative partial molar enthalpies of glycine and its aqueous solutions at 25°C. [Reprinted with permission from Ref. 9. Copyright 1940 American Chemical Society.]

- The enthalpy of solution of an infinitesimal quantity of pure solid glycine in a saturated aqueous solution is 3411 cal mol<sup>-1</sup>. Show that  $L_{m2(s)}^\circ$  is -3765 cal mol<sup>-1</sup>.
- Calculate  $\Delta H_m$  for the addition of an infinitesimal quantity of solid glycine to a 1-molal aqueous solution.
- Calculate  $\Delta H_m$  for the addition of an infinitesimal quantity of solid glycine to an infinitely dilute aqueous solution.
- Calculate  $\Delta H_m$  for the addition of one mole of solid glycine to 1000 g of pure water to form a 1-molal aqueous solution.



**TABLE 18.5. Relative Molar Enthalpies of Glycine (s) and Glycine (aq) at 25°C**

$m_2/(\text{mol kg}^{-1})$	$L_{m1}/(\text{cal mol}^{-1})$	$L_{m2}/(\text{cal mol}^{-1})$
1.000	1.537	-165.5
3.33 (saturated)		-354
Glycine (pure)		-3765

- 18.16.** At 25°C the partial molar volume of urea  $[\text{CO}(\text{NH}_2)_2]$  solution in water is found by a nonlinear least-squares fitting procedure to be the following function of  $m_2$  up to 17-molal concentration (with  $V$  in  $\text{cm}^3 \text{mol}^{-1}$ ), with experimental data from Gucker et al. [10] and the form of the equation from Stokes:

$$V = 1002.894 + 44.3838 \frac{m_2}{(1 - 0.007413 m_2)} - 0.24613 \frac{m_2^2}{(1 - 0.007413 m_2)^2} + 1.034 \times 10^{-8} \frac{m_2^3}{(1 - 0.007413 m_2)^3}$$

Table 18.6 show the experimental results of Gucker et al. [10] for the molar concentration of urea, the density  $\rho$  of the solutions in grams per liter, and the partial molar volume of urea in  $\text{cm}^3$  calculated from the density data.

**TABLE 18.6. Density Data from Ref. 10 for Aqueous Solutions of Urea**

$C/\text{mol L}^{-1}$	$\rho/\text{g L}^{-1}$	$V_{m2}/\text{cm}^3 \text{mol}^{-1}$
0.00000	997.074	(44.218)
0.11394	998.892	44.250
0.15077	999.475	44.260
0.35215	1002.683	44.320
0.41500	1003.675	44.340
0.62386	1006.983	44.380
1.00812	1013.039	44.486
1.36866	1018.669	44.576
1.88532	1026.698	44.698
2.42107	1034.410	44.817
3.33355	1048.838	45.004
3.98193	1058.612	45.123
5.05362	1074.560	45.302
5.92297	1087.289	45.428
7.28543	1106.989	45.597
8.20690	1120.039	45.690
9.52555	1138.980	45.801
9.53161	1138.910	45.802

- a. Calculate the corresponding values of  $m_2$  at each concentration.
- b. Plot  $V_{m2}$  as a function of  $m_2$ , and compare the experimental values with a curve for a cubic polynomial fit and the curve for the nonlinear equation above.
- c. Calculate the residuals for both the cubic fit and the nonlinear equation, and plot them. Explain on the basis of the residuals why the nonlinear equation is a better fit even at low molalities.
- d. Calculate  $V$  for 1 kg of solvent and  $V_{m1}$  for each solution from values of  $m_2$  and the density.
- e. The density of solid urea is  $1.335 \text{ g cm}^{-3}$  and the density of pure liquid water is  $0.988 \text{ g cm}^{-3}$ . Calculate  $\Delta V_m$  for each of the following processes:
- (i)  $\text{urea(s)} = \text{urea(aq soln, } m_2 = 1.4615)$
- (ii)  $\text{urea(s)} + 55.51 \text{ H}_2\text{O(l)} = \text{solution}(m_2 = 1.4615)$
- 18.17.** Calado and Gomes de Azevedo (11) have measured the molar volume of liquid mixtures of ethane and ethene at 161.39 K. Their values are shown in Table 18.7.
- a. Calculate the partial molar volumes of each component at the given mole fractions.
- b. Derive the relation between the partial molar volumes and the excess volumes in the third column.
- 18.18.** Mato et al. [12] measured the excess volume of solutions of methyl *tert*-butyl ether [1] and chloroform [2] at 298.15 K. Their data are shown in Table 18.8.
- a. Plot  $V_m^E$  as a function of  $X_1$ , and fit the data to an equation of the form

$$V_m^E = X_1 X_2 [A + B(2X_1 - 1) + C(2X_1 - 1)^2] \quad (18.68)$$

- b. Plot the fitted curve on the same graph.

**TABLE 18.7. Molar Volume of Liquid Mixtures of Ethane and Ethene at 161.39 K**

$X(\text{ethene})$	$V_m/\text{cm}^3 \text{ mol}^{-1}$	$V_m^E/\text{cm}^3 \text{ mol}^{-1}$
0.0000	52.548	0.000
0.2444	51.684	0.131
0.3253	51.365	0.141
0.4214	50.988	0.156
0.5357	50.519	0.153
0.6407	50.086	0.148
0.7115	49.793	0.142
0.7898	49.445	0.114
1.0000	48.475	0.000

**TABLE 18.8. Excess Volumes of Solutions of Methyl *tert*-Butyl Ether and Chloroform at 198.15 K**

$X_1$	$V_m^E$
0.0703	-0.416
0.1525	-0.718
0.2167	-0.774
0.2927	-0.958
0.377	-1.004
0.476	-1.051
0.5782	-1.006
0.6053	-0.986
0.6576	-0.954
0.7776	-0.734
0.7895	-0.735
0.8209	-0.585
0.8637	-0.477
0.8681	-0.427
0.9439	-0.230

**18.19.** Palmer and Smith [13] have measured the equilibrium pressure  $P$ , liquid composition  $X_1$ , vapor composition  $Y_1$ , and excess enthalpy for solutions of acetonitrile [1] and benzene [2] at 45°C. The data are shown in Table 18.9.

- Calculate the partial pressure of each component, the activity of each component in the liquid phase based on a Raoult's-law standard state, and the excess Gibbs function of each solution shown in the first three columns. Plot the values of  $\ln(\gamma_1/\gamma_2)$  against  $X_1$  to determine the kind of Redlich–Kister polynomial to use for fitting the data. As that plot is nonlinear, at least a two-parameter polynomial is needed. Fit your data to a four-parameter polynomial, and compare graphically the calculated function and the calculated values of  $G_M^E$  from the vapor pressure data.
- Plot the values of  $H_M^E/(\text{J mol}^{-1})$  against  $X_1$  from the data in the table. Fit these data with an analogous four-parameter function, and plot the calculated function on the same graph.
- Use the functions you obtained for  $G_M^E$  and  $H_M^E$  to calculate  $S_M^E$  as a function of  $X_1$ . Plot the values of  $G_M^E$ ,  $H_M^E$ , and  $TS_M^E$  on the same graph. Comment on the basis for the sign of  $TS_M^E$ .

**18.20.** Show that the molar enthalpy of dilution  $\Delta H_{\text{dil}}/n_2$  is equal to  $H_{\text{mf}}^E - H_{\text{mi}}^E$ .

**18.21.** Reading and Hedwig [14] measured the enthalpy of dilution of aqueous solutions of some dipeptides at 298.15 K. Their data for glycyl-*L*-valine are given in Table 18.10. Fit the data to Equation (18.67), starting with a first-power polynomial and adding terms until the sum of square deviations no longer decreases, and use the constant(s) you obtain to express  $H_m^E$  as a function of  $m$ . Plot the values calculated from the fitted function.

**TABLE 18.9. Vapor and Liquid Compositions, Equilibrium Pressures, and Excess Enthalpies for Solutions of Acetonitrile and Benzene at 45°C**

$X_1$	$Y_1$	$P/(\text{atm})$	$X_1$	$H_M^E/(\text{cal})$	$H_M^E/J$
0.0000	0.0000	0.2939	0.0000	0.0	0.0
0.0247	0.0682	0.3084	0.0848	33.0	138.1
0.0744	0.1531	0.3270	0.1778	59.7	249.8
0.2221	0.3018	0.3534	0.2537	78.1	326.8
0.3091	0.3670	0.3618	0.3309	94.0	393.3
0.4145	0.4361	0.3663	0.4048	105.8	442.7
0.5266	0.4962	0.3667	0.4812	114.1	477.4
0.5680	0.5146	0.3653	0.5403	117.4	491.2
0.6858	0.5987	0.3568	0.5708	117.9	493.3
0.7953	0.6759	0.3433	0.6025	117.5	491.6
0.8912	0.7749	0.3222	0.6431	114.4	478.6
0.9833	0.9516	0.2847	0.6460	115.2	482.0
1.0000	1.0000	0.2749	0.6805	111.3	465.7
			0.7408	102.9	430.5
			0.8016	89.1	372.8
			0.8669	67.8	283.7
			0.9361	36.6	153.1
			1.0000	0.0	0.0

**TABLE 18.10. Enthalpies of Dilution and Initial and Final Molalities for Aqueous Solutions of Glycyl-L-Valine at 298.15 K**

$m_i$	$m_f$	$\Delta H_{m,dil}$
0.3001	0.1478	-123.3
0.3001	0.0981	-168.2
0.2798	0.1380	-116.5
0.2798	0.0916	-157.9
0.2598	0.1283	-106.1
0.2390	0.1182	-98.7
0.2390	0.0785	-133.4
0.2199	0.1087	-92.2
0.2199	0.0723	-124.7
0.2002	0.0992	-85.2
0.2002	0.0659	-112.5
0.1798	0.0892	-75.6
0.1798	0.0593	-99.1
0.1596	0.0793	-65.8
0.1596	0.0527	-86.4
0.1399	0.0696	-58.1
0.1399	0.0463	-74.3
0.1199	0.0597	-50.0
0.1199	0.0397	-67.6
0.1000	0.0499	-44.2
0.1000	0.0322	-56.8

**TABLE 18.11. Enthalpies of Solutions of Pure Solids and Solid Solutions of Iron and Magnesium Silicates**

$X_1$	$\Delta H_{\text{solution}}/(\text{kJ mol}^{-1})$
$\text{Fe}_2 \text{SiO}_4$	$19.52 \pm 0.86$
$(\text{Mg}_{0.2}, \text{Fe}_{0.8})_2 \text{SiO}_4$	$28.06 \pm 1.83$
$(\text{Mg}_{0.4}, \text{Fe}_{0.6})_2 \text{SiO}_4$	$37.31 \pm 1.72$
$(\text{Mg}_{0.6}, \text{Fe}_{0.4})_2 \text{SiO}_4$	$47.82 \pm 1.13$
$(\text{Mg}_{0.8}, \text{Fe}_{0.2})_2 \text{SiO}_4$	$58.33 \pm 1.51$
$\text{Mg}_2 \text{SiO}_4$	$70.51 \pm 0.62$

**18.22.** Kojitani and Akaogi [15] calculated the excess enthalpy of mixing of solid  $\text{Fe}_2\text{SiO}_4$  and  $\text{Mg}_2\text{SiO}_4$  to form olivine solid solutions at 979 K from measurements of the enthalpy of solution of the pure solids to form solid solutions of known composition in molten  $2\text{PbO} \cdot \text{B}_2\text{O}_3$  at the same temperature. Their data are given in Table 18.11. The column labeled  $X_1$  shows the composition of the solid solutions, and  $X_1$  represents the mole fraction of  $\text{Mg}_2\text{SiO}_4$  in each sample.

- Calculate the values of  $H_m^E$  for each solid solution.
- Fit the data to a Redlich–Kister polynomial for a regular solution.
- Plot the experimental points and the calculated equation on the same graph.

## REFERENCES

- F. T. Gucker, W. L. Ford, and C. E. Moser, *J. Phys. Chem.* **43**, 153, 309 (1939); **45**, 309 (1941). Reprinted by permission. Copyright 1941 American Chemical Society.
- I. M. Klotz and R. M. Rosenberg, *Chemical Thermodynamics*, 5th ed., John Wiley and Sons, New York, 1994, pp. 369–370; L. F. Loucks, *J. Chem. Educ.* **76**, 425 (1999).
- G. N. Lewis and M. Randall, *Thermodynamics*, McGraw-Hill, New York, 1923, p. 96.
- R. S. Humphrey, G. R. Hedwig, I. D. Watson, and G. N. Malcolm, *J. Chem. Thermodynamics* **12**, 595 (1980).
- Z. Yan, J. Wang, H. Zhang, and X. Xuan, *J. Chem. Eng. Data* **50**, p. 1864–1870 (2005).
- J. E. Desnoyers, G. Perron, L. Avédikan, and J.-P. Morel, *J. Solution Chem.* **5**, 631 (1976).
- D. A. MacInnes and M. O. Dayhoff, *J. Am. Chem. Soc.* **75**, 5219 (1953).
- F. T. Gucker, Jr., H. B. Pickard, and R. W. Planck, *J. Am. Chem. Soc.* **61**, 459 (1939).
- F. T. Gucker, Jr., H. B. Pickard, and W. L. Ford, *J. Am. Chem. Soc.* **62**, 2698 (1940).
- F. T. Gucker, Jr., F. W. Gage, and C. E. Moser, *J. Am. Chem. Soc.* **60**, 2582 (1938); R. H. Stokes, *Austral. J. Chem.* **20**, 2087 (1967).
- J. C. G. Calado and E. J. S. Gomes de Azevedo, *J. Chem. Soc., Faraday Trans. 1* **79**, 2657 (1983).

12. F. A. Mato, C. Berro, and A. Péneloux, *J. Chem. Eng. Data* **36**, 259 (1991).
13. D. A. Palmer and B. F. Smith, *J. Chem. Eng. Data* **17**, 71 (1972).
14. J. R. Reading and G. R. Hedwig, *Thermochimica Acta* **242**, 41 (1994).
15. H. Kojitani and M. Akaogi, *Phys. Chem. Miner.* **20**, 536 (1994).



## CHAPTER 19

---

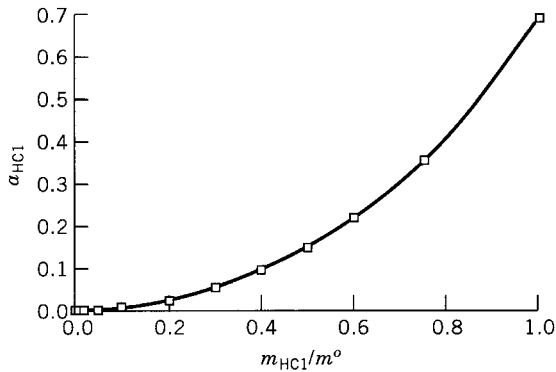
# ACTIVITY, ACTIVITY COEFFICIENTS, AND OSMOTIC COEFFICIENTS OF STRONG ELECTROLYTES

---

In Chapters 16 and 17, we developed procedures for defining standard states for nonelectrolyte solutes and for determining the numeric values of the corresponding activities and activity coefficients from experimental measurements. The activity of the solute is defined by Equation (16.1) and by either Equation (16.3) or Equation (16.4) for the hypothetical unit mole fraction standard state ( $X_2^\circ = 1$ ) or the hypothetical 1-molal standard state ( $m_2^\circ = 1$ ), respectively. The activity of the solute is obtained from the activity of the solvent by use of the Gibbs–Duhem equation, as in Section 17.5. When the solute activity is plotted against the appropriate composition variable, the portion of the resulting curve in the dilute region in which the solute follows Henry’s law is extrapolated to  $X_2 = 1$  or  $(m_2/m^\circ) = 1$  to find the standard state.

When activity data for a strong electrolyte such as HCl are plotted against  $(m_2/m^\circ)$ , as illustrated in Figure 19.1, the initial slope is equal to zero. Thus, an extrapolation to the standard state yields a value of the activity in the standard state equal to zero, which is contrary to the definition of activity in Equations (16.1) and (16.3). Therefore, it is clear that the procedure for determining standard states must be modified for electrolytes.





**Figure 19.1.** Activity as a function of molality ratio for aqueous HCl. Based on data from Ref. 1, p. 336.

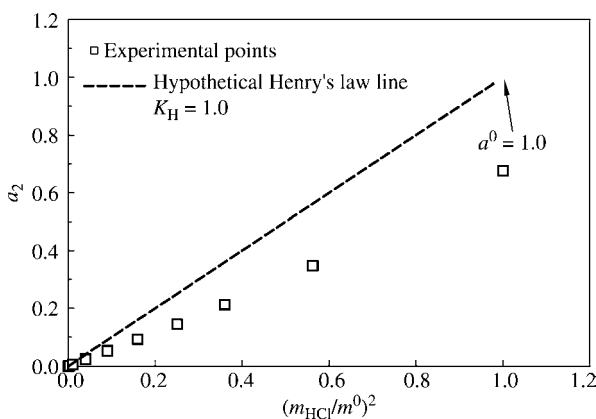
## 19.1 DEFINITIONS AND STANDARD STATES FOR DISSOLVED ELECTROLYTES

### Uni-univalent Electrolytes

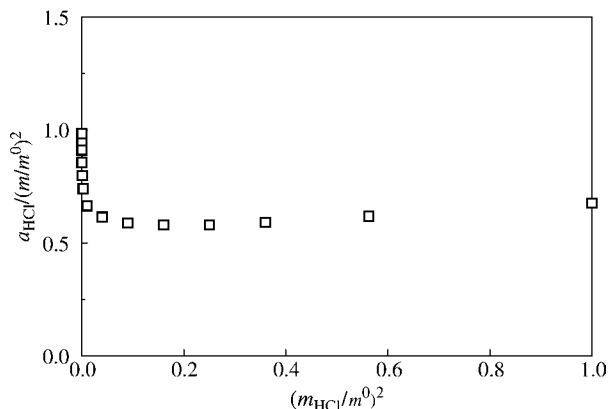
As a plot of the activity of an electrolyte such as aqueous HCl against the first power of  $m_2/m^{\circ}$  gives a limiting slope of zero, we might examine graphs in which the activity is plotted against other powers of the molality ratio. Such a plot is shown in Figure 19.2, in which the activity of aqueous HCl is plotted against the square of the molality ratio. The curve has a finite, nonzero limiting slope.

This result suggests that the appropriate form of the limiting law for uni-univalent electrolytes (such as HCl) is

$$\lim_{m_{\text{HCl}} \rightarrow 0} \frac{a_{\text{HCl}}}{(m_{\text{HCl}}/m^{\circ})^2} = 1 \quad (19.1)$$



**Figure 19.2.** Activity as a function of the square of the molality ratio for aqueous HCl. The data are the same as for Figure 19.1.



**Figure 19.3.** A plot of the ratio of activity to the molality ratio to test for the validity of Henry's law.

which is a modified form of Henry's law. To test for agreement with this form of Henry's law, we plot the ratio  $a/(m/m^\circ)^2$  against  $(m/m^\circ)^2$ , as in Figure 19.3.

If followed in experimentally accessible dilute solutions, Henry's law would be manifested as a horizontal asymptote in a plot such as Figure 19.3 as the square of the molality ratio goes to zero. We do not observe such an asymptote. Thus, the modified form of Henry's law is not followed over the concentration range that has been examined. However, the ratio of activity to the square of the molality ratio does extrapolate to 1, so that the data does satisfy the definition of activity [Equations (16.1) and (16.2)]. Thus, the activity clearly becomes equal to the square of the molality ratio in the limit of infinite dilution. Henry's law is a limiting law, which is valid precisely at infinite dilution, as expressed in Equation (16.19). No reliable extrapolation of the curve in Figure 19.2 exists to a hypothetical unit molality ratio standard state, but as we have a finite limiting slope at  $m_2/m_2^\circ = 0$ , we can use that slope to guide us to the standard state; the appropriately modified Henry's law line is shown in Figure 19.2. No real state of the system corresponds to the standard state, but the properties of the standard state can be calculated from the Henry's-law constant.

Thus far, we have not introduced any assumptions about the dissociation of electrolytes in order to describe their experimental behavior. As far as thermodynamics is concerned, such details need not be considered. We can take the limiting law in the form of Equation (19.1) as an experimental fact and derive thermodynamic relationships from it. Nevertheless, in view of the general applicability of the ionic theory, it is desirable to relate our results to that theory.

For example, the empirical relation between the activity and the molality ratio can be understood on the assumption that the chemical potential of the electrolyte is the sum of the chemical potentials of the constituent ions. That is, for HCl as the solute,

$$\mu_{\text{HCl}} = \mu_{\text{H}^+} + \mu_{\text{Cl}^-} \quad (19.2)$$

If we apply Equation (16.1), which is the definition of the activity, to Equation (19.2), the result is

$$\mu_{\text{HCl}}^{\circ} + RT \ln a_{\text{HCl}} = \mu_{\text{H}^+}^{\circ} + RT \ln a_{\text{H}^+} + \mu_{\text{Cl}^-}^{\circ} + RT \ln a_{\text{Cl}^-} \quad (19.3)$$

We can also assume that

$$\mu_{\text{HCl}}^{\circ} = \mu_{\text{H}^+}^{\circ} + \mu_{\text{Cl}^-}^{\circ} \quad (19.4)$$

so that

$$a_{\text{HCl}} = (a_{\text{H}^+})(a_{\text{Cl}^-}) \quad (19.5)$$

The individual ion activities should follow the limiting relations

$$\lim_{m_{\text{HCl}} \rightarrow 0} \frac{a_{\text{H}^+}}{m_{\text{H}^+}/m^{\circ}} = 1 \quad (19.6)$$

and

$$\lim_{m_{\text{HCl}} \rightarrow 0} \frac{a_{\text{Cl}^-}}{m_{\text{Cl}^-}/m^{\circ}} = 1 \quad (19.7)$$

so the product of the limits is

$$\lim_{m_{\text{HCl}} \rightarrow 0} \frac{(a_{\text{H}^+})(a_{\text{Cl}^-})}{(m_{\text{H}^+}/m^{\circ})(m_{\text{Cl}^-}/m^{\circ})} = \lim_{m_{\text{HCl}} \rightarrow 0} \frac{a_{\text{HCl}}}{(m_{\text{HCl}}/m^{\circ})^2} = 1$$

which is the relation found empirically.

No way exists within thermodynamics to determine the activity of a single ion because we cannot vary the concentration of a single ion while keeping the amounts of the other ions constant, because electroneutrality is required. As  $a_+$  and  $a_-$  approach  $m_2$  at infinite dilution for a uni-univalent electrolyte,  $a_+$  must equal  $a_-$  at infinite dilution. However, at any nonzero concentration, the difference between  $a_+$  and  $a_-$  is unknown, although it may be negligibly small in dilute solution. Nevertheless, in a solution of any concentration, the *mean* activity of the ions can be determined. By the mean activity  $a_{\pm}$ , we refer to the geometric mean, which for a uni-univalent electrolyte is defined by the equation

$$a_{\pm} = (a_+ a_-)^{1/2} = a_2^{1/2} \quad (19.8)$$

We can also define an *activity coefficient*  $\gamma_i$  for each ion in an electrolyte solution. For each ion of a uni-univalent electrolyte,

$$\gamma_+ = \frac{a_+}{m_+/m^{\circ}}$$

and

$$\gamma_- = \frac{a_-}{m_-/m^\circ} \quad (19.9)$$

These individual-ion activity coefficients have the desired property of approaching 1 at infinite dilution, because each ratio  $a_i/(m_i/m^\circ)$  approaches 1. However, individual-ion activity coefficients, like individual-ion activities, cannot be determined experimentally. Therefore, it is customary to deal with the mean activity coefficient  $\gamma_{\pm}$  and the mean activity  $a_{\pm}$  which for a uni-univalent electrolyte can be related to measurable quantities as follows:

$$\begin{aligned} \gamma_{\pm} &= (\gamma_+ \gamma_-)^{1/2} \\ &= \left[ \left( \frac{a_+}{m_+/m^\circ} \right) \left( \frac{a_-}{m_-/m^\circ} \right) \right]^{1/2} \\ &= \frac{a_{\pm}}{m_2/m^\circ} = \frac{a_2^{1/2}}{m_2/m^\circ} \end{aligned} \quad (19.10)$$

where  $a_{\pm}$  is given by Equation (19.8). From Equations, (19.1), (19.8), and (19.10), we can see that

$$\lim_{m_2 \rightarrow 0} \gamma_{\pm} = 1 \quad (19.11)$$

### Multivalent Electrolytes

**Symmetrical Salts.** For salts in which anions and cations have the same valence, activities and related quantities are defined in exactly the same way as for uni-univalent electrolytes. For example, for  $\text{MgSO}_4$ , a finite limiting slope is obtained when the activity is plotted against the square of the molality ratio. Furthermore,  $m_+$  equals  $m_-$ . Consequently, the treatment of symmetrical salts does not differ from that just described for uni-univalent electrolytes.

**Unsymmetrical Salts.** As an example of unsymmetrical salts, let us consider a salt such as  $\text{BaCl}_2$ , which dissociates into one cation and two anions. By analogy with the case of a uni-univalent electrolyte, we can define the ion activities by the expression

$$\begin{aligned} a_2 &= (a_+)(a_-)(a_-) \\ &= (a_+)(a_-)^2 \end{aligned} \quad (19.12)$$

In this case, the mean ionic activity  $a_{\pm}$  also is the geometric mean of the individual-ion activities:

$$a_{\pm} = [(a_+)(a_-)^2]^{1/3} = a_2^{1/3} \quad (19.13)$$

It is desirable that the individual-ion activities approach the molality ratio of the ions in the limit of infinite dilution. That is,

$$\lim_{m_2 \rightarrow 0} \frac{a_+}{m_+/m^\circ} = \lim_{m_2 \rightarrow 0} \frac{a_+}{m_2/m^\circ} = 1 \quad (19.14)$$

and

$$\lim_{m_2 \rightarrow 0} \frac{a_-}{m_-/m^\circ} = \lim_{m_2 \rightarrow 0} \frac{a_-}{2m_2/m^\circ} = 1$$

It follows from Equations (19.13) and (19.14) that

$$\begin{aligned} \lim_{m_2 \rightarrow 0} a_{\pm} &= \lim_{m_2 \rightarrow 0} [(a_+)(a_-)^2]^{1/3} \\ &= [(m_2/m^\circ)(2m_2/m^\circ)^2]^{1/3} \\ &= 4^{1/3}(m_2/m^\circ) \end{aligned} \quad (19.15)$$

It is also desirable that the mean ionic activity coefficient  $\gamma_{\pm}$  approach unity in the limit of infinite dilution. We can achieve this result if, as in Equation (19.9), we define

$$\gamma_+ = \frac{a_+}{m_+/m^\circ}$$

and

$$\gamma_- = \frac{a_-}{m_-/m^\circ}$$

and

$$\begin{aligned} \gamma_{\pm} &= [(\gamma_+)(\gamma_-)^2]^{1/3} \\ &= \left[ \left( \frac{a_+}{m_+/m^\circ} \right) \left( \frac{a_-}{m_-/m^\circ} \right)^2 \right]^{1/3} \\ &= \left[ \frac{(a_+)(a_-)^2}{(m_2/m^\circ)(2m_2/m^\circ)^2} \right]^{1/3} \\ &= \frac{a_{\pm}}{(4^{1/3})(m_2/m^\circ)} \end{aligned} \quad (19.16)$$

Then, from Equations (19.15) and (19.16),

$$\lim_{m_2 \rightarrow 0} \gamma_{\pm} = 1$$

For a uni-univalent electrolyte [Equation (19.10)]

$$\gamma_{\pm} = \frac{a_{\pm}}{m_{\pm}/m^{\circ}}$$

To achieve a uniform definition of  $\gamma_{\pm}$  for all electrolytes, it is convenient to define a *mean molality*  $m_{\pm}$  (for  $\text{BaCl}_2$ , for example) as

$$\begin{aligned} m_{\pm} &= [(m_{+})(m_{-})^2]^{1/3} \\ &= [(m_2)(2m_2)^2]^{1/3} \\ &= 4^{1/3}m_2 \end{aligned} \quad (19.17)$$

With this definition, the relationship for the mean activity coefficient

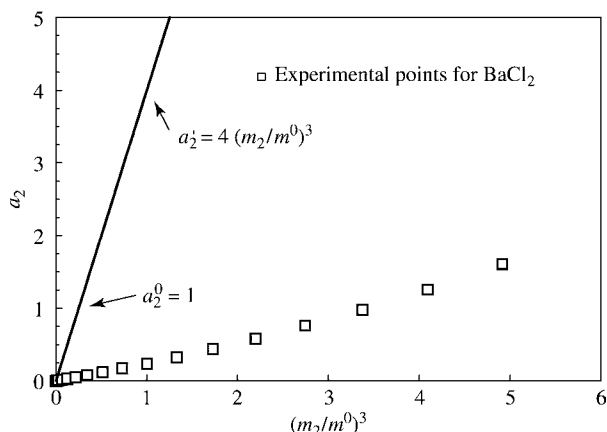
$$\gamma_{\pm} = \frac{a_{\pm}}{m_{\pm}/m^{\circ}} \quad (19.18)$$

holds for any electrolyte.

It follows from Equation (19.13) and Equation (19.15) that

$$\lim_{m_2 \rightarrow 0} \frac{a_2}{(4m_2/m^{\circ})^3} = 1 \quad (19.19)$$

Equation (19.19) is consistent with the empirical observation that a nonzero initial slope is obtained when the activity of a ternary electrolyte such as  $\text{BaCl}_2$  is plotted against the cube of  $(m_2/m^{\circ})$ . As the activity in the standard state is equal to 1, by definition, the standard state of a ternary electrolyte is that hypothetical state of unit molality ratio with an activity one-fourth of the activity obtained by extrapolation of dilute solution behavior to  $m_2/m^{\circ}$  equal to 1, as shown in Figure 19.4.



**Figure 19.4.** Establishment of the standard state for a ternary electrolyte. Data from R. N. Goldberg and R. L. Nuttal, *J. Phys. Chem. Ref. Data* 7, 263 (1978).

**General Case.** If an electrolyte  $A_{v_+}B_{v_-}$  dissociates into  $v_+$  positive ions of charge  $Z_+$  and  $v_-$  negative ions of charge  $Z_-$  the general definitions for the activities and the activity coefficients are

$$a_2 = (a_+)^{v_+}(a_-)^{v_-} \quad (19.20)$$

$$\begin{aligned} a_{\pm} &= (a_2)^{1/(v_++v_-)} = (a_2)^{1/v} \\ &= [(a_+)^{v_+}(a_-)^{v_-}]^{1/v} \end{aligned} \quad (19.21)$$

and

$$\begin{aligned} m_{\pm} &= [(m_+)^{v_+}(m_-)^{v_-}]^{1/v} \\ &= [v_+m_2]^{v_+}(v_-m_2)^{v_-}]^{1/v} \end{aligned} \quad (19.22)$$

The appropriate limiting law that is consistent with experimental observation is

$$\lim_{m_2 \rightarrow 0} \frac{a_2}{(m_2/m^\circ)^v} = (v_+)^{v_+}(v_-)^{v_-} \quad (19.23)$$

and, as before,

$$\gamma_{\pm} = \frac{a_{\pm}}{m_{\pm}/m^\circ} \quad (19.24)$$

Table 19.1 summarizes the empirical expression of the limiting law and the definitions of the ionic activities, molality ratios, and activity coefficients for a few substances and for the general case of any electrolyte.

### Mixed Electrolytes

In a solution of mixed electrolytes, the presence of common ions must be considered when calculating the mean molality. For example, in a solution in which  $m_{\text{NaCl}} = 0.1$  and  $m_{\text{MgCl}_2} = 0.2$ , the mean molality  $m_{\pm}$ , for NaCl is

$$\begin{aligned} m_{\pm \text{NaCl}} &= [(m_{\text{Na}^+})(m_{\text{Cl}^-})]^{1/2} \\ &= [(0.1)(0.5)]^{1/2} \\ &= 0.244 \text{ mol kg}^{-1} \end{aligned}$$

and for  $\text{MgCl}_2$

$$\begin{aligned} m_{\pm \text{MgCl}_2} &= [(m_{\text{Mg}^{2+}})(m_{\text{Cl}^-})^2]^{1/3} \\ &= [(0.2)(0.5)^2]^{1/3} \\ &= 0.368 \text{ mol kg}^{-1} \end{aligned}$$

**TABLE 19.1. Thermodynamic Functions for Dissolved Solutes**

	Sucrose	NaCl	Na <sub>2</sub> SO <sub>4</sub>	AlCl <sub>3</sub>	MgSO <sub>4</sub>	A <sub>v+</sub> B <sub>v-</sub>
$\lim_{m_2 \rightarrow 0} \frac{a_2}{m_2/m^\circ}$	1	1	4	27	1	$v_+^+ v_-^-$
$a_2$	$a_{\text{sucrose}}$	$(a_+)(a_-)$	$(a_+)(a_-)^2$	$(a_+)(a_-)^3$	$(a_+)(a_-)$	$(a_+)^{v_+}(a_-)^{v_-}$
$m_{\pm}$	$[(a_+)(a_-)]^{1/2}$	$[(a_+)(a_-)]^{1/2}$	$[(a_+)^2(a_-)]^{1/3}$	$[(a_+)(a_-)^3]^{1/4}$	$[(a_+)(a_-)]^{1/2}$	$(a_+)^{v_+}(a_-)^{v_-}$
$\gamma_{\pm}$	$m_2$	$m_2$	$4^{1/3} m_2$	$27^{1/4} m_2$	$m_2$	$[(V_+)^{v_+}(V_-)^{v_-}]^{1/v} m_2$
	$\frac{a_{\pm}}{m_{\pm}/m^\circ}$	$\frac{a_{\pm}}{m_{\pm}/m^\circ}$	$\frac{a_{\pm}}{m_{\pm}/m^\circ}$	$\frac{a_{\pm}}{m_{\pm}/m^\circ}$	$\frac{a_{\pm}}{m_{\pm}/m^\circ}$	$\frac{a_{\pm}}{m_{\pm}/m^\circ}$



**TABLE 19.2. Relationships between Ionic Strength and Molality**

Salt	NaCl	Na <sub>2</sub> SO <sub>4</sub>	AlCl <sub>3</sub>	MgSO <sub>4</sub>	$A_{v_+} B_{v_-}$
Ionic Strength	$m_2$	$3 m_2$	$6 m_2$	$4 m_2$	$\frac{1}{2} v_- \left( \frac{v_-}{v_+} + 1 \right) z_-^2 m_2$

Thus, when calculating the mean molality of an electrolyte in a mixture, we must use the total molality of each ion, regardless of the source of the ion.

Both on the basis of empirical data and on the grounds of electrostatic theory, it has been found convenient to introduce a quantity known as the *ionic strength* when considering the effects of several electrolytes on the activity of one of them.

The contribution of each ion to the ionic strength  $I$  is obtained by multiplying the molality of the ion by the square of its charge. One half the sum of these contributions for all ions present is defined as the ionic strength. That is,

$$I = \frac{1}{2} \sum m_i z_i^2 \quad (19.25)$$

The factor one half has been included so that the ionic strength will be equal to the molality for a uni-univalent electrolyte. Thus, for NaCl,

$$\begin{aligned} I &= \left( \frac{1}{2} \right) [m_2(1)^2 + m_2(1)^2] \\ &= m_2 \end{aligned}$$

However, for BaCl<sub>2</sub>,

$$\begin{aligned} I &= \left( \frac{1}{2} \right) [m_2(2)^2 + 2m_2(1)^2] \\ &= 3m_2 \end{aligned}$$

because  $m_+ = m_2$  and  $m_- = 2m_2$ , in which  $m_2$  is the molality of the electrolyte. Several examples, together with a general formulation, are shown in Table 19.2.

## 19.2 DETERMINATION OF ACTIVITIES OF STRONG ELECTROLYTES

All methods used in the study of nonelectrolytes also can be applied *in principle* to the determination of activities of electrolyte solutes. However, in practice, several methods are difficult to adapt to electrolytes because it is impractical to obtain data for solutions sufficiently dilute to allow the necessary extrapolation to infinite dilution. For example, some data are available for the vapor pressures of the hydrogen halides in their aqueous solutions, but these measurements by themselves do not permit us to determine the activity of the solute because significant data cannot be obtained at concentrations below 4 molal.

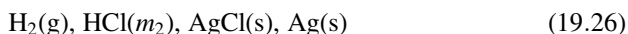
Activity data for electrolytes usually are obtained by one or more of three independent experimental methods: measurement of the potentials of electrochemical cells, measurement of the solubility, and measurement of the properties of the solvent, such as vapor pressure, freezing point depression, boiling point elevation, and osmotic pressure. All these solvent properties may be subsumed under the rubric *colligative properties*.

A great deal of information on activities of electrolytes also has been obtained by the isopiestic method, in which a comparison is made of the concentrations of two solutions with equal solvent vapor pressure. The principles of this method were discussed in Section 17.5.

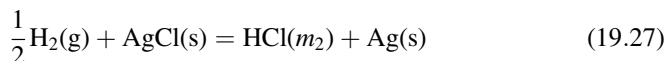
Once activity coefficients have been determined at one temperature by one of the methods mentioned above, calorimetric measurement of enthalpies of dilution can be used to determine activity coefficients at other temperatures.

### Measurement of Cell Potentials

For the cell composed of a hydrogen electrode and a silver–silver chloride (Ag–AgCl) electrode immersed in a solution of HCl, represented by the notation



the convention that we have adopted (see Section 17.4) describes the cell reaction as



By this convention, the potential of the cell is defined as the potential of the electrode on the right, at which reduction occurs, minus the potential of the electrode on the left, at which oxidation occurs.

We know from Equation (7.84) that the free energy change of the reaction is related to the cell potential by

$$\Delta G = -n \mathcal{F} \mathcal{E}$$

and from Equation (16.23) that  $\Delta G$  is related to the activities of reactants and products by

$$\Delta G = \Delta G^\circ + RT \ln \left( \frac{a_{\text{HCl}} a_{\text{Ag}}}{a_{\text{H}_2}^{1/2} a_{\text{AgCl}}} \right) \quad (19.28)$$

Substituting from Equation (7.84) into Equation (19.28), we obtain

$$-n \mathcal{F} \mathcal{E} = -n \mathcal{F} \mathcal{E}^\circ + RT \ln \left( \frac{a_{\text{HCl}} a_{\text{Ag}}}{a_{\text{H}_2}^{1/2} a_{\text{AgCl}}} \right) \quad (19.29)$$

or

$$\mathcal{E} = \mathcal{E}^\circ - \frac{RT}{n\mathcal{F}} \ln \frac{a_{\text{HCl}} a_{\text{Ag}}}{a_{\text{H}_2}^{1/2} a_{\text{AgCl}}} \quad (19.30)$$

If the pressure of hydrogen gas is maintained at the standard pressure of 1 bar, a pressure that is essentially equal to the fugacity, then the hydrogen can be considered to be in its standard state, with an activity equal to 1. As pure solid Ag and pure solid AgCl are in their standard states, their activities also are equal to 1. Thus, Equation (19.30) can be written as

$$\mathcal{E} = \mathcal{E}^\circ - \frac{RT}{n\mathcal{F}} \ln a_{\text{HCl}} \quad (19.31)$$

Hence, the cell indicated by Equation (19.26) can be used to determine the activity of dissolved HCl.

To apply Equation (19.31) to experimental data, we must specify our choice of standard states, because the values of  $\mathcal{E}^\circ$  and of  $a_{\text{HCl}}$  depend on this choice. We shall use the hypothetical unit molality ratio standard state obtained by extrapolation from the infinitely dilute solution. By convention,  $m^\circ$  is taken equal to 1 mol kg<sup>-1</sup>.

From Equations (19.5), (19.9), (19.10), and (19.18), we can write, for dissolved HCl,

$$\begin{aligned} a_{\text{HCl}} &= (a_{\text{H}^+})(a_{\text{Cl}^-}) \\ &= [(m_{\text{H}^+}/m^\circ)\gamma_{\text{H}^+}][m_{\text{Cl}^-}/m^\circ]\gamma_{\text{Cl}^-}] \\ &= (m_{\pm}/m^\circ)^2(\gamma_{\pm})^2 \end{aligned} \quad (19.32)$$

Substituting from Equation (19.32) into Equation (19.31), we have

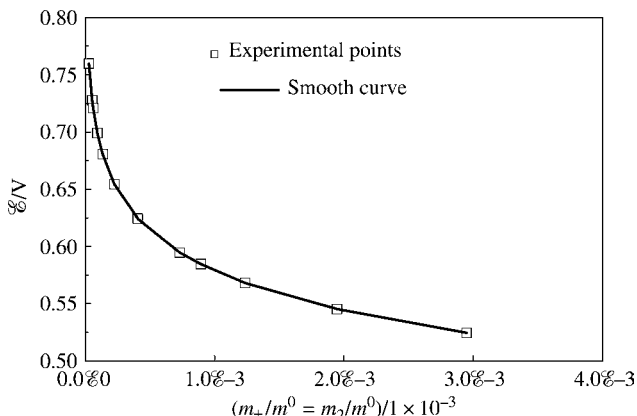
$$\begin{aligned} \mathcal{E} &= \mathcal{E}^\circ - \left(\frac{RT}{n\mathcal{F}}\right) \ln (m_{\pm}/m^\circ)^2(\gamma_{\pm})^2 \\ &= \mathcal{E}^\circ - 2\left(\frac{RT}{n\mathcal{F}}\right) \ln (m_{\pm}/m^\circ)(\gamma_{\pm}) \\ &= \mathcal{E}^\circ - 2\left(\frac{RT}{n\mathcal{F}}\right) \ln (m_{\pm}/m^\circ) - 2\left(\frac{RT}{n\mathcal{F}}\right) \ln \gamma_{\pm} \end{aligned} \quad (19.33)$$

We defined the limiting behavior of  $\gamma_{\pm}$  [Equation (19.11)] so that

$$\lim_{m_2 \rightarrow 0} \gamma_{\pm} = 1$$

Consequently

$$\lim_{m_2 \rightarrow 0} \ln \gamma_{\pm} = 0$$



**Figure 19.5.** Potentials at 25°C as a function of the molality ratio for the cell:  $H_2, HCl(m_2), AgCl, Ag$ . Data from unpublished work of T. F. Young and N. Anderson, used with permission.

and the third term on the right in Equation (19.33) becomes equal to zero in the limit of infinite dilution. However, the limit as  $m_2$  goes to zero of  $\ln(m_{\pm}/m^{\circ})$  is indeterminate, because the limit of  $m_{\pm}$  is equal to zero also, and the limit of  $\mathcal{E}$  as  $m_2$  goes to zero is indeterminate, as is illustrated in Figure 19.5.

Therefore, if we define a quantity  $\mathcal{E}'$  by the equation

$$\mathcal{E}' = \mathcal{E} + 2 \frac{RT}{n\mathcal{F}} \ln(m_{\pm}/m^{\circ}) \quad (19.34)$$

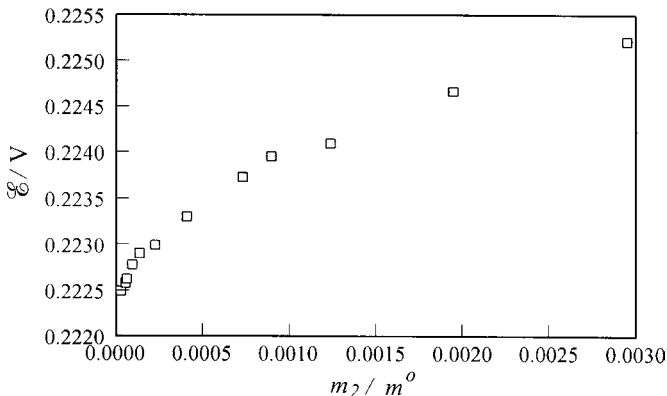
we can rewrite Equation (19.33) in the form

$$\mathcal{E}' = \mathcal{E}^{\circ} - 2 \frac{RT}{n\mathcal{F}} \ln \gamma_{\pm} \quad (19.35)$$

The value of  $\mathcal{E}'$  can be calculated from the experimental data with Equation (19.34), and the  $\ln \gamma_{\pm}$  on the right of Equation (19.35) goes to zero at infinite dilution. Therefore, an extrapolation of  $\mathcal{E}'$  to zero molality should yield a value of  $\mathcal{E}^{\circ}$ . That is,

$$\begin{aligned} \lim_{m_2 \rightarrow 0} \mathcal{E}' &= \lim_{m_2 \rightarrow 0} \left[ \mathcal{E} + 2 \left( \frac{RT}{n\mathcal{F}} \right) \ln(m_{\pm}/m^{\circ}) \right] \\ &= \lim_{m_2 \rightarrow 0} \left[ \mathcal{E}^{\circ} - 2 \left( \frac{RT}{n\mathcal{F}} \right) \ln \gamma_{\pm} \right] \\ &= \mathcal{E}^{\circ} \end{aligned} \quad (19.36)$$

If  $\mathcal{E}'$  is plotted against the molality ratio, as in Figure 19.6, the values approach the vertical axis with a very steep slope that makes extrapolation impossible. On the other hand, if  $\mathcal{E}'$  is plotted against the square root of the molality ratio, the



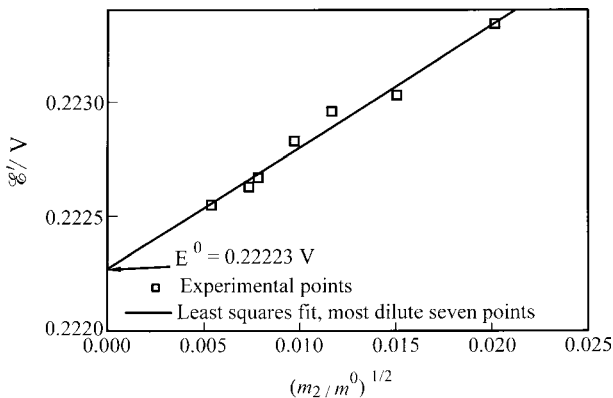
**Figure 19.6.** The quantity  $\mathcal{E}'$  at 25°C as a function of the molality ratio for the cell:  $H_2$ ,  $HCl(m_2)$ ,  $AgCl$ ,  $Ag$ . Data from unpublished work of T. F. Young and N. Anderson, used with permission.

extrapolation can be carried out to yield a precise value of  $\mathcal{E}^\circ$ , as shown in Figure 19.7. The choice of the square root was based both on experience with other data for electrolytes and on electrostatic theory.

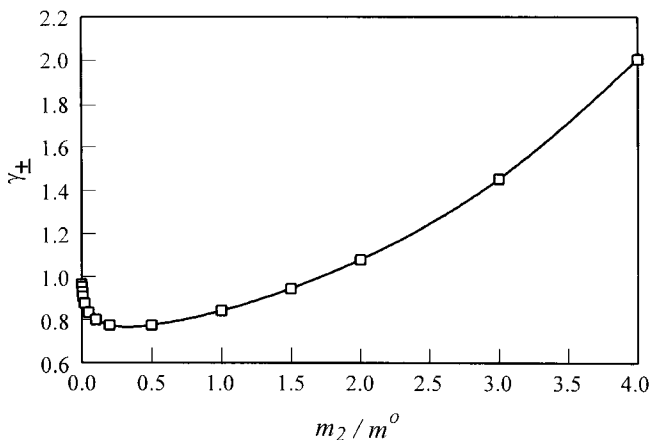
Having obtained  $\mathcal{E}^\circ$ , we can calculate mean activity coefficients from a rearrangement of Equation (19.34) to the form

$$\ln \gamma_{\pm} = \left( \frac{n\mathcal{F}}{2RT} \right) (\mathcal{E}^\circ - \mathcal{E}') \tag{19.37}$$

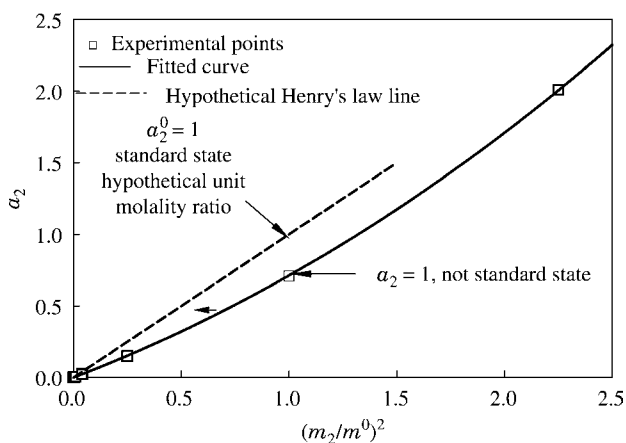
The mean activity coefficient  $\gamma_{\pm}$  for  $HCl$  is plotted against  $m_2/m^0$  over a wide range of concentration in Figure 19.8 as an example of the behavior of a uni-univalent



**Figure 19.7.** Appropriate axes for the extrapolation of  $\mathcal{E}'$  to determine  $\mathcal{E}^\circ$ . Original data the same as in Figures 19.5 and 19.6.



**Figure 19.8.** Mean activity coefficients of aqueous HCl at 25°C. Based on data from Ref. 2.



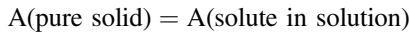
**Figure 19.9.** Activities of aqueous HCl as a function of the square of the molality ratio. Based on the same data as Figure 19.8.

electrolyte in aqueous solution. From these data [2], the activity  $a_2$  has been calculated, and it is illustrated as a function of the square of the molality in Figure 19.9; the dashed line indicates the limiting slope. The point on the dashed line corresponding to  $(m_2/m^0) = 1$  is the activity of the hypothetical unit molality ratio standard state.

### Solubility Measurements

As long as a pure solid  $A$  is in equilibrium with a dissolved solute  $A'$  the activity of the dissolved solute must be constant, because the activity of the solid  $a_s$  is constant at a fixed temperature and pressure. Thus, any change in the solubility with the addition of

other electrolytes must be from changes in the activity coefficient  $\gamma_{\pm}$  with changes in the ionic strength. For the reaction



the equilibrium constant for a uni-univalent solute is

$$\begin{aligned} K &= \frac{a_2}{a_{2(s)}} \\ &= \frac{a_2}{1} \\ &= a_+ a_- \\ &= a_{\pm}^2 \\ &= (C_{\pm}/C^{\circ})^2 \gamma_{\pm}^2 \end{aligned} \tag{19.38}$$

where we have used the molar concentration  $C$  instead of the molality  $m$  for this example.

In logarithmic form, Equation (19.38) becomes

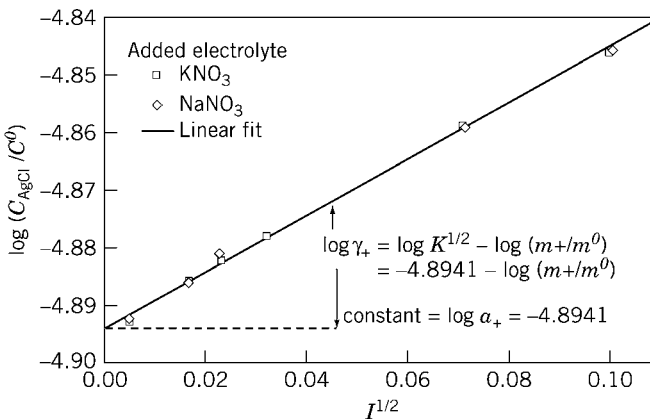
$$\log K^{1/2} = \log (C_{\pm}/C^{\circ}) + \log \gamma_{\pm} \tag{19.39}$$

As

$$\lim_{I \rightarrow 0} \gamma_{\pm} = 1$$

then

$$\lim_{I \rightarrow 0} \log (C_{\pm}/C^{\circ}) = \log K^{1/2} \tag{19.40}$$



**Figure 19.10.** Variation of solubility of AgCl with ionic strength, from which activity coefficients can be calculated. Data from Ref. 3.

To obtain a value of  $K$  by extrapolation, the appropriate functions to plot are the logarithm of the concentration ratio against the square root of the ionic strength  $I^{1/2}$ . Such a graph is shown in Figure 19.10 for solutions of AgCl in various aqueous electrolytes, based on the data of Popoff and Neuman [3]. From the extrapolated value for the constant  $K$ ,  $1.66 \times 10^{-10}$ , the following equation can be written for the mean activity coefficient of AgCl (because  $C_{\pm}$  equals  $C_{\text{AgCl}}$ ):

$$\log \gamma_{\pm} = -4.8941 - \log (C_{\text{AgCl}}/C^{\circ}) \quad (19.41)$$

### Colligative Property Measurement: The Osmotic Coefficient

As we saw in Section 17.5, the activity coefficient of a nonelectrolyte solute can be calculated from the activity coefficient of the solvent, which, in turn, can be obtained from the measurement of colligative properties such as vapor pressure lowering, freezing point depression, or osmotic pressure. We used the Gibbs–Duhem equation in the form [Equation (17.33)]

$$d \ln \gamma_2 = -\frac{X_1}{X_2} d \ln \gamma_1$$

The activity coefficients of solute and solvent are of comparable magnitudes in dilute solutions of nonelectrolytes, so that Equation (17.33) is a useful relationship. But the activity coefficients of an electrolyte solute differ substantially from unity even in very dilute solutions in which the activity coefficient of the solvent differs from unity by less than  $1 \times 10^{-3}$ . The data in the first three columns of Table 19.3 illustrate the situation. It can be observed that the calculation of the activity coefficient of solute from the activity coefficient of water would be imprecise at best.

To deal with this problem, Bjerrum [4] suggested that the deviation of solvent behavior from Raoult's law be described by the *osmotic coefficient*  $g$  rather than by the activity coefficient  $\gamma_1$ . The osmotic coefficient is defined by the relationships

$$\mu_1 = \mu_1^{\circ} + gRT \ln X_1 \quad (19.42)$$

**TABLE 19.3. Activity Coefficients and Osmotic Coefficients<sup>a</sup>**

$[\text{KNO}_3]/(\text{mol dm}^{-3})$	$\gamma(\text{KNO}_3)$	$\gamma(\text{H}_2\text{O})$	$g(\text{H}_2\text{O})$
0.01	0.8993	1.00001	0.9652
0.05	0.7941	1.00005	0.9252
0.1	0.7259	1.0002	0.8965
1.0	0.3839	1.0056	0.6891

<sup>a</sup>G. Scatchard, S. S. Prentice, and P. T. Jones, *J. Am. Chem. Soc.* **54**, 2690 (1932). The activity coefficient of the solute is based on the unit molarity ratio standard state, whereas the activity coefficient of the solvent is based on the unit mole fraction standard state.



and

$$\lim_{X_1 \rightarrow 1} g = 1 \quad (19.43)$$

The greater sensitivity, and hence usefulness, of  $g$  over  $\gamma_1$ , for solutions of electrolytes can be observed from the values in the third and fourth columns of Table 19.3.

Equating the expressions for  $\mu_1$  from Equation (16.1) and Equation (19.42) we obtain

$$\ln a_1 = g \ln X_1$$

or

$$g = \frac{\ln a_1}{\ln X_1} \quad (19.44)$$

When the activity of the solvent is determined from a colligative property, then  $g$  can be calculated with Equation (19.44). If we use osmotic pressure as an example, we can combine Equation (15.33) and Equation (16.1) to obtain the expression

$$\mu_1^\bullet(P_0) = \mu_1^\circ(P) + RT \ln a_1(P) \quad (19.45)$$

where  $P_0$  is the pressure on the pure solvent and  $P$  is the pressure on the solution. Therefore,

$$RT \ln a_1(P) = \mu_1^\bullet(P_0) - \mu_1^\circ(P) \quad (19.46)$$

Each of the two terms on the right in Equation (19.46) refers to pure solvent at the same temperature, but at a pressure of  $P_0$  for the first term and  $P$  for the second term. Thus, the right side of Equation (19.46) is also given by

$$\begin{aligned} \mu_1^\bullet(P_0) - \mu_1^\circ(P) &= \int_P^{P_0} \left( \frac{\partial \mu_1^\bullet}{\partial P} \right) dp \\ &= \int_P^{P_0} V_{m1}^\bullet dp \end{aligned} \quad (19.47)$$

As liquids are relatively incompressible,  $V_{m1}^\bullet$  can be assumed to be independent of pressure, and Equation (19.47) can be integrated to obtain

$$\mu_1^\bullet(P_0) - \mu_1^\circ(P) = V_{m1}^\bullet(P_0 - P) \quad (19.48)$$

If we again define  $P - P_0$  as the osmotic pressure,  $\pi$  and substitute from Equation (19.48) into Equation (19.46), we obtain

$$\ln a_1(P) = -\frac{V_{m1}^{\bullet} \Pi}{RT} \quad (19.49)$$

As indicated, the activity of solvent is at pressure  $P$ , and the small correction to pressure  $P_0$  can be obtained if desired from Equation (16.33). Substituting from Equation (19.49) into Equation (19.44), we find

$$g = \frac{-V_{m1}^{\bullet} \Pi / RT}{\ln X_1} \quad (19.50)$$

For a solution of electrolytes,

$$\begin{aligned} X_1 &= \frac{n_1}{n_1 + \sum_{+} n_{+} + \sum_{-} n_{-}} \\ &= \frac{n_1}{n_1 + \nu n_2} \end{aligned} \quad (19.51)$$

where  $\nu = \nu_1 + \nu_2$ . From Equation (19.51)

$$\begin{aligned} \ln X_1 &= \ln \left( \frac{n_1}{n_1 + \nu n_2} \right) \\ &= \ln \left( \frac{1}{1 + (\nu n_2 / n_1)} \right) \\ &= -\ln [1 + (\nu n_2 / n_1)] \end{aligned} \quad (19.52)$$

For the dilute solutions for which the osmotic coefficient is most useful, the natural logarithm in Equation (19.52) can be expanded in a Taylor's series, and terms of higher powers can be neglected. The result is

$$\ln X_1 = \frac{-\nu n_2}{n_1} \quad (19.53)$$

Substituting in Equation (19.50), we obtain

$$\Pi = (g\nu RT) \left( \frac{n_2}{n_1 V_{m1}^{\bullet}} \right) \quad (19.54)$$

The product  $n_1 V_{m1}^{\bullet}$  is essentially equal to  $V$ , the volume of solution, for dilute solutions, so that Equation (19.54) reduces to

$$\Pi = g\nu c_2 RT \quad (19.55)$$

It can be observed that  $g$  is the ratio between the observed osmotic pressure and the osmotic pressure that would be observed for a completely dissociated electrolyte that follows Henry's law [see Equation (15.47)], hence the name, osmotic coefficient. A similar result can be obtained for the boiling point elevation, the freezing point depression, and the vapor pressure lowering.

Once values of  $g$  as a function of solution composition have been obtained, the Gibbs–Duhem equation can be used to relate the osmotic coefficient of the solvent to the activity coefficient of the solute. For this purpose, the chemical potential of the solvent is expressed as in Equation (19.42), with the approximation given in Equation (19.53), so that

$$\mu_1 = \mu_1^\circ - RTvg \frac{n_2}{n_1} \quad (19.56)$$

If we describe the composition of the solution in terms of molalities, Equation (19.56) becomes

$$\mu_1 = \mu_1^\circ - RTv g m_2 M_1 \quad (19.57)$$

and

$$d\mu_1 = -RTv M_1 (g dm_2 + m_2 dg) \quad (19.58)$$

The chemical potential of the solute is

$$\begin{aligned} \mu_2 &= \mu_2^\circ + RT \ln a_2 \\ &= \mu_2^\circ + RT \ln(m_\pm/m^\circ)^v + RT \ln(\gamma_\pm)^v \\ &= \mu_2^\circ + vRT \ln(m_\pm/m^\circ) + vRT \ln \gamma_\pm \end{aligned} \quad (19.59)$$

If  $v_+ = v_- = 1$ , then  $m_\pm = m_2$ , and

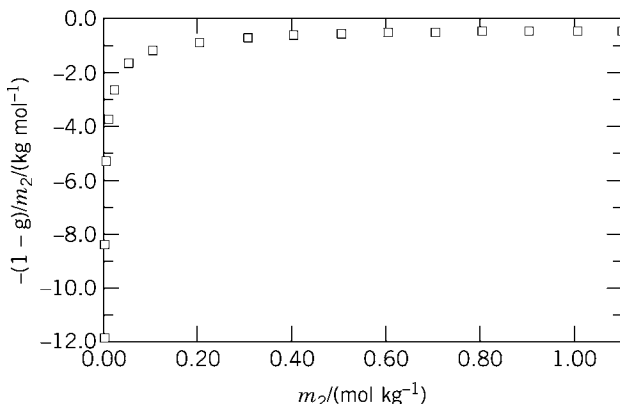
$$\begin{aligned} d\mu_2 &= vRT d \ln m_\pm + vRT d \ln \gamma_\pm \\ &= vRT d \ln m_2 + vRT d \ln \gamma_\pm \end{aligned} \quad (19.60)$$

If we use the Gibbs–Duhem equation in the form

$$d\mu_1 = -\left(\frac{n_2}{n_1}\right) d\mu_2$$

and we equate  $d\mu_1$  from Equation (19.58) with  $-n_2/n_1$  times  $d\mu_2$  from Equation (19.60), we obtain

$$d \ln \gamma_\pm = -\left(\frac{1-g}{m_2}\right) dm_2 + dg \quad (19.61)$$



**Figure 19.11.** A plot of  $-(1-g)/m_2$  against  $m_2$  from the freezing point data for potassium nitrate ( $\text{KNO}_3$ ) solutions in water. Data from G. Scatchard, S. S. Prentice, and P. T. Jones, *J. Am. Chem. Soc.* **54**, 2690 (1932). See Equation (19.63).

which is *Bjerrum's equation*. If Equation (19.61) is integrated from the infinitely dilute solution to some finite but still dilute molality, the result is

$$\int_0^{\ln \gamma_{\pm}} d \ln \gamma_{\pm} = - \int_0^{m_2} \left( \frac{1-g}{m_2} \right) dm_2 + \int_1^g dg \quad (19.62)$$

or

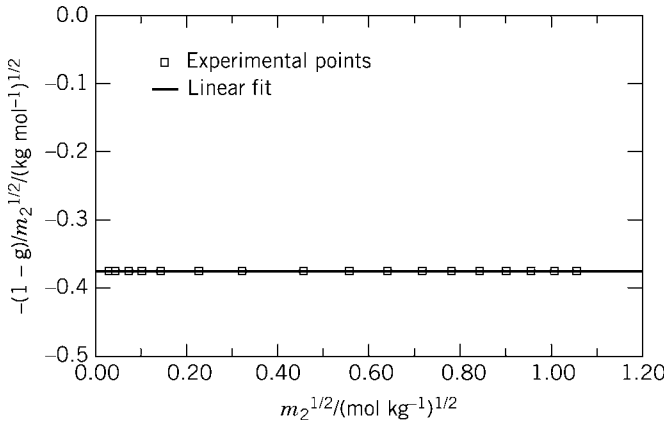
$$\ln \gamma_{\pm} = - \int_0^{m_2} \left( \frac{1-g}{m_2} \right) dm_2 + (g-1) \quad (19.63)$$

The integral in Equation (19.63) is usually evaluated graphically or numerically. Although both  $1-g$  and  $m_2$  go to zero as  $m_2 \rightarrow 0$ , the ratio has a finite limit. Such a finite limit is not apparent from a plot of  $(1-g)/m_2$  against  $m_2$  for electrolytes, as can be observed from Figure 19.11. But, if the integral in Equation (19.63) is transformed to

$$2 \int_0^{m_2^{1/2}} \left( \frac{1-g}{m_2^{1/2}} \right) d(m_2^{1/2}) \quad (19.64)$$

The finite limit can be observed clearly, as in Figure 19.12.

At concentrations beyond the region of validity of the expressions we have used for the osmotic coefficient, the activity coefficient of the solvent is sufficiently different from 1 that it can be used to calculate the activity coefficient of the solute.



**Figure 19.12.** A plot of  $-(1-g)/m^{1/2}$  against  $m^{1/2}$  from the same data as in Figure 19.11. See Equation (19.64).

### Extension of Activity Coefficient Data to Additional Temperatures with Enthalpy of Dilution Data

As with equilibrium constants [see Equation (10.24)], so it is sometimes convenient to measure activity coefficients at one temperature and to obtain values at other temperatures with the use of enthalpy data. From Equation (16.1)

$$\mu_2 = \mu_2^\circ + RT \ln a_2$$

and, from Equation (19.21)

$$a_2 = a_{\pm}^{\nu}$$

so that

$$\begin{aligned} \mu_2 &= \mu_2^\circ + RT \ln a_{\pm}^{\nu} \\ &= \mu_2^\circ + \nu RT \ln a_{\pm} \\ &= \mu_2^\circ + \nu RT \ln \gamma_{\pm} \left( \frac{m_{\pm}}{m^\circ} \right) \\ &= \mu^\circ + \nu RT \ln \gamma_{\pm} + \nu RT \ln \left( \frac{m_{\pm}}{m^\circ} \right) \end{aligned} \quad (19.65)$$

If we divide Equation (19.65) by  $T$ , we have

$$\frac{\mu_2}{T} = \frac{\mu_2^\circ}{T} + \nu R \ln \gamma_{\pm} + \nu R \ln \left( \frac{m_2}{m^\circ} \right) \quad (19.66)$$

If we differentiate Equation (19.66) with respect to  $1/T$ , we have

$$\left(\frac{\partial \mu_2/T}{\partial(1/T)}\right)_{P,m_2} = \left(\frac{\partial \mu_2^0/T}{\partial(1/T)}\right)_{P,m_2} + \nu R \ln \left(\frac{\partial \ln \gamma_{\pm}}{\partial(1/T)}\right)_{P,m_2} \quad (19.67)$$

From Equation (9.57)

$$\left(\frac{\partial(\mu_1/T)}{\partial(1/T)}\right) = -H_{m1}$$

Therefore, from Equations (19.67) and (9.57)

$$\begin{aligned} \left(\frac{\partial \ln \gamma_{\pm}}{\partial(1/T)}\right)_{P,m_2} &= (1/\nu R)(H_{m_2} - H_m^0) \\ &= (1/\nu R) \left[ -\frac{L_m}{T^2} \right] \end{aligned} \quad (19.68)$$

We see from Section 18.1 that  $L_{m_2}$  can be calculated from data for enthalpies of dilution fitted to a polynomial such as that in Equation (18.27). The result for  $L_{m_2}$  from Equation (18.28) is

$$L_{m_2} = 2A_1 m_2 + 3A_2 m_2^2 + \dots$$

Therefore

$$\left(\frac{\partial \ln \gamma_{\pm}}{\partial(1/T)}\right)_{P,m_2} = \frac{1}{\nu R T^2} (2A_1 m_2 + 3A_2 m_2^2 + \dots) \quad (19.69)$$

If  $\gamma$  is known as a function of  $m_2$  at some reference temperature  $T^*$ , then  $\gamma$  at other temperatures can be calculated by integration of Equation (19.69):

$$\begin{aligned} \ln(\gamma/\gamma^*) &= -\frac{1}{\nu R} \int_{T^*}^T \left( \frac{2A_1 m_2}{T^2} + \frac{3A_2 m_2^2}{T^2} + \dots \right) d(1/T) \\ &= -\frac{1}{\nu R} \int_{T^*}^T \left( \frac{2A_1 m_2}{T^2} + \frac{3A_2 m_2^2}{T^2} + \dots \right) \left( -\frac{1}{T^2} \right) dT \\ &= \frac{1}{\nu R} \int_{T^*}^T \left( \frac{2A_1 m_2}{T^4} + \frac{3A_2 m_2^2}{T^4} \dots \right) dT \end{aligned} \quad (19.70)$$

The data required to carry out such a calculation are the enthalpies of dilution as a function of molality at each temperature of interest. The integration would have to be carried out numerically. Enthalpy data for aqueous calcium chloride have been reported by Simonson, et al. [5].

### 19.3 ACTIVITY COEFFICIENTS OF SOME STRONG ELECTROLYTES

#### Experimental Values

With the experimental methods described, as well as with several others, the activity coefficients of numerous strong electrolytes of various valence types have been calculated. Many of these data have been assembled and examined critically by Harned and Owen [2]. More recent evaluations for uni-univalent electrolytes have been made by Hamer and Wu [6], and for uni-bivalent electrolytes by Goldberg [7]. Data used by the authors in Refs. 6 and 7 are fitted to an expression of the form

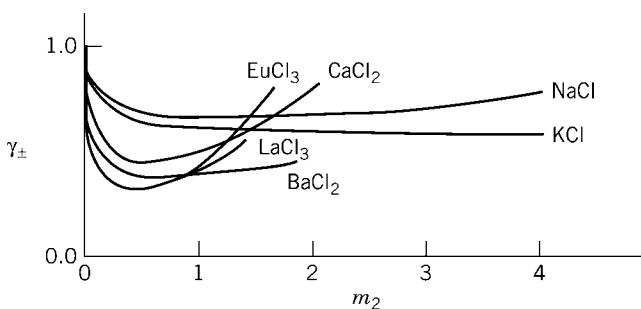
$$\log \gamma = \frac{-A|z_+z_-|I^{1/2}}{1 + BI^{1/2}} + \beta I + CI^2 + DI^3 + \dots \quad (19.71)$$

where  $A$  is the Debye–Hückel constant, and  $\beta$ ,  $B$ ,  $C$ , and  $D$  are empirical constants that result in a least squares best fit of the data. They use data from measurements of cell potentials, colligative properties, solubilities, and isopiestic measurements. Zemaitis et al. [8] have collected data for the activity coefficients of single strong electrolytes and mixtures of strong electrolytes, and they have also presented a review of the theoretical background.

The behavior of a few typical electrolytes is illustrated in Figure 19.13. By definition,  $\gamma_{\pm}$  is one at zero molality for all electrolytes. Furthermore, in every case,  $\gamma_{\pm}$  decreases rapidly with increasing molality at low values of  $m_2$ . However, the steepness of this initial drop varies with the valence type of the electrolyte. For a given valence type,  $\gamma_{\pm}$  is substantially independent of the chemical nature of the constituent ions, as long as  $m_2$  is below about 0.01. At higher concentrations, curves for  $\gamma_{\pm}$  begin to separate widely and to exhibit marked specific ion effects.

#### Theoretical Correlation

No adequate theoretical model based on the atomic characteristics of the ions has been developed yet that is capable of accounting for the thermodynamic properties



**Figure 19.13.** Mean activity coefficients at 25°C for some typical electrolytes in aqueous solution.

**TABLE 19.4. Values of Constants in Debye–Hückel Equation for Activity Coefficients in Aqueous Solutions<sup>a</sup>**

$T/K$	$A$	$B/10^9$
273.15	0.4904	3.245
278.15	0.4940	3.254
283.15	0.4978	3.262
288.15	0.5017	3.269
293.15	0.5059	3.277
298.15	0.5102	3.285
303.15	0.5147	3.293
308.15	0.5193	3.302
313.15	0.5242	3.310
318.15	0.5292	3.318
323.15	0.5344	3.327
328.15	0.5399	3.335
333.15	0.5455	3.344

<sup>a</sup>Fundamental constants and the densities of water used in calculating these constants were obtained from Ref. 10. Experimental values of the dielectric constant of water were obtained from Ref. 11.

of aqueous solutions over a wide range of concentration. However, for dilute solutions of completely ionized electrolytes, expressions have been derived [9] that predict exactly the limiting behavior of activity coefficients in an infinitely dilute solution, and that provide very useful equations for describing these quantities at small, finite concentrations. Although it is beyond the objectives of this text to consider the development of the Debye–Hückel theory, it is desirable to present some of the final results because they are of value in the treatment of experimental data.

According to the Debye–Hückel theory, in the limit of the infinitely dilute solution, individual-ion activity coefficients are given by the equation

$$\log \gamma_i = -Az_i^2 I^{1/2} \quad (19.72)$$

in which  $A$  is a constant for a given solvent at a specific temperature. Values of  $A$  for aqueous solutions are listed in Table 19.4. Equation (19.72) has been found useful up to  $I^{1/2}$  near 0.1, that is, for solutions with ionic strengths as high as 0.01. The mean activity coefficient  $\gamma_{\pm}$  is required for comparison with experimental data, and it can be shown from Equation (19.72) that for an *electrolyte with two kinds of ions*<sup>1</sup>

$$\log \gamma_{\pm} = -A|z_+z_-|I^{1/2} \quad (19.73)$$

in which  $z_+$  and  $z_-$  are the charge (equal to the valence) of the cation and anion, respectively. The symbol,  $|z_+z_-|$  is used to indicate absolute value, without regard to the sign of the charges.

<sup>1</sup>For the general case of any number of ions, see Ref. 1, p. 62.



At ionic strengths near 0.01, it is convenient to use the more complete form of the Debye–Hückel expression:

$$\log \gamma_{\pm} = \frac{-A|z_+z_-|I^{1/2}}{1 + Ba_iI^{1/2}} \quad (19.74)$$

in which  $A$  has the same significance as in Equation (19.73),  $B$  is a constant for a given solvent at a specified temperature (Table 19.4), and  $a_i$  may be thought of as the “effective diameter,” in units of meters, of the ion *in the solution*. As no independent method is available for evaluating  $a_i$ , this quantity is an empirical parameter, but the  $a_i$ ’s obtained from fitting experimental data to Equation (19.74) are of a magnitude expected for ion sizes.

For solutions above  $I = 0.1$ , various extensions of the Debye–Hückel theory have been proposed. The Debye–Hückel theory assumes that all strong electrolytes are ionized completely, takes into account only long-range electrostatic interactions between ions, and considers the solvent as a dielectric continuum. Attempts have been made to take account of ion association, ion–solvent interactions, and short-range interactions between ions. Some of these efforts are described in a monograph by Pitzer [12]. He has developed a set of semiempirical equations based on statistical thermodynamic theory that have been used widely to correlate data on activity and osmotic coefficients of electrolyte solutions over a wide range of temperatures and pressures, primarily for use by geochemists and in complex industrial processes (see, e.g., Ref. 13). An alternative statistical thermodynamic model has been used by Liu et al. [14], but they have only used this model at 298.15 K. Newman [15] has reported a new derivation of the Debye–Hückel limiting law from Kirkwood–Buff theory that permits extension to high concentrations of electrolyte with only two adjustable parameters. Horvath [16] described methods for estimating and correlating the physical properties of aqueous electrolytes. Barthel et al. [17] have reviewed both experimental results and models for solutions of electrolytes.

Raji Heyrovská [18] has developed a model based on incomplete dissociation, Bjerrum’s theory of ion-pair formation, and hydration numbers that she has found fits the data for NaCl solutions from infinite dilution to saturation, as well as several other strong electrolytes. She describes the use of activity coefficients and extensions of the Debye–Hückel theory as “best-fitting parameters” rather than as “explaining the significance of the observed results.”

## EXERCISES

- 19.1.** Prove that the following equation is valid for an electrolyte that dissociates into  $\nu$  particles:

$$\left( \frac{\partial \ln \gamma_{\pm}}{\partial T} \right)_{P, m_2} = - \frac{L_{m2}}{\nu RT^2} \quad (19.75)$$

**19.2.** For the equilibrium between a pure solute and its saturated solution,

$$\text{solute}_{(\text{pure})} = \text{solute}_{(\text{saturated soln})}$$

the equilibrium constant  $K$  is given by

$$K = \frac{a_{2,\text{satd}}}{a_{2,\text{pure}}} = \frac{a_{2,\text{satd}}}{1} \quad (19.76)$$

a. show that

$$\left( \frac{\partial \ln a_{2,\text{satd}}}{\partial T} \right)_P = - \frac{L_{m_2}^\bullet}{RT^2} \quad (19.77)$$

b. For the general case of an electrolyte that dissociates into  $\nu$  particles, show that

$$\nu \left[ \left( \frac{\partial \ln \gamma_{\pm,\text{satd}}}{\partial T} \right)_P + \left( \frac{\partial \ln m_{\pm,\text{satd}}}{\partial T} \right)_P \right] = - \frac{L_{m_2}^\bullet}{RT^2} \quad (19.78)$$

c. Considering  $\ln \gamma_{\pm}$  as a function of temperature and molality (pressure being maintained constant), show that

$$\left( \frac{\partial \ln \gamma_{\pm,\text{satd}}}{\partial T} \right)_P = \left( \frac{\partial \ln \gamma_{\pm}}{\partial T} \right)_{m_2,P} + \left( \frac{\partial \ln \gamma_{\pm}}{\partial m_2} \right)_{T,P} \left( \frac{\partial m_{2,\text{satd}}}{\partial T} \right) \quad (19.79)$$

d. Derive the equation

$$\left( \frac{\partial \ln \gamma_{\pm}}{\partial T} \right)_{m_2,P} + \left( \frac{\partial m_{2,\text{satd}}}{\partial T} \right)_P \left[ \left( \frac{\partial \ln \gamma_{\pm}}{\partial m_2} \right)_{T,P} + \left( \frac{1}{m_{2,\text{satd}}} \right) \right] - \frac{L_{m_2}^\bullet}{RT^2} \quad (19.80)$$

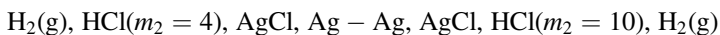
e. Use Equation (19.75) written for a saturated solution and Equation (19.80) to derive the following expression:

$$\Delta H_{m,\text{soln}} = \frac{\nu RT^2}{m_{2,\text{satd}}} \left( \frac{\partial m_{2,\text{satd}}}{\partial T} \right)_P \quad (19.81)$$

in which  $\Delta H_{m,\text{soln}}$  is the enthalpy change per mole of solute dissolved in the nearly saturated solution.

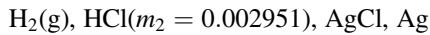
f. To what does Equation (19.81) reduce if the solute is a nonelectrolyte?

**19.3.** Calculate the electromotive force of the cell pair



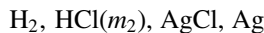
from vapor pressure data [1]. The value of  $p_{\text{HCl}}$  is  $0.2395 \times 10^{-4}$  atm for the 4-molal solution, and the value of  $p_{\text{HCl}}$  is  $55.26 \times 10^{-4}$  atm for the 10-molal solution.

**19.4.** The potential at 25°C of the cell



is 0.52393 V when the apparent barometric height (as read on a brass scale) is 75.10 cm Hg at 23.8°C and when the hydrogen is bubbled to the atmosphere through a column of solution 0.68 cm high. Calculate the partial pressure of the hydrogen in the cell, and the potential of the cell when the partial pressure of hydrogen in the cell is 1 Bar.

**19.5.** Unpublished data of T. F. Young and N. Anderson [19] for the potentials at 25°C of the cell



are given in Table 19.5.

- a. Plot  $\mathcal{E}'$  N against an appropriate composition variable, draw a smooth curve, and determine  $\mathcal{E}^\circ$  by extrapolation.
- b. On the graph in (a) show the geometric equivalent of the activity coefficient.
- c. Draw the asymptote predicted by the Debye–Hückel limiting law for the curve in (a).

**TABLE 19.5. Potentials of the Cell  $\text{H}_2, \text{HCl}(m_2), \text{AgCl}, \text{Ag}$  at 25°C<sup>a</sup>**

$m_{\pm}^{1/2}/(\text{mol kg}^{-1})^{1/2}$	$m_{\pm}/(\text{mol kg}^{-1})^a$	$\mathcal{E}/\text{V}$	$\log(m_{\pm}/m^\circ)$	$\mathcal{E}'/\text{V}$
0.054322	0.0029509	0.52456	-2.53005	0.22524
0.044115	0.0019461	0.54541	-2.71083	0.22471
0.035168	0.0012368	0.56813	-2.90770	0.22413
0.029908	0.0008945	0.58464	-3.04842	0.22399
0.027024	0.0007303	0.59484	-3.13650	0.22378
0.020162	0.0004065	0.62451	-3.39094	0.22334
0.015033	0.00022599	0.65437	-3.64591	0.22303
0.011631	0.00013528	0.68065	-3.86877	0.22296
0.009704	0.00009417	0.69914	-4.02606	0.22283
0.007836	0.00006140	0.72096	-4.21185	0.22267
0.007343	0.00005392	0.72759	-4.26827	0.22263
0.005376	0.000028901	0.75955	-4.53909	0.22255

<sup>a</sup>In the most dilute solutions studied, the molality of chloride ion was considerably greater than the molality of the hydrogen ion, because of the solubility of AgCl. Therefore, the mean molality  $m_{\pm}$  is tabulated, rather than the molality of either ion.

- d. Determine the mean activity coefficient of the ions of HCl at  $m_{\pm} = 0.001$ , 0.01, and 0.1, respectively. Compare these values with those computed from the Debye–Hückel limiting law.
- e. What error is introduced into the calculated activity coefficients by an error of  $0.00010$  V in  $\mathcal{E}$  or  $\mathcal{E}^{\circ}$ ?

**19.6.** Table 19.6 lists Popoff and Neuman's values [3] of the solubility of silver chloride (AgCl) in water containing "solvent" electrolytes at the concentrations indicated. According to the same authors, the solubility of silver chloride in pure water is  $1.278 \times 10^{-5}$  mole  $L^{-1}$ .

- a. Using distinctive symbols to represent each of the four series of data, plot (with reference to a single pair of axes) the solubility of silver chloride

**TABLE 19.6. Values of the Solubility of Silver Chloride in Water Containing Solvent Electrolytes at the Concentration Indicated [3]**

Concentration of Solvent Electrolyte/ (mole liter <sup>-1</sup> )	Concentration of AgCl/(10 <sup>-5</sup> mole liter <sup>-1</sup> )	<i>I</i>	<i>I</i> <sup>1/2</sup>	$-\log[(\text{AgCl})/C^{\circ}]$
<b>KNO<sub>3</sub></b>				
0.00001280	1.280	0.0000256	0.00506	4.8928
0.0002609	1.301	0.0002739	0.01655	4.8857
0.0005090	1.311	0.0005221	0.02285	4.8824
0.001005	1.325	0.001018	0.03191	4.8778
0.004972	1.385	0.004986	0.07061	4.8586
0.009931	1.427	0.009945	0.09972	4.8456
<b>NaNO<sub>3</sub></b>				
0.00001281	1.281	0.0000250	0.00506	4.8925
0.0002643	1.300	0.0002773	0.01665	4.8861
0.0005157	1.315	0.0005289	0.02300	4.8811
0.005039	1.384	0.005053	0.07108	4.8589
0.010076	1.428	0.010090	0.10045	4.8453
<b>HNO<sub>3</sub></b>				
0.0000128	1.280	0.0000256	0.00506	4.8928
0.0007233	1.318	0.0007365	0.02714	4.8801
0.002864	1.352	0.0028775	0.05364	4.8690
0.005695	1.387	0.005709	0.07556	4.8579
0.009009	1.422	0.009023	0.09499	4.8471
<b>Ba(NO<sub>3</sub>)<sub>2</sub></b>				
0.00000640	1.280	0.0000320	0.00566	4.8928
0.00003615	1.291	0.0001214	0.01102	4.8891
0.00121108	1.309	0.0006463	0.02542	4.8831
0.0007064	1.339	0.002133	0.04618	4.8732
0.001499	1.372	0.004511	0.06716	4.8627
0.002192	1.394	0.006590	0.08118	4.8557
0.003083	1.421	0.009263	0.09624	4.8474

- versus the concentration of each solvent electrolyte. On the same graph, plot the solubility of silver chloride against three times the concentration of barium nitrate.
- Show that these data are in accordance with the ionic-strength principle.
  - Verify several of the tabulated values of the total ionic strength; then plot the logarithm of the reciprocal of the solubility versus the square root of the ionic strength.
  - Draw a line representing the Debye–Hückel limiting law for comparison with the data.
  - Determine the activity of AgCl in a solution containing only silver chloride and in solutions in which the ionic strength is 0.001 and 0.01, respectively.
  - Calculate the solubility product of silver chloride. What is the activity of silver chloride in any of the saturated solutions?
- 19.7.** From the vapor pressure data in the International Critical Tables [20], calculate the activity of the water in 1.0-, 2.0-, 2.8-, and 4.0-molal NaCl solutions at 25°C.
- 19.8.** Calculate the potential of each of the following cells at 25°C. Use approximate values of the activity coefficient as calculated from the Debye–Hückel limiting law.
- $\text{H}_2$ ,  $\text{HCl}(m_2 = 0.0001)$ ,  $\text{Cl}_2\text{--Cl}_2$ ,  $\text{HCl}(m_2 = 0.001)$ ,  $\text{H}_2$ .
  - $\text{Mg}$ ,  $\text{MgSO}_4(m_2 = 0.001)$ ,  $\text{Hg}_2\text{SO}_4$ ,  $\text{Hg--Hg}$ ,  $\text{Hg}_2\text{SO}_4$ ,  $\text{MgSO}_4(m_2 = 0.0001)$ ,  $\text{Mg}$ .
- 19.9.** Table 19.7 contains data of Harned and Nims [21] for the cell Ag, AgCl, NaCl( $m_2 = 4$ ), Na(amalgam)–Na(amalgam), NaCl( $m_2 = 0.1$ ), AgCl, Ag in which both sodium amalgams have the same composition.
- Write the cell reaction.
  - Calculate  $\Delta H_{m_2}$  or  $\Delta L_{m_2}$  for the reaction in (a) at 25°C.
  - Compare the result in (b) with that which you would obtain from the direct calorimetric data of Table 19.8 [23].
  - How precise is the result in (b) if  $\mathcal{E}$  can be measured to  $\pm 0.00010$  V?

**TABLE 19.7. Potentials for AgCl, Na(amalgam) Cells at Several Temperatures**

T/°C	$\mathcal{E}/\text{V}$	$(\mathcal{E}/\text{T})/(\text{V}/\text{K})$
15	0.18265	0.00063398
20	0.18663	0.00063675
25	0.19044	0.00063885
30	0.19407	0.00064028
35	0.19755	0.00064119

**TABLE 19.8. Relative Partial Molar Enthalpies for NaCl(aq) at 25°C**

$m_2/(\text{mol kg}^{-1})$	$L_{m2}/(\text{cal mol}^{-1})$ at 25°C
0.1	96
0.2	84
0.3	57
0.4	20
0.5	-16
1.0	-185
2.0	-455
2.5	-548
3.0	-611
4.0	-669
5.0	-688

- e. Obtain activity coefficients for the solutions of NaCl in this cell [23]. Calculate the emf of the cell at 25°C. Compare your result with the value listed in Table 19.7.

**19.10.** The solubility (moles per kilogram of H<sub>2</sub>O) of cupric iodate, Cu(IO<sub>3</sub>)<sub>2</sub>, in aqueous solutions of KCl at 25°C, as determined by Keefer [24], is given in Table 19.9.

- a. Plot the logarithm to the base 10 of  $(m_{\text{Cu}^{2+}})(m_{\text{IO}_3^-})^2$  against  $I^{1/2}$  and fit the points to the equation

$$\log (m_{\text{Cu}^{2+}})(m_{\text{IO}_3^-})^2 = A + \frac{B I^{1/2}}{1 + C I^{1/2}} \quad (19.82)$$

by a nonlinear fitting procedure (see Section A.2).

- b. Use the Debye–Hückel coefficients in Table 19.4 and Equation (19.74) to calculate  $a_i$  in Equation (19.14).

**TABLE 19.9. Solubility of Cupric Iodate in Aqueous Solutions of KCl at 25°C**

$m_{\text{KCl}}/(\text{mol kg}^{-1})$	$m_{(\text{satd})\text{Cu}(\text{IO}_3)_2}/(10^{-3} \text{ mol kg}^{-1})$
0.00000	3.245
0.00501	3.398
0.01002	3.517
0.02005	3.730
0.03511	3.975
0.05017	4.166
0.07529	4.453
0.1005	4.694

- c. Show that  $\log K$  is equal to the constant  $A$  in Equation (19.82). Keefer reports a value of  $-7.1353$ .
- d. Draw a line representing the Debye–Hückel limiting law on the graph in (a).

## REFERENCES

1. G. N. Lewis and M. Randall, *Thermodynamics*, McGraw-Hill, New York, 1923. p. 336.
2. H. S. Harned and B. B. Owen, *The Physical Chemistry of Electrolytic Solutions*, 3rd ed., Reinhold, New York, 1958, p. 466.
3. S. Popoff and E. W. Neuman, *J. Phys. Chem.* **34**, 1853 (1930).
4. N. Bjerrum, *Z. Electrochem.* **24**, 321 (1918); *Z. Phys. Chem.* **104**, 406 (1932).
5. J. M. Simonson, R. H. Busey, and R. E. Mesmer, *J. Phys. Chem.* **89**, 557 (1985).
6. W. J. Hamer and Young-chi Wu, *J. Phys. Chem. Ref. Data* **1**, 1047 (1972).
7. R. N. Goldberg, *J. Phys. Chem. Ref. Data* **10**, 671 (1981).
8. J. F. Zemaitis, Jr., D. M. Clark, M. Rafal, and N. C. Scrivner, *Handbook of Aqueous Electrolyte Thermodynamics*, Chapters IV and V, American Institute of Chemical Engineers, New York, 1986.
9. P. Debye and E. Hückel, *Physik. Z.* **24**, 185 (1923).
10. NIST Chemistry WebBook. <http://www.nist.gov>.
11. B. B. Owen, R. C. Miller, C. E. Milner, and H. L. Cogan, *J. Phys. Chem.* **65**, 2065 (1961).
12. K. S. Pitzer, *Activity Coefficients in Electrolyte Solutions*, 2nd ed., CRC Press, Boca Raton, FL, 1991; See also H.-T. Kim and W. J. Fredericks, Jr., *J. Chem. Eng. Data* **33**, 177 (1988).
13. H. F. Holmes and R. E. Mesmer, *J. Solution Chem.* **15**, 495 (1986).
14. Y. Liu, A. H. Harvey, and J. M. Prausnitz, *Chem. Eng. Comm.* **77**, 43 (1989); Y. Liu and U. Grén, *Chem. Eng. Science* **46**, 1815 (1991).
15. K. E. Newman, *J. Chem. Soc., Faraday Trans. I* **85**, 485 (1989).
16. A. L. Horvath, *Handbook of Aqueous Electrolyte Solutions*, Ellis Horwood Press, Chichester, UK, 1985.
17. J. M. G. Barthel, H. Krienke, and W. Kunz, *Physical Chemistry of Electrolyte Solutions*, Springer, New York, 1998.
18. R. Heyrovská, *Electroanalysis* **18**, 351–361 (2006).
19. N. J. Anderson, Ph. D. Dissertation, University of Chicago, 1934.
20. *International Critical Tables*, Vol. III, p. 297, McGraw-Hill, New York, 1926.
21. H. S. Harned and L. F. Nims, *J. Am. Chem. Soc.* **54**, 423 (1932).
22. E. E. Messikomer and R. H. Wood, *J. Chem. Thermodynamics* **7** 119 (1975).
23. K. S. Pitzer, J. C. Peiper, and R. H. Busey, *J. Phys. Chem. Ref. Data* **13**, 1 (1984).
24. R. M. Keefer, *J. Am. Chem. Soc.* **70** 476 (1948). Reprinted with permission. Copyright American Chemical Society.

## CHAPTER 20

---

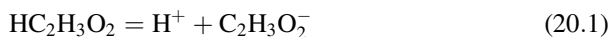
# CHANGES IN GIBBS FUNCTION FOR PROCESSES IN SOLUTIONS

---

Deviations from ideality in real solutions have been discussed in some detail to provide an experimental and theoretical basis for precise calculations of changes in the Gibbs function for transformations involving solutions. We shall continue our discussions of the principles of chemical thermodynamics with a consideration of some typical calculations of changes in Gibbs function in real solutions.

### 20.1 ACTIVITY COEFFICIENTS OF WEAK ELECTROLYTES (1)

Let us consider a typical weak electrolyte, such as acetic acid, whose ionization can be represented by the equation



We defined the activity coefficient for strong electrolytes in Chapter 19 in Equations (19.9) and (19.24) as

$$\gamma_+ = \frac{a_+}{m_+/m^\circ}$$
$$\gamma_- = \frac{a_-}{m_-/m^\circ}$$



and

$$\gamma_{\pm} = \frac{a_{\pm}}{m_{\pm}/m^{\circ}}$$

and disregarded the possibility of incomplete dissociation.

As it is possible to measure (or closely approximate) the ionic concentrations of a weak electrolyte, it is convenient to define ionic activity coefficients for weak electrolytes in the same way, based on the *actual* ionic concentrations,  $m_{+}$  or  $m_{-}$ . Thus,

$$\begin{aligned}\gamma_{+} &= \frac{a_{+}}{m_{+}/m^{\circ}} \\ \gamma_{-} &= \frac{a_{-}}{m_{-}/m^{\circ}}\end{aligned}\tag{20.2}$$

and

$$\gamma_{\pm} = \left[ \frac{(a_{+})(a_{-})}{(m_{+})m_{-}} \right]^{1/2} \left( \frac{1}{m^{\circ}} \right)\tag{20.3}$$

Similarly, for the undissociated species of molality  $m_u$ ,

$$\gamma_u = \frac{a_u}{(m_u/m^{\circ})}\tag{20.4}$$

The degree of dissociation  $\alpha$  of a uni-univalent weak electrolyte such as acetic acid is given by the equation

$$\alpha = \frac{m_{+}}{m_s} = \frac{m_{-}}{m_s}\tag{20.5}$$

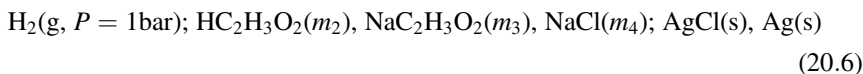
where  $m_s$  is the stoichiometric or total molality of acetic acid.

## 20.2 DETERMINATION OF EQUILIBRIUM CONSTANTS FOR DISSOCIATION OF WEAK ELECTROLYTES

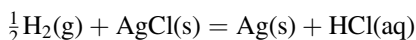
Three experimental methods that are capable of determining dissociation constants with a precision of the order of tenths of 1% have been most commonly used. Each of these methods—the cell potential method (2), the conductance method (3), and the optical method (4)—provides data that can be treated approximately, assuming that the solutions obey Henry's law, or more exactly on the basis of the methods developed in Chapter 19. We will apply the more exact procedures. As the optical method can be used only if the acid and conjugate base show substantial differences in absorption of visible or ultraviolet light, or differences in raman scattering or with the use of indicators, we shall limit our discussion to the two electrical methods.

### From Measurements of Cell Potentials

It is possible to select a cell that contains a weak acid in solution whose potential depends on the ion concentrations in the solution and hence on the dissociation constant of the acid. As an example, we will consider acetic acid in a cell that contains a hydrogen electrode and a silver–silver chloride electrode:



As the reaction that occurs in this cell is [Equation (19.27)]



the cell potential must be given by the expression [from Equations (19.30)–(19.32)]

$$\begin{aligned} \mathcal{E} &= \mathcal{E}^\circ - \frac{RT}{\mathcal{F}} \ln a_{\text{HCl}} \\ &= \mathcal{E}^\circ - \frac{RT}{\mathcal{F}} \ln \frac{m_{\text{H}^+} m_{\text{Cl}^-} \gamma_{\text{H}^+} \gamma_{\text{Cl}^-}}{(m^\circ)^2} \end{aligned}$$

As the molality  $m_{\text{H}^+}$  depends on the acetic acid equilibrium, which we can indicate in a simplified notation by the equation



where  $\text{Ac}^-$  stands for the acetate ion, we can introduce the dissociation constant  $K$  for acetic acid into the equation for the cell potential. For acetic acid,  $K$  is given by

$$K = \frac{m_{\text{H}^+} m_{\text{Ac}^-} \gamma_{\text{H}^+} \gamma_{\text{Ac}^-}}{m_{\text{HAc}} \gamma_{\text{HAc}}} \left( \frac{1}{m^\circ} \right) \quad (20.8)$$

from which  $m_{\text{H}^+}$  can be expressed in terms of the other variables and can be substituted into Equation (19.32). Thus, we obtain

$$\mathcal{E} = \mathcal{E}^\circ - \frac{RT}{\mathcal{F}} \ln \left( K \frac{m_{\text{HAc}} m_{\text{Cl}^-} \gamma_{\text{Cl}^-} \gamma_{\text{HAc}}}{m_{\text{Ac}^-} m^\circ \gamma_{\text{Ac}^-}} \right) \quad (20.9)$$

This equation can be rearranged to the form

$$\mathcal{E} - \mathcal{E}^\circ + \frac{RT}{\mathcal{F}} \ln \frac{m_{\text{HAc}} m_{\text{Cl}^-}}{m_{\text{Ac}^-} m^\circ} = -\frac{RT}{\mathcal{F}} \ln K - \frac{RT}{\mathcal{F}} \ln \frac{\gamma_{\text{Cl}^-} \gamma_{\text{HAc}}}{\gamma_{\text{Ac}^-}} \equiv \frac{-RT}{\mathcal{F}} \ln K' \quad (20.10)$$

in which

$$K' \equiv K \frac{\gamma_{\text{Cl}^-} \gamma_{\text{HAc}}}{\gamma_{\text{Ac}^-}} \quad (20.11)$$

All terms on the left in Equation (20.10) are known from previous experiments (see Section 19.2 for the determination of  $\mathcal{E}^\circ$ ) or can be calculated from the composition of the solution in the cell. Thus [see Equation (20.6)],

$$m_{\text{Cl}^-} = m_4 \quad (20.12)$$

$$m_{\text{HAc}} = m_2 - m_{\text{H}^+} \quad (20.13)$$

and

$$m_{\text{Ac}^-} = m_3 + m_{\text{H}^+} \quad (20.14)$$

Generally,  $m_{\text{H}^+} \ll m_2$  or  $m_3$ , so it can be estimated from Equation (20.8) by inserting an approximate value of  $K$  and neglecting the activity coefficients. Thus, it is possible to obtain tentative values of  $-(RT/\mathcal{F}) \ln K'$  and hence  $K'$  at various concentrations of acetic acid, sodium acetate, and sodium chloride, respectively. The ionic strength  $I$  can be estimated as

$$I = m_3 + m_4 + m_{\text{H}^+} \quad (20.15)$$

It can be observed from the limiting behavior of activity coefficients [Equation (19.11)] that

$$\lim_{I \rightarrow 0} \frac{\gamma_{\text{Cl}^-} \gamma_{\text{HAc}}}{\gamma_{\text{Ac}^-}} = 1 \quad (20.16)$$

Thus, if

$$-\frac{RT}{\mathcal{F}} \ln K'$$

or  $K'$  is plotted against some function of the ionic strength and extrapolated to  $I = 0$ , the limiting form of Equation (20.10) is

$$\lim_{I \rightarrow 0} \frac{RT}{\mathcal{F}} \ln K' = \frac{RT}{\mathcal{F}} \ln K \quad (20.17)$$

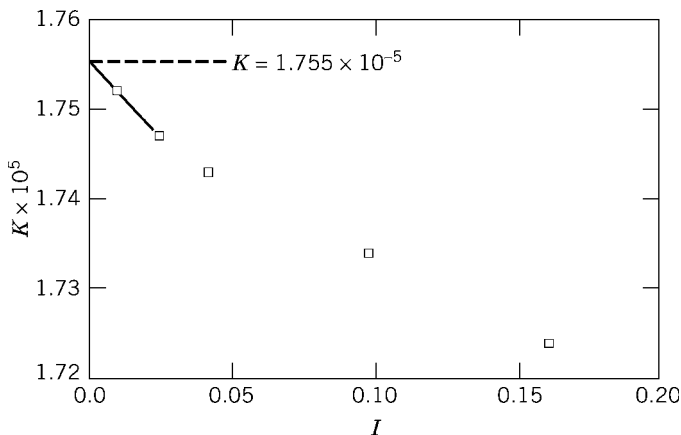
and

$$\lim_{I \rightarrow 0} K' = K \quad (20.18)$$

It has been found that the ionic strength to the first power as the abscissa yields a meaningful extrapolation.

A typical extrapolation of the data for acetic acid is illustrated in Figure 20.1. At 25°C the value of  $1.755 \times 10^{-5}$  has been found for  $K$  by this method.

If the equilibrium constant is not already known fairly well, the  $K$  determined by this procedure can be looked on as a first approximation. It then can be used to estimate  $m_{\text{H}^+}$  for substitution into Equations (20.13)–(20.15), and a second extrapolation can be carried out. In this way a second value of  $K$  is obtained.



**Figure 20.1.** Extrapolation of  $K'$  values in the determination of the ionization constant of acetic acid at 25°C. Based on data from H. S. Harned and R. W. Ehlers, *J. Am. Chem. Soc.* **54**, 1350 (1932).

The process can then be repeated until successive estimates of  $K$  agree within the precision of the experimental data. The iterative calculation can be programmed for a computer.

### From Conductance Measurements

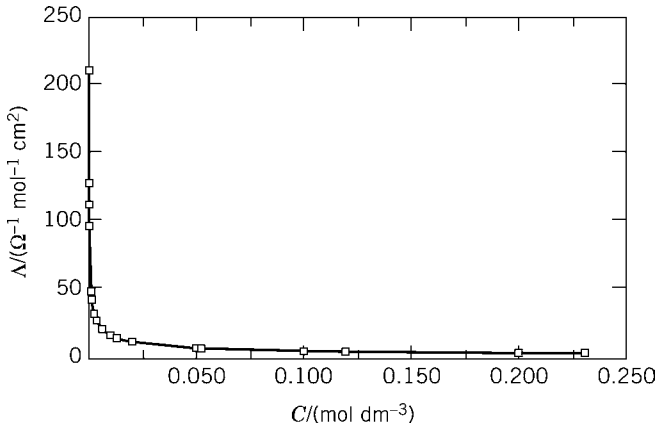
Conductance measurements also have been used for the estimation of dissociation constants of weak electrolytes. If we use acetic acid as an example, we find that the equivalent conductance  $\Lambda$  shows a strong dependence on concentration, as illustrated in Figure 20.2. The rapid decline in  $\Lambda$  with increasing concentration is largely from a decrease in the fraction of dissociated molecules.

In the approximate treatment of the conductance of weak electrolytes, the decrease in  $\Lambda$  is treated as resulting only from changes in the degree of dissociation,  $\alpha$ . On this basis, it can be shown that an apparent degree of dissociation  $\alpha'$  can be obtained from

$$\alpha' = \frac{\Lambda}{\Lambda_0} \quad (20.19)$$

in which  $\Lambda_0$  is the equivalent conductance of the weak electrolyte at infinite dilution. Hence, the apparent dissociation constant  $K'$  is obtainable from the expression

$$\begin{aligned} K' &= \frac{C'_{\text{H}^+} C'_{\text{Ac}^-}}{C'_{\text{HAc}} C^\circ} = \frac{(\alpha' C)(\alpha' C)}{(1 - \alpha') C C^\circ} \\ &= \frac{(\alpha')^2 C}{(1 - \alpha') C^\circ} = \frac{(\Lambda/\Lambda_0)^2 C}{[1 - (\Lambda/\Lambda_0)] C^\circ} \end{aligned} \quad (20.20)$$



**Figure 20.2.** Equivalent conductance of aqueous solutions of acetic acid at 25°C. Based on data from D. A. MacInnes and T. Shedlovsky, *J. Am. Chem. Soc.* **54**, 1429 (1932).

in which  $C$  is the total (stoichiometric) concentration of acetic acid in moles per liter. Generally,  $\Lambda_0$  is evaluated from data at infinite dilution for strong electrolytes. Thus, for acetic acid,  $\Lambda_0$  is obtained as follows:

$$\begin{aligned}\Lambda_0(\text{HAc}) &= \Lambda_0(\text{H}^+ + \text{Ac}^-) \\ &= \Lambda_0(\text{H}^+ + \text{Cl}^-) + \Lambda_0(\text{Na}^+ + \text{Ac}^-) - \Lambda_0(\text{Na}^+ + \text{Cl}^-) \quad (20.21) \\ &= \Lambda_0(\text{HCl}) + \Lambda_0(\text{NaAc}) - \Lambda_0(\text{NaCl})\end{aligned}$$

However, for more precise calculations, it is necessary to consider that the mobility (hence, the conductance) of ions changes with concentration, even when dissociation is complete, because of interionic forces. Thus, Equation (20.20) is oversimplified in its use of  $\Lambda_0$  to evaluate  $\alpha$ , because at any finite concentration, the equivalent conductances of the  $\text{H}^+$  and  $\text{Ac}^-$  ions, even when dissociation is complete, do not equal  $\Lambda_0$ .

To allow for the change in mobility resulting from changes in ion concentrations, MacInnes and Shedlovsky [5] proposed the use of a quantity  $\Lambda_e$  in place of  $\Lambda_0$ . The quantity  $\Lambda_e$  is the sum of the equivalent conductances of the  $\text{H}^+$  and  $\text{Ac}^-$  ions at the concentration  $C_i$  at which they exist in the acetic acid solution. For example, for acetic acid  $\Lambda_e$  is obtained from the equivalent conductances of HCl, NaAc, and NaCl at a concentration  $C_i$  equal to that of the ions in the solution of acetic acid. Thus, because

$$\Lambda_{\text{HCl}} = 426.04 - 156.70C^{1/2} + 165.5C(1 - 0.2274C^{1/2}) \quad (20.22)$$

$$\Lambda_{\text{NaAc}} = 90.97 - 80.48C^{1/2} + 90.0C(1 - 0.2274C^{1/2}) \quad (20.23)$$

and

$$\Lambda_{\text{NaCl}} = 126.42 - 88.53C^{1/2} + 89.5C(1 - 0.2274C^{1/2}) \quad (20.24)$$

the effective equivalent conductance  $\Lambda_e$  of completely dissociated acetic acid is given by

$$\begin{aligned} \Lambda_e &= \Lambda_{\text{HCl}} + \Lambda_{\text{NaAc}} - \Lambda_{\text{NaCl}} \\ &= 390.59 - 148.65C_i^{1/2} + 166.0C_i(1 - 0.22741C_i^{1/2}) \end{aligned} \quad (20.25)$$

Assuming that the degree of dissociation at the stoichiometric molar concentration  $C$  is given by the expression

$$\alpha'' = \frac{\Lambda}{\Lambda_e} \quad (20.26)$$

we obtain a better approximation for the dissociation constant than Equation (20.20):

$$K'' = \frac{C''_{\text{H}^+} C''_{\text{Ac}^-}}{C''_{\text{HAc}} C^\circ} = \frac{(\alpha'' C)^2}{(1 - \alpha'') C C^\circ} = \frac{(\Lambda/\Lambda_e)^2 C}{[1 - (\Lambda/\Lambda_e)] C^\circ} \quad (20.27)$$

Now if we insert appropriate activity coefficients, we obtain a third approximation for the dissociation constant:

$$K''' = \frac{C''_{\text{H}^+} C''_{\text{Ac}^-}}{C''_{\text{HAc}} C^\circ} \frac{\gamma_{\text{H}^+} \gamma_{\text{Ac}^-}}{\gamma_{\text{HAc}}} \quad (20.28)$$

This equation can be converted into logarithmic form to give

$$\log K''' = \log K'' + \log \left( \frac{\gamma_{\pm}^2}{\gamma_u} \right) \quad (20.29)$$

in which

$$\gamma_{\pm}^2 = \gamma_{\text{H}^+} \gamma_{\text{Ac}^-} \quad (20.30)$$

and

$$\gamma_u = \gamma_{\text{HAc}} \quad (20.31)$$

To evaluate  $\log K''$ , it is necessary to know  $\Lambda_e$  and, therefore,  $C_i$ . Yet to know  $C_i$  we must have a value for  $\alpha$ , which depends on a knowledge of  $\Lambda_e$ . In practice, this impasse is overcome by a method of successive approximations. To begin, we take  $\Lambda_e = \Lambda_0$  and make a first approximation for  $\alpha''$  from Equation (20.26). With this value of  $\alpha''$ , we can calculate a tentative  $C_i$ , which can be inserted into Equation (20.25) to give a tentative value of  $\Lambda_e$ . From Equation (20.25) and Equation (20.26), a new value of  $\alpha''$  is obtained, which leads to a revised value for  $C_i$  and subsequently for  $\Lambda_e$ . This method is continued until successive calculations give substantially the same value of  $\alpha''$ . Thus, for a 0.02000 molar solution of acetic acid, with an

equivalent conductance of  $11.563 \text{ ohms}^{-1} \text{ mol}^{-1} \text{ cm}^2$ , a first approximation for  $\alpha$  is

$$\alpha' = \frac{11.563}{390.59} = 0.029604$$

because  $\Lambda_0 = 390.50 \text{ ohms}^{-1} \text{ mol}^{-1} \text{ cm}^2$ . Therefore,

$$C_i = \alpha' C = 0.029604(0.02000) = 0.00059208 \text{ mol L}^{-1}$$

and

$$C_i^{1/2} = 0.024333$$

Substitution of this value of  $C_i^{1/2}$  into Equation (20.25) yields a value of

$$\Lambda_e = 387.07 \Omega^{-1} \text{ mol}^{-1} \text{ cm}^2$$

Coupling this value with 11.563 for  $\Lambda$ , we obtain

$$\alpha'' = \frac{11.563}{387.07} = 0.029873$$

$$C_i = 0.00059746 \text{ mol L}^{-1}$$

$$C_i^{1/2} = 0.024443$$

and

$$\Lambda_e = 387.06 \Omega^{-1} \text{ mol}^{-1} \text{ cm}^2$$

A third calculation of  $\alpha''$  gives 0.029874, which is substantially the same as the result of the second approximation; hence, it can be used in Equation (20.27). As with the iterative procedure for calculating equilibrium constants from data on cell potentials, the iterative procedure for conductance data can be programmed for a computer.

Once a value of  $\log K''$  is obtained, the value of  $\log K$  can be determined by an extrapolation procedure. From Equation (19.11),

$$\lim_{I \rightarrow 0} \gamma_{\pm}^2 = 1$$

and

$$\lim_{I \rightarrow 0} \log \gamma_{\pm}^2 = 0$$

From Equation (16.4),

$$\lim_{I \rightarrow 0} \gamma_u = \lim_{m_2 \rightarrow 0} \gamma_u = 1$$

and

$$\lim_{I \rightarrow 0} \log \gamma_u = 0$$

Thus, the limiting form of Equation (20.29) is

$$\lim_{I \rightarrow 0} \log K'' = \lim_{I \rightarrow 0} \log K''' = \log K \quad (20.32)$$

in which  $K$  is the thermodynamic dissociation constant.

The best functions to use in the extrapolation can be determined from the dependence of  $\gamma_{\pm}^2$  and  $\gamma_u$  on the ionic strength. Theoretically, little is known about the dependence of  $\gamma_u$  on concentration (6), but from the Debye–Hückel theory, we should expect  $\log \gamma_{\pm}^2$  to depend on  $I^{1/2}$ , with the dependence approaching linearity with increasing dilution.

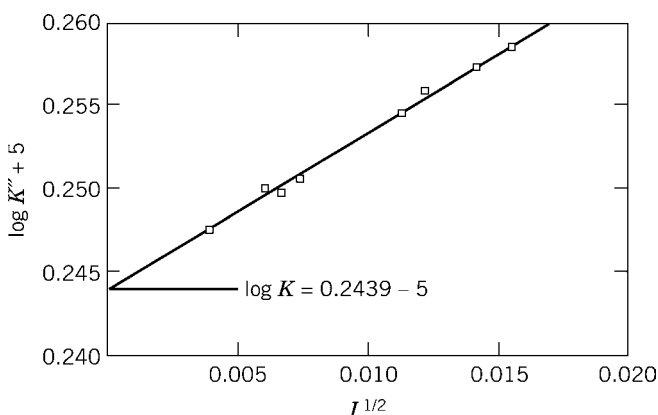
The data for acetic acid, when  $\log K''$  is plotted against the square root of the ionic strength (Fig. 20.3), provide a meaningful value for  $K$  by extrapolation. MacInnes and Shedlovsky [5] report a value for  $K$  of  $1.753 \times 10^{-5}$  at 25°C.

An alternative method of extrapolation, in which the slope is reduced almost to zero, can be carried out by the following modification of Equation (20.29). If we separate the activity coefficients, we obtain

$$\log K''' = \log K'' + \log \gamma_{\pm}^2 - \log \gamma_u \quad (20.33)$$

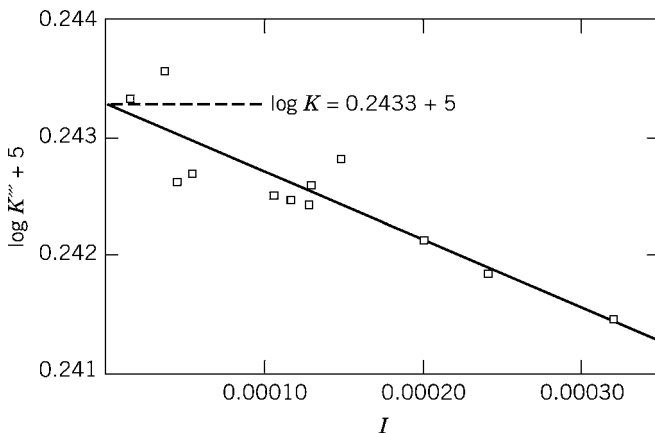
We know from experiment that  $\log \gamma_u$  is a linear function of  $I$ . The value of  $\log \gamma_{\pm}^2$  is described well by the Debye–Hückel limiting law in very dilute solution. Thus, we can substitute the expression

$$\log \gamma_{\pm}^2 = 2 \log \gamma_{\pm} = 2[-0.509|z_+z_-|I^{1/2}] = -1.018 I^{1/2} \quad (20.34)$$



**Figure 20.3.** Extrapolation of ionization constants of acetic acid.





**Figure 20.4.** Alternative method of extrapolation of ionization constants of acetic acid.

into Equation (20.33) and can rearrange the resultant equation into the relationship

$$\log K''' + \log \gamma_u = \log K'' - 1.018 I^{1/2} \equiv \log K''' \quad (20.35)$$

As both  $K''$  and  $I^{1/2}$  can be calculated from experimental data,  $\log K'''$  can be determined. A plot of  $\log K'''$  against  $I$  gives a curve with small slope, such as illustrated in Figure 20.4. The determination of the intercept in this graph is easier than it is in Figure 20.3 for uni-univalent electrolytes, and the improvement is greater when the dissociation process involves polyvalent ions.

Mesmer et al. [7] used conductance methods to determine ionization constants over a wide range of temperatures and pressures.

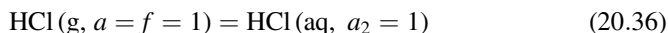
An alternative procedure uses the Fuoss conductance–concentration function to relate the measured conductance to the ionic concentrations at equilibrium (8).

### 20.3 SOME TYPICAL CALCULATIONS FOR $\Delta_f G_m^\circ$

#### Standard Gibbs Function for Formation of Aqueous Solute: HCl

We have discussed in some detail the various methods that can be used to obtain the standard Gibbs function of formation of a pure gaseous compound such as HCl(g). As many of its reactions are carried out in aqueous solution, it also is desirable to know  $\Delta_f G_m^\circ$  for HCl(aq).

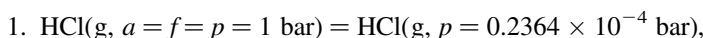
Our problem is to find  $\Delta G_m^\circ$  for the reaction



because to this  $\Delta G_m^\circ$  we always can add  $\Delta_f G_m^\circ$  of HCl(g). Although in Equation (20.36),  $a_{\text{HCl}}$  is 1 on both sides, the standard states are not the same for the

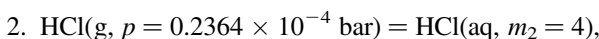
gaseous and aqueous phases; hence, the chemical potentials are not equal. To obtain  $\Delta G_m^\circ$  for Reaction (20.36), we can break up the reaction into a set of transformations for which we can find values of  $\Delta G_m$ .

We can write the following three equations, whose sum is equivalent to Equation (20.36):

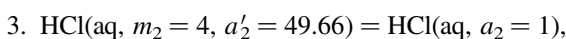


$$\Delta G_{m,298\text{ K}} = RT \ln \frac{0.2364 \times 10^{-4} \text{ bar}}{1 \text{ bar}} = -26.407 \text{ kJ mol}^{-1} \quad (20.37)$$

in which  $0.2364 \times 10^{-4}$  bar is the partial pressure of HCl(g) (9) in equilibrium with a 4-molal solution of HCl.



$$\Delta G_{m,298\text{ K}} = 0 \text{ (equilibrium reaction)} \quad (20.38)$$



$$\Delta G_{m,298\text{ K}} = RT \ln \frac{a_2}{a'_2} = RT \ln \frac{1}{49.66} = -9.680 \text{ kJ mol}^{-1} \quad (20.39)$$

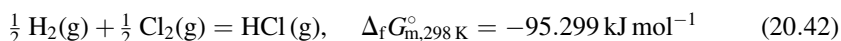
The activity of HCl in a 4-molal solution required for the  $\Delta G_m$  in Equation (20.39) was calculated from the mean activity coefficient, 1.762, taken from tables of Harned and Owen [10], as follows:

$$a_2 = m_{\pm}^2 \gamma_{\pm} = (4)^2 (1.762)^2 = 49.66 \quad (20.40)$$

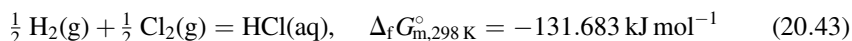
Now we can obtain the standard Gibbs function change for Equations (20.36), because the sum of Equations (20.37) through (20.39) yields

$$\text{HCl(g, } a = 1) = \text{HCl(aq, } a_2 = 1), \quad \Delta G_{m,298\text{ K}}^\circ = -36.384 \text{ kJ mol}^{-1} \quad (20.41)$$

Having obtained the standard Gibbs function change accompanying the transfer of HCl from the gaseous to the aqueous state, we can add it to the standard Gibbs function for formation of gaseous HCl [11],



and we can obtain the standard Gibbs function of formation of aqueous HCl:

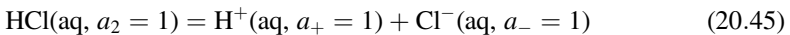


### Standard Gibbs Function of Formation of Individual Ions: HCl

As it has been shown that the Gibbs function for formation of an individual ion has no operational meanings [12], no way exists to determine such a quantity experimentally. However, for the purposes of tabulation and calculation, it is possible to separate  $\Delta_f G_m^\circ$  of an electrolyte *arbitrarily* into two or more parts, which correspond to the number of ions formed, in a way analogous to that used in tables of standard electrode potentials. In both cases, the standard Gibbs function for formation of aqueous  $H^+$  is defined to be zero at every temperature:



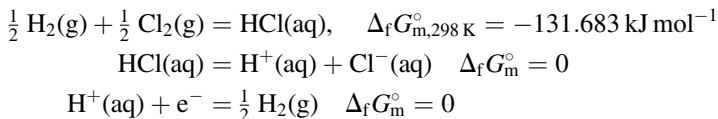
With this definition it is possible to calculate the standard Gibbs function of formation of other ions. For example, for  $Cl^-$  ion, we proceed by adding appropriate equations to Equation (20.44). For the reaction



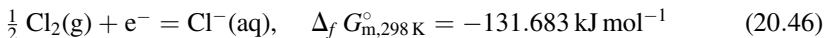
$\Delta G_m^\circ$  is equal to zero because our definition of the individual ion activities [Equation (20.5)] is

$$a_2 = (a_+)(a_-)$$

If we add Equation (20.45) to Equation (20.43) and then subtract Equation (20.44),



we obtain the standard Gibbs function for formation of  $Cl^-$  ion:

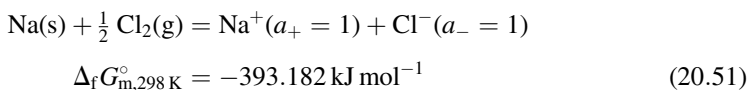
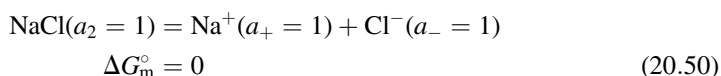
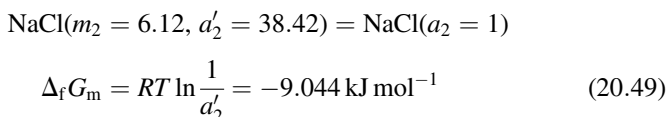
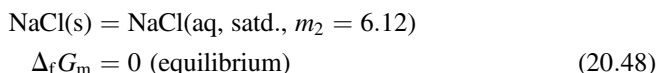
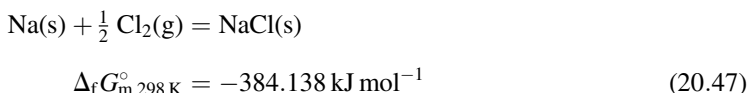


This  $\Delta_f G_m^\circ$  corresponds to the value that can be calculated from the standard electrode potential.

### Standard Gibbs Function for Formation of Solid Solute in Aqueous Solution

**Solute Very Soluble: Sodium Chloride.** As the standard Gibbs function for formation of  $NaCl(s)$  is available [11], the  $\Delta_f G_{m,298}^\circ$  for  $NaCl(aq)$  can be obtained

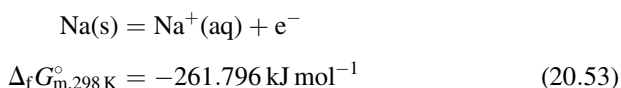
by a summation of the following processes:



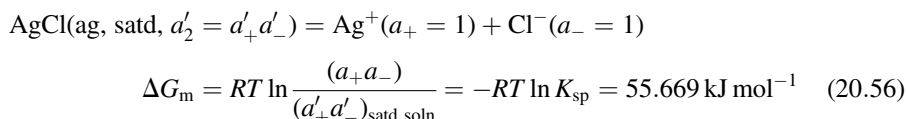
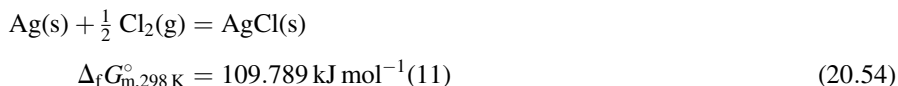
The value of  $a'_2$  in Equation (20.49) is obtained as follows:

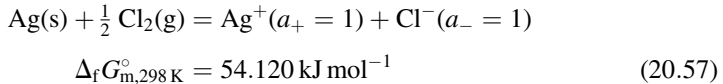
$$a'_2 = (a_+)(a_-) = \frac{(m_\pm)^2(\gamma_\pm)^2}{(m^\circ)^2} = \frac{(6.12)^2(1.013)^2}{(1.00)^2} = 38.42 \quad (20.52)$$

From the standard Gibbs function of formation of the aqueous electrolyte, we also can obtain that for the  $\text{Na}^+$  ion alone by subtracting Equation (20.46) from Equation (20.51). Thus, we obtain

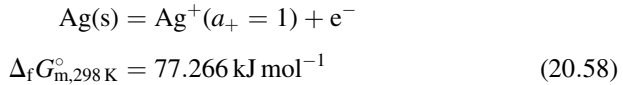


**Slightly Soluble Solute: Silver Chloride.** For  $\text{AgCl}$  we can add the following equations:



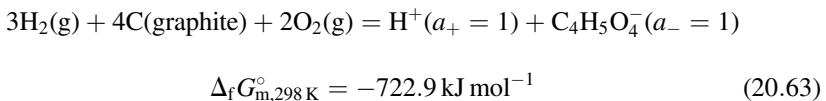
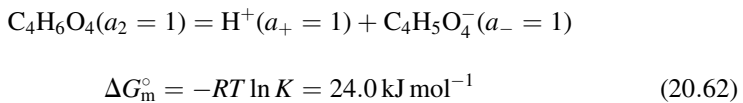
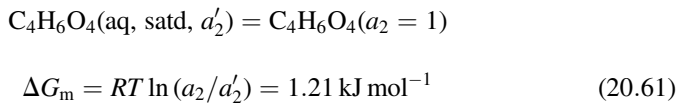
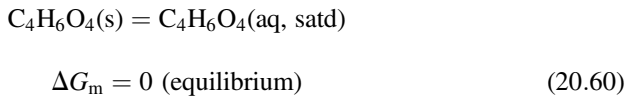
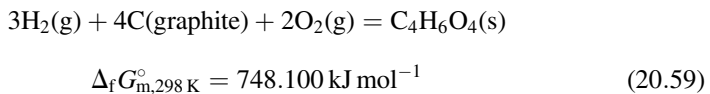


We can calculate a value for the  $\text{Ag}^+$  ion by subtracting Equation (20.46) from Equation (20.57). Thus, we obtain



### Standard Gibbs Function for Formation of Ion of Weak Electrolyte

As part of a program to determine the Gibbs function changes in the reactions by which glucose is oxidized in a living cell, Borsook and Schott (13) calculated the Gibbs function for the formation at  $25^\circ\text{C}$  of the first anion of succinic acid,  $\text{C}_4\text{H}_5\text{O}_4^-$ . The solubility of succinic acid in water at  $25^\circ\text{C}$  is 0.715 mole  $(\text{kg H}_2\text{O})^{-1}$ . In such a solution the acid is 1.12% ionized ( $\alpha = 0.0112$ ) and the undissociated portion has an activity coefficient of 0.87. As we know that the first dissociation constant of succinic acid is equal to  $6.4 \times 10^{-5}$ , we can calculate  $\Delta_f G_{\text{m}}^\circ$  of the  $\text{C}_4\text{H}_5\text{O}_4^-$  ion by adding the following equations:



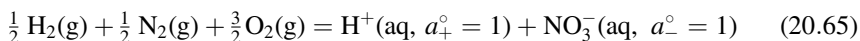
The value in Equation (20.63) is also the standard change in Gibbs function for the formation of the  $\text{C}_4\text{H}_5\text{O}_4^-$  ion because, by convention, the corresponding quantity for  $\text{H}^+$  is set equal to zero [see Equation (20.44)].

For the Gibbs function change in Equation (20.61),  $a'_2$  of the undissociated species of succinic acid in the saturated solution is obtained as follows:

$$\begin{aligned} a'_2 &= m_u \gamma_u = m_{\text{stoichiometric}}(1 - \alpha) \gamma_u \\ &= (0.715)(1 - 0.0112)(0.87) = 0.615 \end{aligned} \quad (20.64)$$

### Standard Gibbs Function for Formation of Moderately Strong Electrolyte

Moderately strong electrolytes, such as aqueous  $\text{HNO}_3$ , generally have been treated thermodynamically as completely dissociated substances. Thus, for  $\text{HNO}_3(\text{aq})$ , the value for  $\Delta_f G_m^\circ$  of  $-111.25 \text{ kJ mol}^{-1}$  listed in [Ref. 11] refers to the reaction



The activity of the nitric acid is defined by the equation

$$a_{\text{HNO}_3} = a_{\text{H}^+} a_{\text{NO}_3^-} = m_s^2 \gamma_{\pm}^2 \quad (20.66)$$

in which  $m_s$  is the stoichiometric (or total) molality of the acid.

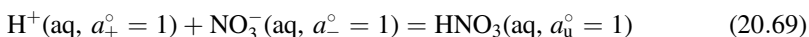
Optical and nuclear magnetic resonance methods applicable to moderately strong electrolytes have been made increasingly precise (14). By these methods, it has proved feasible to determine concentrations of the undissociated species and hence of the dissociation constants. Thus, for  $\text{HNO}_3$  in aqueous solution (14) at  $25^\circ\text{C}$ ,  $K$  is 24. However, in defining this equilibrium constant, we have changed the standard state for aqueous nitric acid, and the activity of the undissociated species is given by the equation

$$a'_{\text{HNO}_3} = m_u \gamma_u = a_u \quad (20.67)$$

in which the subscript “u” refers to the undissociated species. The standard states of the ions are unchanged despite the change in the standard state of the undissociated acid. The limiting law also is the same for the ions. Therefore, Equation (20.66) is no longer applicable, and in its place, we have

$$\frac{a_{\text{H}^+} a_{\text{NO}_3^-}}{a_u} = K = 24 \quad (20.68)$$

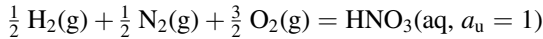
With the preceding considerations clearly in mind, we can calculate  $\Delta_f G_m^\circ$  of undissociated  $\text{HNO}_3$ . For this purpose, we can add the following equation to Equation (20.65):



For this reaction

$$\Delta G_m^\circ = -RT \ln \frac{1}{K} = 7.9 \text{ kJ mol}^{-1} \quad (20.70)$$

The sum of Reactions (20.65) and (20.69) is

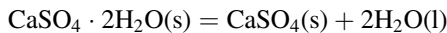


which is the formation of molecular, undissociated, aqueous  $\text{HNO}_3$ , and the sum of the  $\Delta G^\circ$ 's for Reactions (20.65) and (20.69) is the standard Gibbs function for formation of molecular, undissociated, aqueous  $\text{HNO}_3$

$$\Delta_f G_{m,298\text{K}}^\circ = -103.4 \text{ kJ mol}^{-1} \quad (20.71)$$

### Effect of Salt Concentration on Geological Equilibrium Involving Water

In Section 13.3, we discussed the gypsum–anhydrite equilibrium [Equation (13.16)]



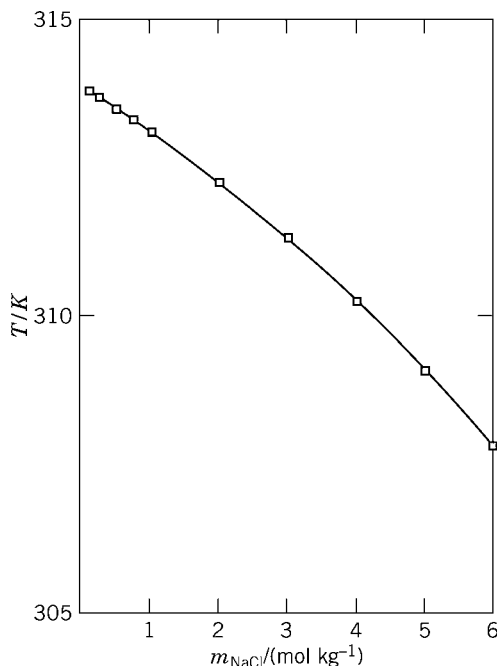
on the assumption that the liquid phase is pure water, and that  $\Delta G_m$  for the reaction is dependent only on  $T$ ,  $P_S$ , and  $P_F$  [Equation (13.17)]. If dissolved salt is in the water, as is likely in a rock formation, the chemical potential and activity of the water (as shown in Chapter 19) depend on the salt concentration, as does  $\Delta G_m$  for Equation (13.16). The equation for  $\Delta G_m$  would be a modified form of Equation (13.17) with a term taking into account possible variation in the activity of water, as follows (with  $P_S$  and  $P_F$  much greater than 1 bar):

$$\begin{aligned} \Delta G_m(P_F, P_S, T) &= \Delta G_m(P = 1, T, a_{\text{H}_2\text{O}} = 1) \\ &+ P_S(\Delta V_{m,S}) + P_F(\Delta V_{m,F}) + 2RT \ln X_{\text{H}_2\text{O}}\gamma_{\text{H}_2\text{O}} \end{aligned} \quad (20.72)$$

The osmotic coefficient of water in NaCl solutions of varying concentration can be calculated from data in Ref. 15. From the resulting values of the osmotic coefficients, the effect of NaCl concentration on the equilibrium temperature for Equation (13.16) can be determined. The results of some calculations for a constant pressure of 1 atm are shown in Figure 20.5 (16).

### General Comments

The preceding examples illustrate some methods that can be used to combine data for the Gibbs functions for pure phases with information on the Gibbs function for constituents of a solution to calculate changes in the Gibbs function for chemical



**Figure 20.5.** Effect of NaCl concentration on the equilibrium temperature of the anhydrite–gypsum reaction at 1 bar. Data from Ref. 16.

reactions of those compounds in solution. The examples discussed, together with some of the exercises at the end of this chapter, should help students apply the same principles to particular problems in which they are interested.

## 20.4 ENTROPIES OF IONS

In dealing with solutions, it frequently may be necessary to obtain values of  $\Delta G$  for a process in solution for which only thermal data are available. If standard entropy data also could be obtained for solutions, then it would be possible to calculate  $\Delta G^\circ$  from a calorimetric determination of  $\Delta H^\circ$  and from Equation (7.26):

$$\Delta G^\circ = \Delta H^\circ - T\Delta S^\circ$$

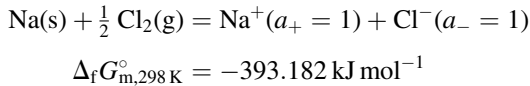
For aqueous solutions of electrolytes, a concise method of tabulating such entropy data is in terms of the individual ions, because entropies for the ions can be combined to give information for a wide variety of salts. The initial assembling of the ionic entropies generally is carried out by a reverse application of Equation (7.26); that is,  $\Delta_f S_m^\circ$  of a salt is calculated from known values of  $\Delta_f G_m^\circ$  and  $\Delta_f H_m^\circ$  for that salt. After a suitable convention has been adopted, the entropy of formation of the



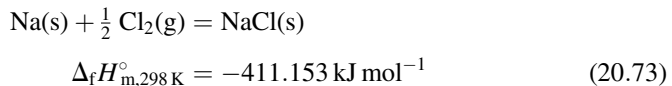
cation and anion together then can be separated into the entropies for the individual ions.

### The Entropy of an Aqueous Solution of a Salt

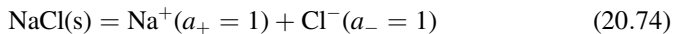
From Equation (20.51), we have



The enthalpy of formation of NaCl(s) is  $-411.153 \text{ kJ mol}^{-1}$  (11). Hence, we may write



To this calculation, we need to add the enthalpy change for the reaction



As the enthalpy of the dissolved sodium chloride in its standard state according to Henry's law is that of the infinitely dilute solution,  $\Delta H_{\text{m}}$  for the reaction in Equation (20.74) is

$$\Delta H_{\text{m}} = H_{\text{m}2}^\infty - H_{\text{m}2(\text{s})} = H_{\text{m}2}^\circ - H_{\text{m}2(\text{s})} \quad (20.75)$$

which, according to Equation (18.7), is  $-L_{\text{m}2(\text{s})}$ . The relative partial molar enthalpy of solid sodium chloride is  $-3.861 \text{ kJ mol}^{-1}$  (17). Thus, for the reaction in Equation (20.51)

$$\begin{aligned}\Delta G_{\text{m}}^\circ &= -393.188 \text{ kJ mol}^{-1} \\ \Delta H_{\text{m}}^\circ &= -407.292 \text{ kJ mol}^{-1}\end{aligned}\quad (20.76)$$

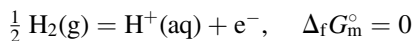
and

$$\Delta S_{\text{m}}^\circ = -47.31 \text{ J mol}^{-1} \text{K}^{-1}$$

### Entropy of Formation of Individual Ions

As in the case of Gibbs function changes, we also can divide the entropy change for a reaction [such as Equation (20.51)] into two parts and can assign one portion to each ion. As actual values of individual-ion entropies cannot be determined, we must establish some convention for apportioning the entropy among the constituent ions.

In treating the Gibbs functions for individual ions, we adopted the convention that  $\Delta_f G_m^\circ$  of the hydrogen ion equals zero for all temperatures; that is [Equation (20.44)],



We also have shown previously [Equation (7.49)] that

$$\left(\frac{\partial \Delta G}{\partial T}\right)_P = -\Delta S$$

If Equation (20.44) is valid at all temperatures, it follows that the entropy change in the formation of hydrogen ion from gaseous hydrogen must be zero; that is,

$$\frac{1}{2} \text{H}_2(\text{g}) = \text{H}^+(\text{aq}) + \text{e}^-, \quad \Delta_f S_m^\circ = -\left(\frac{\partial \Delta_f G_m^\circ}{\partial T}\right)_P = 0 \quad (20.77)$$

Therefore, a consistent convention would set the standard entropy of aqueous  $\text{H}^+$  ion equal to  $\frac{1}{2} S_{\text{H}_2(\text{g})}^\circ - S_e^\circ$  (18) or  $65.342 \text{ J mol}^{-1} \text{ K}^{-1} - S_e^\circ$  (11).

Historically, the usefulness of ionic entropies first was emphasized by Latimer and Buffington (19), who established the convention of setting the standard entropy of hydrogen ion equal to zero; that is,

$$S_{\text{m},\text{H}^+}^\circ \equiv 0 \quad (20.78)$$

Therefore, to maintain the validity of Equation (20.77), we should assign a value of  $65.342 \text{ J mol}^{-1} \text{ K}^{-1}$ ,  $\frac{1}{2} S_m^\circ(\text{H}_2)$ , to  $S_m^\circ$  for a mole of electrons. In practice, half-reactions are combined to calculate  $\Delta S_m^\circ$  for an overall reaction in which no net gain or loss of electrons occurs; hence, any value assumed for  $S_m^\circ$  of the electron will cancel out. We will use Equation (20.78) and the consequent value for  $S_m^\circ$  for the electron.

Having chosen a value for  $S_{\text{m},\text{H}^+}^\circ$ , we can proceed to obtain  $S_{\text{m},298\text{K}}^\circ$  for the  $\text{Cl}^-$  ion from any one of several reactions [for example, Equation (20.43)] for the formation of aqueous  $\text{H}^+$  and  $\text{Cl}^-$ . Using values of  $-131.386 \text{ kJ mol}^{-1}$  and  $-167.159 \text{ kJ mol}^{-1}$  for  $\Delta G_m^\circ$  and  $\Delta H_m^\circ$ , respectively (11), we can calculate  $-119.98 \text{ J mol}^{-1} \text{ K}^{-1}$  for  $\Delta S_m^\circ$  at 298.15 K. If we adopt the convention stated in Equation (20.78), and if  $S_{\text{m},298}^\circ$  for  $\text{Cl}_2(\text{g})$  is taken as  $223.066 \text{ J mol}^{-1} \text{ K}^{-1}$  and that for  $\text{H}_2(\text{g})$  is  $130.684 \text{ J mol}^{-1} \text{ K}^{-1}$ , it follows that for Reaction (20.43)

$$\begin{aligned} \Delta_f S_{\text{m},298\text{K}}^\circ &= S_{\text{m},\text{H}^+}^\circ + S_{\text{m},\text{Cl}^-}^\circ - \frac{1}{2} S_{\text{m},\text{H}_2}^\circ - \frac{1}{2} S_{\text{m},\text{Cl}_2}^\circ \\ &= -120.0 \text{ J mol}^{-1} \text{ K}^{-1} \end{aligned} \quad (20.79)$$

Hence

$$S_{\text{m},\text{Cl}^-}^\circ = 56.89 \text{ J mol}^{-1} \text{ K}^{-1} \quad (20.80)$$

$$\begin{aligned}\Delta_f S_{m,298\text{K}}^\circ &= S_{m,\text{Na}^+}^\circ + S_{m,\text{Cl}^-}^\circ - S_{m,\text{Na(s)}}^\circ - S_{m,\text{Cl}_2(\text{gas})}^\circ \\ &= -47.31 \text{ J mol}^{-1} \text{ K}^{-1}\end{aligned}\quad (20.81)$$

Having a value for  $S_{m,\text{Cl}^-}^\circ$ , we can proceed to obtain the entropy of formation for  $\text{Na}^+(\text{aq})$  from  $\Delta_f S_m^\circ$  for Reaction (20.51). Consequently, with  $S_{m,\text{Na(s)}}^\circ = 51.21 \text{ J mol}^{-1} \text{ K}^{-1}$  (11),

$$S_{m,\text{Na}^+}^\circ = 58.54 \text{ J mol}^{-1} \text{ K}^{-1} \quad (20.82)$$

By procedures analogous to those described in the preceding two examples, we can obtain entropies for many aqueous ions. A list of such values is assembled in Table 20.1.

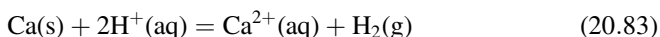
**TABLE 20.1. Entropies of Aqueous Ions at 298.15 K [11]**

Ion	$S_m^\circ/\text{J mol}^{-1} \text{ K}^{-1}$	Ion	$S_m^\circ/\text{J mol}^{-1} \text{ K}^{-1}$
$\text{H}^+$	(0.00)	$\text{ClO}^-$	42.0
$\text{Li}^+$	13.4	$\text{ClO}_2^-$	101.3
$\text{Na}^+$	59.0	$\text{ClO}_3^-$	162.3
$\text{K}^+$	102.5	$\text{ClO}_4^-$	182.0
$\text{Rb}^+$	121.50	$\text{BrO}_3^-$	161.71
$\text{Cs}^+$	133.05	$\text{IO}_3^-$	118.4
$\text{NH}_4^+$	113.4	$\text{HS}^-$	62.8
$\text{Ag}^+$	72.68	$\text{HSO}_3^-$	139.7
$\text{Ag}(\text{NH}_3)_2^+$	245.2	$\text{SO}_3^{2-}$	-29.0
$\text{Tl}^+$	125.5	$\text{HSO}_4^-$	131.8
$\text{Mg}^{2+}$	-138.1	$\text{SO}_4^{2-}$	20.1
$\text{Ca}^{2+}$	-53.1	$\text{NO}_2^-$	123.0
$\text{Sr}^{2+}$	-32.6	$\text{NO}_3^-$	146.4
$\text{Ba}^{2+}$	9.6	$\text{H}_2\text{PO}_4^-$	90.4
$\text{Fe}^{2+}$	-137.7	$\text{HPO}_4^{2-}$	-33.5
$\text{Cu}^{2+}$	-99.6	$\text{PO}_4^{3-}$	-222.0
$\text{Zn}^{2+}$	-112.1	$\text{HCO}_3^-$	91.2
$\text{Cd}^{2+}$	-73.2	$\text{CO}_3^{2-}$	-56.9
$\text{Hg}_2^{2+}$	84.5	$\text{C}_2\text{O}_4^{2-}$	45.6
$\text{Sn}^{2+}$	-17.0 <sup>a</sup>	$\text{CN}^-$	94.1
$\text{Pb}^{2+}$	10.5	$\text{MnO}_4^{2-}$	191.2
$\text{Al}^{3+}$	-321.7	$\text{H}_2\text{AsO}_4^-$	117.0
$\text{Fe}^{3+}$	-315.9	$\text{CrO}_4^{2-}$	50.21
$\text{OH}^-$	-10.75		
$\text{F}^-$	-13.8		
$\text{Cl}^-$	56.5		
$\text{Br}^-$	82.4		
$\text{I}^-$	111.3		

<sup>a</sup>In 3-*M*  $\text{NaClO}_4$ . For entropies of aqueous ions at high temperatures see C. M. Criss and J. W. Cobble, *J. Am. Chem. Soc.* **86**, 5385 (1964).

### Ion Entropies in Thermodynamic Calculations

With tables of ion entropies available, it is possible to estimate a Gibbs function change without the necessity of carrying out an experiment or seeking specific experimental data. For example, without seeking data for the potential of calcium electrodes, it is possible to calculate the calcium electrode potential or the Gibbs function change in the reaction



from the data in Table 20.1 plus a knowledge of  $\Delta H_m^\circ$  of this reaction. Thus,

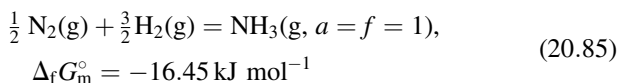
$$\begin{aligned} \Delta S_{m,298K}^\circ &= S_{m,\text{Ca}^{2+}}^\circ + S_{m,\text{H}_2}^\circ - S_{m,\text{Ca(s)}}^\circ - 2S_{m,\text{H}^+}^\circ \\ &= -53.1 + 130.684 - 41.42 - 0 = 36.1 \text{ J mol}^{-1} \text{ K}^{-1} \end{aligned} \quad (20.84)$$

As  $\Delta H_m^\circ$  is  $-542.83 \text{ kJ mol}^{-1}$  (11), we find a value of  $\Delta G_m^\circ$  of  $-542.07 \text{ kJ mol}^{-1}$ . Hence,  $\mathcal{E}^\circ$  for Reaction (20.83) is 2.8090 V.

### EXERCISES

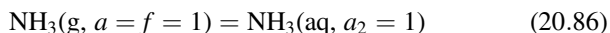
**20.1.** The Gibbs function for formation of  $\text{NH}_4^+(\text{aq})$  can be obtained from the following information:

a.  $\Delta_f G_m^\circ$  of  $\text{NH}_3(\text{g})$  is  $-16.45 \text{ kJ mol}^{-1}$  at 298.15 K. That is,



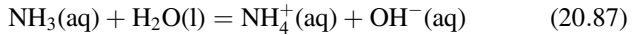
b. A graph of  $p/(m_2/m_2^\circ)$ , where  $p$  is the partial pressure of  $\text{NH}_3(\text{g})$  in equilibrium with the solution and  $m_2$  is the molality of undissociated ammonia dissolved in water, extrapolates to a limit of  $0.01764 \text{ atm (mol kg}^{-1})^{-1}$  as  $m_2$  approaches zero. If the fugacity is assumed to be equal to the partial pressure, show that the Henry's-law constant,  $k_2''$  [Equation (15.8)] is  $0.01764 \text{ atm}$ . For this calculation, the quantity of ammonia that is dissociated in solution is negligible (that is, the graph has a horizontal asymptote at relatively high values of  $m_2$ , where the fraction of  $\text{NH}_4^+$  ions is very small).

c. Show that  $\Delta G_{m,298K}^\circ$  must be  $-9.976 \text{ kJ mol}^{-1}$  for the reaction



Keep in mind that although  $a$  and  $a_2$  are both 1, they have not been defined on the basis of the same standard state.

d. The equilibrium constant for the reaction



can be taken as  $1.8 \times 10^{-5}$  and the standard Gibbs function of formation of  $\text{H}_2\text{O}(\text{l})$  at 298.15 K is  $-237.129 \text{ kJ mol}^{-1}$ . Show that  $\Delta_f G_{\text{m},298\text{K}}^\circ$  for  $\text{NH}_4^+ + \text{OH}^-$  ions is  $-236.4 \text{ kJ mol}^{-1}$ .

e. If  $\Delta_f G_{\text{m},298\text{K}}^\circ$  for  $\text{OH}^-$  is  $-157.244 \text{ kJ mol}^{-1}$ , show that the corresponding quantity for  $\text{NH}_4^+$  is  $-79.24 \text{ kJ mol}^{-1}$ .

20.2. Given the following information for  $\text{CO}_2$  and its aqueous solutions, and using standard sources of reference for any other necessary information, calculate the standard Gibbs function of formation at 298.15 K for the  $\text{CO}_3^{2-}$  ion. Henry's-law constant [see Equations (15.8) and (15.9)] for solubility in  $\text{H}_2\text{O} = 29.5$  for  $p$  in atmospheres and  $m_2$  in moles  $(\text{kg H}_2\text{O})^{-1}$ .

$$\text{Ionization constants of H}_2\text{CO}_3: \quad K_1 = 3.5 \times 10^{-7}$$

$$K_2 = 3.7 \times 10^{-11}$$

20.3. The solubility of pure solid glycine at  $25^\circ\text{C}$  in water is  $3.33 \text{ moles } (\text{kg H}_2\text{O})^{-1}$ . The activity coefficient of glycine in such a saturated solution is 0.729. Data for the relative partial molar enthalpies of glycine in aqueous solution are tabulated in Exercise 15 of Chapter 18. Given  $\Delta_f G_{\text{m}}^\circ$  and  $\Delta_f H_{\text{m}}^\circ$  for solid glycine, complete Table 20.2.

Correct answers can be found in an article by Gucker et al. [20].

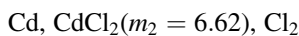
20.4. The solubility of  $\alpha$ -D-glucose in aqueous 80% ethanol at  $20^\circ\text{C}$  is  $20 \text{ g L}^{-1}$ , that of  $\beta$ -D-glucose,  $49 \text{ g L}^{-1}$  (21). If an excess of solid  $\alpha$ -D-glucose is allowed to remain in contact with its solution for sufficient time, some  $\beta$ -D-glucose is formed, and the total quantity of dissolved glucose increases to  $45 \text{ g L}^{-1}$ . If excess solid  $\beta$ -D-glucose remains in contact with its solution, some  $\alpha$ -D-glucose is formed in the solution, and the total concentration rises to a limit, which we will refer to as  $C_\beta$ .

a. Assuming that the activity of each sugar is proportional to its concentration and that neither substance has an appreciable effect on the chemical potential of the other, determine  $\Delta G_{\text{m}}^\circ$  for:

**TABLE 20.2. Thermodynamic Data for Glycine and its Aqueous Solutions**

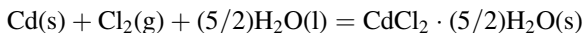
	Glycine(s)	Glycine(aq)
$\Delta_f G_{\text{m}}^\circ$	$-370.54 \text{ kJ mol}^{-1}$	
$\Delta_f H_{\text{m}}^\circ$	$-528.31 \text{ kJ mol}^{-1}$	
$\Delta_f S_{\text{m}}^\circ$		

- (i)  $\alpha$ -*D*-glucose(s) =  $\beta$ -*D*-glucose(s)  
 (ii)  $\alpha$ -*D*-glucose(s) =  $\alpha$ -*D*-glucose(solute)  
 (iii)  $\alpha$ -*D*-glucose(solute) =  $\beta$ -*D*-glucose(solute).  
 (iv)  $\beta$ -*D*-glucose(s) =  $\beta$ -*D*-glucose(solute).
- b. Compute the concentration  $C_\beta$ . Is such a solution stable? Explain.
- 20.5. The dissociation constant of acetic acid is  $1.754 \times 10^{-5}$ . Calculate the degree of dissociation of 0.01-molar acid in the presence of 0.01-molar NaCl. Use the Debye–Hückel limiting law to calculate the activity coefficients of the ions. Take the activity coefficient of the undissociated acid as unity. In your calculation neglect the concentration of  $H^+$  in comparison with the concentration of  $Na^+$ .
- 20.6. When  $\Delta G_m^\circ$  is calculated from an equilibrium constant  $K$ , what error would result at 25°C from an error of a factor of 2 in  $K$ ?
- 20.7. a. What will happen to the degree of dissociation of 0.02-molar acetic acid if NaCl is added to the solution? Explain.  
 b. What will happen to the degree of hydrolysis of 0.02-molar sodium acetate if NaCl is added? Explain.
- 20.8. Two forms of solid A exist. For the transition  $A' = A''$ ,  $\Delta G_m^\circ = -1000 \text{ J mol}^{-1}$ .  $A'$  and  $A''$  produce the same dissolved solute. Which is more soluble? Calculate the ratio of the solubilities of  $A'$  and  $A''$ .
- 20.9. Henry's law is obeyed by a solute in a certain temperature range. Prove that  $L_{m2}$ ,  $L_{m1}$ , and the integral heat of dilution are zero within this range. Do not assume that Henry's-law constant is independent of temperature; generally, it is not.
- 20.10. The average value of  $L_{m2}$  between 0°C and 25°C for NaCl in 0.01-molar solution is about  $188 \text{ J mol}^{-1}$ . According to the Debye–Hückel limiting law,  $\gamma_\pm$  of NaCl in this solution at 25°C is 0.89.  
 a. Calculate  $\gamma_\pm$  at 0°C from the thermodynamic relationship for the temperature coefficient of  $\ln \gamma_\pm$  [Equation (19.68)].  
 b. Calculate  $\gamma_\pm$  at 0°C from the Debye–Hückel limiting law at that temperature. Compare the result with that obtained in (a).
- 20.11. The activity coefficient of  $CdCl_2$  in 6.62-molal solution is 0.025. The potential of the cell



is 1.8111 V at 25°C. The 6.62-molal solution is a saturated one; it can exist in equilibrium with solid  $CdCl_2 \cdot (5/2)H_2O$  and  $H_2O$  vapor at a pressure of 16.5

mm Hg. Calculate  $\Delta G_m^\circ$  for the reaction



For the solutions of Exercises 12 through 18, the Debye–Hückel limiting law is sufficiently accurate, and the numbers in parentheses can be read as either molality or molarity at this level of approximation. The temperature to be used is 25°C.

**20.12.** Calculate the potential of the cell pair



**20.13.** Calculate the potential of the cell

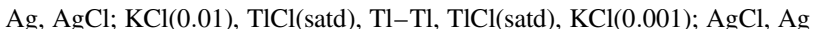


using the fact that the cell



has a potential of 0.46395 V.

**20.14.** Calculate the potential of the cell pair



**20.15.** MacInnes and Shedlovsky [5] have made conductance measurements that indicate that 0.02-molar acetic acid is 2.987% ionized. Assuming that the activity coefficient of the undissociated acid is 1:

- a. Compute the ionization constant of acetic acid.
- b. Using this constant, calculate the degree of dissociation of 0.01-molar acetic acid.

**20.16.** Two solutions contain only hydrochloric acid, acetic acid, and water. In the first solution the concentration of acetate ion is 0.0004 molar; in the second, it is 0.0001 molar. The total ionic strength in each solution is 0.01 molar. Compute the ratio of the activities of acetic acid in the two solutions.

**20.17.** Two solutions contain only sodium chloride, acetic acid, and water. In the first solution, the concentration of acetate ion is 0.0004 molar; in the second, it is 0.0001 molar. The total ionic strength of each solution is 0.01. Compute the ratio of the activities of acetic acid in the two solutions. What can be said about the relative partial vapor pressures of the monomeric form of acetic acid above the solutions? Of acetic acid dimer?

- 20.18.** The solubility in 0.0005-molar  $\text{KNO}_3$  of hexaamminecobalt(III) hexacyanoferrate(III),  $[\text{Co}(\text{NH}_3)_6][\text{Fe}(\text{CN})_6]$ , was found by La Mer et al. [22] to be  $3.251 \times 10^{-5} \text{ mol L}^{-1}$ .
- In what concentration of  $\text{MgSO}_4$  is its solubility the same?
  - What is its solubility in pure water? As the ionic strength is not known, the problem can be solved by a method of successive approximations (or by a graphical method).
  - Calculate its solubility in 0.0025-molar  $\text{MgSO}_4$ . How much error is introduced by neglecting the contribution of the complex salt itself to the ionic strength?
  - The total molarity ( $C$  of the cobalt complex plus  $C$  of  $\text{NaCl}$ ) of a solution containing  $\text{NaCl}$  and saturated with the complex salt is 0.0049. Calculate the molarities of each of the solutes.
- 20.19.** Strong et al. [8] have determined the ionization constant of benzoic acid in  $\text{H}_2\text{O}$  as a function of temperature by conductance methods. Their data are listed in Table 20.3, with the  $pK_a$  based on a hypothetical standard state of  $1 \text{ mol dm}^{-3}$ . Temperature was controlled to  $\pm 0.002^\circ\text{C}$ .
- To change  $pK_a$  to a hypothetical standard state of  $1 \text{ mol kg}^{-1}$ , it is necessary to add to each value  $\log [\rho_{\text{H}_2\text{O}}/\text{g dm}^{-3}]$ , where  $\rho = (999.83952 + 16.945176t - 7.9870401 \times 10^{-3}t^2 - 46.170461 \times 10^{-6}t^3 + 105.56302 \times 10^{-9}t^4 - 280.54243 \times 10^{-12}t^5)/(1 + 0.01687985t)$ . Calculate  $pK_a$  on the molal scale, and calculate  $\Delta G_m^\circ$ , and  $\Delta Y_m^\circ$  for each temperature. Plot  $\log K$ ,  $\Delta G_m^\circ$ , and  $\Delta Y_m^\circ$  as a function of temperature. Use the method of numeric

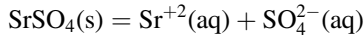
**TABLE 20.3. Ionization Constants of Benzoic Acid as a Function of Temperature**

$t/^\circ\text{C}$	$pK_a$
5	4.2245
10	4.2148
15	4.2076
20	4.2034
25	4.1998
30	4.2013
35	4.2061
40	4.2115
45	4.2190
50	4.2287
55	4.2400
60	4.2525
65	4.2665
70	4.2821
75	4.2991
80	4.3170



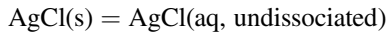
differentiation described in Appendix A to obtain values of  $\Delta H_m^\circ$ ,  $\Delta C_{pm}^\circ$ , and  $\Delta S_m^\circ$ . Also use the difference table method suggested by Ives and Mosley [23], and compare the results with those obtained with numeric differentiation.

**20.20.** The solubility of  $\text{SrSO}_4$  in water is 0.00087 molar. Calculate  $\Delta G_m^\circ$  for



**20.21.** A saturated solution of  $\text{AgCl}$  in water at  $25^\circ\text{C}$  contains  $\text{Ag}^+$  and  $\text{Cl}^-$ , each at the concentration  $1.338 \times 10^{-5}$  mole  $(\text{kg H}_2\text{O})^{-1}$ . It also contains dissolved undissociated  $\text{AgCl}$ , whose dissociation constant is  $0.49 \times 10^{-3}$ .

- Determine the mean activity coefficient of the  $\text{Ag}^+$  and  $\text{Cl}^-$  ions from the Debye–Hückel limiting law.
- Calculate the concentration of undissociated  $\text{AgCl}$ . Assume that the activity coefficient of undissociated  $\text{AgCl}$  is equal to 1.
- Calculate  $\Delta G_m^\circ$  for the reaction



- Compute the mean *stoichiometric* activity coefficient of the  $\text{Ag}^+$  and  $\text{Cl}^-$  ions, which is equal to  $a/(m_s/m^\circ)$ . Why must it be less than the activity coefficient calculated from the Debye–Hückel theory?

## REFERENCES

- T. F. Young and A. C. Jones, *Ann. Rev. Phys. Chem.* **3**, 275 (1952).
- H. S. Harned and R. W. Ehlers, *J. Am. Chem. Soc.* **54**, 1350 (1932); R. E. Mesmer, W. L. Marshall, D. A. Palmer, J. M. Simonson, and H. F. Holmes, *J. Solution Chem.* **17**, 699 (1988).
- D. A. MacInnes and T. Shedlovsky, *J. Am. Chem. Soc.* **54**, 1429 (1932); L. E. Strong, T. Kinney, and P. Fischer, *J. Solution Chemistry* **8**, 329 (1979).
- H. von Halban and G. Kortum, *Z. Physik. Chem.* **170**, 212, 351 (1934); T. F. Young, C. R. Singleterry, and I. M. Klotz, *J. Phys. Chem.* **82**, 671 (1978); T. F. Young, L. F. Maranville, and H. M. Smith, eds., *The Structure of Electrolytic Solutions*, John Wiley & Sons, New York, 1959, p. 42.
- D. A. MacInnes and T. Shedlovsky, *J. Am. Chem. Soc.* **54**, 1429 (1932).
- See M. Randall and C. F. Failey, *Chem. Rev.* **4**, 291 (1927).
- R. E. Mesmer, W. L. Marshall, D. A. Palmer, J. M. Simonson, and H. F. Holmes, *J. Solution Chem.* **17**, 699 (1988).
- L. E. Strong, T. Kinney, and P. Fischer, *J. Solution Chem.* **8**, 329 (1979); R. M. Fuoss, *J. Phys. Chem.* **80**, 2091 (1976).
- S. J. Bates and H. D. Kirschman, *J. Am. Chem. Soc.* **41**, 1991 (1919); see also G. N. Lewis and M. Randall, *Thermodynamics*, McGraw-Hill, New York, 1923, p. 330.

10. H. S. Harned and B. B. Owen, *The Physical Chemistry of Electrolytic Solutions*, 3rd ed., Reinhold, New York, 1958, p. 466.
11. D. D. Wagman, et al., The NBS tables of chemical thermodynamic properties, *J. Phys. Chem. Ref. Data* **11**, Supplement No. 2, 1982.
12. E. A. Guggenheim, *J. Phys. Chem.* **33**, 842 (1929); **34**, 1541 (1930).
13. H. Borsook and H. D. Schott, *J. Biol. Chem.* **92**, 535 (1931).
14. For a general review, see T. F. Young, L. F. Maranville, and H. M. Smith, Raman spectral investigations of ionic equilibria in solutions of strong electrolytes, in *The Structure of Electrolytic Solutions*, W. J. Hamer ed., Wiley, New York, 1959, pp. 35–63.
15. G. Scatchard, S. S. Prentice, and P. T. Jones, *J. Am. Chem. Soc.* **54**, 2690 (1932).
16. G. J. F. Macdonald, *Am. J. Science* **251**, 884 (1953); See also R. Kern and A. Weisbrod, *Thermodynamics for Geologists*, Freeman, Cooper and Co., San Francisco, CA, 1967, p. 277; K. S. Pitzer, J. Pieper, and R. H. Busey, *J. Phys. Chem. Ref. Data*, **13**, 1 (1984).
17. T. F. Young and O. G. Vogel, *J. Am. Chem. Soc.* **54**, 3030 (1932).
18. I. M. Klotz, *Chemical Thermodynamics*, 1st ed., Prentice-Hall, New York, 1950, pp. 353–355.
19. W. M. Latimer and R. M. Buffington, *J. Am. Chem. Soc.* **48**, 2297 (1926).
20. F. T. Gucker, Jr., H. B. Pickard, and W. L. Ford, *J. Am. Chem. Soc.* **62**, 2698 (1940).
21. C. S. Hudson and E. Yanovsky, *J. Am. Chem. Soc.* **39**, 1013 (1917).
22. V. K. La Mer, C. V. King, and C. F. Mason, *J. Am. Chem. Soc.* **49**, 363 (1927).
23. D. J. G. Ives and P. G. N. Mosley, *J. Chem. Soc. Faraday Trans. I* **72**, 1132 (1976).



## CHAPTER 21

---

# SYSTEMS SUBJECT TO A GRAVITATIONAL OR A CENTRIFUGAL FIELD

---

In most circumstances of interest to chemists, the dominant experimental variables are temperature, pressure, and composition, and our attention has been concentrated on the dependence of a transformation on these factors. On some occasions, however, a transformation takes place in a field: gravitational, electrical, or magnetic; chemists who work with macromolecules frequently use a centrifugal field in their work. It behooves us, therefore, to see how we can approach such problems. As a gravitational field is the most familiar in common experience, we shall focus initially on some representative problems in this area.

### 21.1 DEPENDENCE OF THE GIBBS FUNCTION ON EXTERNAL FIELD

In our exposition of the properties of the Gibbs function  $G$  (Chapter 7), we examined systems with constraints on them in addition to the ambient pressure. We found that changes in Gibbs function are related to the maximum work obtainable from an isothermal transformation. In particular, for a reversible transformation at constant pressure and temperature [Equation (7.79)],

$$dG_{T,P} = DW_{\text{net}}$$

where  $DW$  is the net useful (non- $PV$ ) reversible work associated with the change in Gibbs function.

Of course, the equality in Equation (7.79) is symmetric; that is, the equation may be read in the mirror-image direction: If we perform reversible (non- $PV$ ) work  $DW_{\text{net}}$  on a system at constant pressure and temperature, we increase its Gibbs function by the amount  $dG_{T,P}$ . For example, if we reversibly change the position  $x$  of a body in the gravitational field of the earth [Fig. 21.1(a)], we perform an amount of work given by

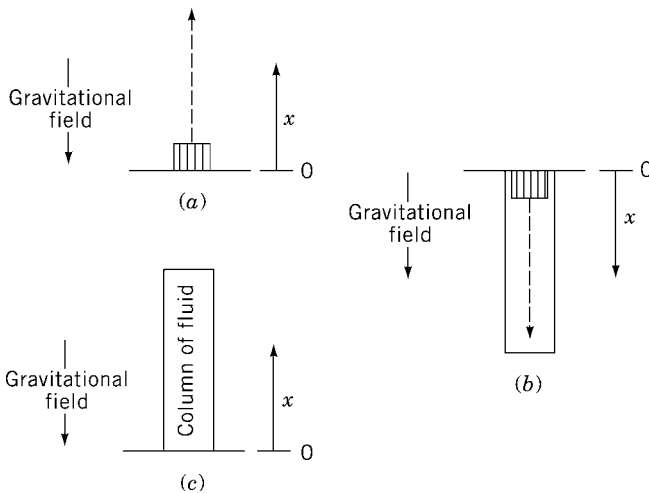
$$DW_{\text{net}} = mgdx \tag{21.1}$$

where  $m$  is the mass of the body,  $g$  is the gravitational acceleration, and  $x$  is positive in the upward direction. It follows then from Equation (7.79) that

$$\left(\frac{\partial G}{\partial x}\right)_{T,P} = mg = \text{force exerted on body that moves it against gravitational field} \tag{21.2}$$

If we consider lowering a body down a shaft [Fig. 21.1(b)] it is convenient to change our convention regarding the positive direction of  $x$  to downward. Hence,

$$\left(\frac{\partial G}{\partial x}\right)_{T,P} = -mg \tag{21.3}$$



**Figure 21.1.** Reversible processes in a gravitational field.

More generally, for constraints other than gravity, we can also state that

$$DW_{\text{net in field}} = (\text{force exerted against field}) dx \equiv F dx \quad (21.4)$$

Consequently, it follows that

$$\left(\frac{\partial G}{\partial x}\right)_{T,P} = \text{force exerted against field} \equiv F \quad (21.5)$$

For a system of constant composition in which fields are absent, we found in Chapter 7 that because the Gibbs function  $G$  is a function of pressure and temperature,

$$G = f(T, P)$$

we can write for the total differential [Equation (7.42)]

$$dG = \left(\frac{\partial G}{\partial T}\right)_P dT + \left(\frac{\partial G}{\partial P}\right)_T dP$$

Subsequently, when we examined systems in which composition, as well as  $T$  and  $P$ , can be varied (but fields are still absent or constant), we found [Equation (9.2)] that

$$G = f(T, P, n_1, n_2, \dots, n_i)$$

where  $n_1, n_2, \dots$  are the moles of the respective components. So the total differential now becomes [Equation (9.3)]

$$dG = \left(\frac{\partial G}{\partial T}\right)_{P,n_i} dT + \left(\frac{\partial G}{\partial P}\right)_{T,n_i} dP + \sum \left(\frac{\partial G}{\partial n_i}\right)_{T,P,n_j} dn_i$$

Now let us remove the constraint of a fixed field. To be concrete, let us move some unit of material from one position in the gravitational field of the earth to another. Under these circumstances, the Gibbs function  $G$  also depends on  $x$ , the position in the field, so we may write for the most general circumstances

$$G = f(T, P, n_1, n_2, \dots, n_i, x) \quad (21.6)$$

Consequently it follows that the total differential should be expressed as

$$dG = \left(\frac{\partial G}{\partial T}\right)_{P,n_i,x} dT + \left(\frac{\partial G}{\partial P}\right)_{T,n_i,x} dP + \sum \left(\frac{\partial G}{\partial n_i}\right)_{T,P,n_j,x} dn_i + \left(\frac{\partial G}{\partial x}\right)_{T,P,n_j} dx \quad (21.7)$$

and, from Equations (9.4)–(9.6), and (21.2)

$$dG = -SdT + VdP + \sum \mu_i dn_i + mgdx \quad (21.8)$$

## 21.2 SYSTEM IN A GRAVITATIONAL FIELD

Let us now analyze some specific systems. First, we examine a column of pure fluid perpendicular to the surface of the earth [Fig. 21.1(c)] and at equilibrium. In this case, it can be shown by the following argument that the pressure within the fluid varies with position in the gravitational field.

The column of pure fluid [Fig. 21.1(c)] is at a constant temperature, and the external pressure on it is constant. Thus, for the column of fluid

$$dG = 0 \quad (21.9)$$

for any transfer of fluid from one level to another.

Let us now analyze the contributions to  $dG$  if we take one mole of the pure fluid in the column at position  $x$  and move it to the position  $x + dx$ . At each level within the column, the pressure is different (as the weight of fluid above it is different), although it remains fixed at each level. Hence, as the temperature and the composition remain fixed, when a unit of pure fluid is being moved from one position to another, Equation (21.8) can be written as

$$dG = dG_m = V_m dP + Mgdx = 0 \quad (21.10)$$

where  $G_m$  and  $V_m$  denote values of the respective properties per mole and  $M$  is the molar mass. From this equation, we conclude that

$$\frac{\partial P}{\partial x} = -\frac{M}{V_m} g = -\rho g \quad (21.11)$$

where  $\rho$  is the density of the fluid. Thus, the pressure in the fluid is a function of  $x$ , and for the column rising from the surface of the earth [Fig. 21.1(c)], the pressure decreases as the distance  $x$  above the surface increases.

If the pure fluid were in the shaft extending below the surface [Fig. 21.1(b)], our analysis would correspond in every detail to that in the column above the surface except that the negative sign in Equation (21.11) would be replaced by a positive sign, because  $x$  is positive in the direction of the gravitational field. Thus, the pressure within the fluid would *increase* as the depth  $x$  down the shaft increases.

Let us examine now a column of a *solution* in the shaft of Figure 21.1(b). For simplicity, we shall assume only one dissolved solute is in a single-component solvent. If equilibrium has been attained, we find that the molality  $m$  of solute varies with the depth, and we can derive an analytic expression for this dependence of molality on depth.

Consider the transfer of one mole of solute from one position  $x$  in the column at equilibrium to another position  $x + dx$ . The transfer of the solute, in a column of very large cross section, does not change the molality at any position. The fluid in the shaft is at equilibrium, its temperature is invariant, and the external pressure on it is fixed; hence,  $dG = 0$ . A mole of solute in solution has a molar Gibbs function  $G_{m2}$ . If the solute is moved from one position  $x$  to another,  $x + dx$ , it could undergo a change in Gibbs function  $dG_{m2}$  resulting from the difference in pressure in the fluid, because of the change of position in the gravitational field, and as a result of any change in molality of solute at different levels. As, in our thought experiment, this transposition is the only change being made in the system, we can write<sup>1</sup> in place of Equation (21.7), using  $\ln m$  in place of  $n_i$ ,

$$\begin{aligned} dG &= dG_{m2} = \left( \frac{\partial G_{m2}}{\partial \ln m} \right)_{P,x} d \ln m + \left( \frac{\partial G_{m2}}{\partial P} \right)_{\ln m,x} dP + \left( \frac{\partial G_{m2}}{\partial x} \right)_{\ln m,P} dx \\ &= 0 \end{aligned} \quad (21.12)$$

From Equation (15.11), we can obtain the following relation:

$$G_{m2} = RT \ln(m/m^\circ) + G^\circ_{m2}; \quad \left( \frac{\partial G_{m2}}{\partial \ln m} \right)_{P,x} = RT \quad (21.13)$$

From an equation analogous to Equation (9.25), it follows (see Exercise 4 of Chapter 9) that

$$\left( \frac{\partial G_{m2}}{\partial P} \right)_{\ln m,x} = V_{m2} = M_2 v_2 \quad (21.14)$$

where  $V_{m2}$  is the partial molar volume of the solute,  $v_2$  is the partial specific volume of the solute, and  $M_2$  is its molar mass. The dependence of Gibbs function  $G$  on the gravitational field is expressed in Equation (21.3), which can be converted to

$$\frac{\partial G_{m2}}{\partial x} = -M_2 g \quad (2.15)$$

<sup>1</sup>In the absence of a field,  $G_m$  and  $\mu$  are identical. However, in the presence of a gravitational (or other) field, that identity no longer is valid because of historical reasons. As defined by Gibbs (J. W. Gibbs, *The Collected Works of J. Willard Gibbs*, Vol. 1, Longmans, Green and Co., New York, 1928, pp. 144–150), the chemical potential  $\mu$  is not a function of position  $x$  in a field. On the other hand, as used by G. N. Lewis (G. N. Lewis and M. Randall, *Thermodynamics*, McGraw-Hill, New York, 1923, pp. 242–244), the partial molar Gibbs function  $G_m$  includes the energy associated with position  $x$  in a field. For this reason we have expressed our derivations in terms of  $G_m$ . In a gravitational field (over distances for which  $g$  is essentially constant),  $G_m$  and  $\mu$  are related by the equation  $G_m = \mu + Mgx$ . Some thermodynamicists define a “total chemical potential”  $\mu_{\text{total}}$  or “gravitochemical potential” as the sum of  $\mu + Mgx$ ; hence, they are essentially using  $G_m$ .



because  $M_2$  and  $g$  are constants in the situation being analyzed. Recognizing that at equilibrium  $dG = 0$ , and substituting Equations (21.13) to (21.15) into Equation (21.12), we find [see Equation (21.11)]

$$\begin{aligned} RT \, d \ln m &= M_2 g dx - M_2 v_2 dP \\ &= M_2 g dx - M_2 v_2 \rho g dx \end{aligned} \quad (2.16)$$

If we integrate Equation (21.16) from  $x = 0$  to  $x = d$ , the result is

$$RT \ln \frac{m_{\text{at depth } d}}{m_{\text{at surface}}} = M_2 g (1 - v_2 \rho) d \quad (21.17)$$

where  $d$  is the depth below the surface.

Thus, whether an increase or decrease in molality occurs at depth  $d$ , in comparison with the surface, is determined by the factor  $(1 - v_2 \rho)$ . If  $v_2 \rho > 1$ , the molality of solute will decrease with increasing depth. On the other hand, if  $v_2 \rho < 1$ , the molality of solute will increase with increasing depth.

Let us illustrate this phenomenon with a practical example, the variation of oxygen and of nitrogen equilibrium solubilities with depth in the ocean [1]. For seawater, the density  $\rho$  depends on temperature and salinity, and it could vary from 1.025 to 1.035 g cm<sup>-3</sup>. For dissolved oxygen,  $v_2 = 0.97 \text{ cm}^3 \text{ g}^{-1}$  in seawater at a water temperature near 25°C. If  $d$  is expressed in meters, then at the lower limit of the water density, Equation (21.17) becomes

$$\log_{10} \frac{m_d}{m_{\text{surface}}} = 3.2 \times 10^{-7} d \quad (21.18)$$

Thus, for example, at a depth of 1000 m, and a density of 1.025 g cm<sup>-3</sup>, the solubility of oxygen is 1.0007 times the solubility at the surface. If the density of the seawater is as high as 1.035, then the solubility of oxygen at a depth of 1000 m is 1/1.007 times the solubility at the surface, assuming that  $v_2$  is 0.97 cm<sup>3</sup> g<sup>-1</sup>.

On the other hand, the situation with nitrogen is markedly different. Here, variations in salinity and temperature have little effect on the factor  $(1 - v_2 \rho)$  because the  $v_2$  of nitrogen, 1.43 cm<sup>3</sup> g<sup>-1</sup>, is relatively so large. Thus, for nitrogen, Equation (21.17) becomes

$$RT \ln \frac{m_d}{m_{\text{surface}}} = -2.4 \times 10^{-5} d \quad (21.19)$$

At a depth of 1000 m, the solubility of nitrogen decreases by 5–6%. In contrast to oxygen, the (equilibrium) solubility of nitrogen always decreases progressively with depth.

**21.3 SYSTEM IN A CENTRIFUGAL FIELD**

Near the surface of the earth, the gravitational acceleration  $g$  is essentially constant. For contrast, let us turn our attention next to a centrifugal field, where the acceleration is very sensitive to the distance from the center of rotation.

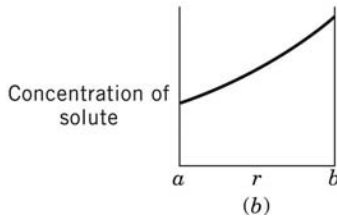
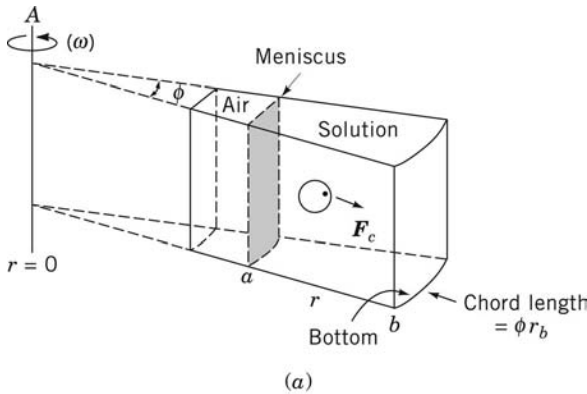
The centrifugal force  $F_c$  at a distance  $r$  from the axis of rotation (Fig. 21.2) is

$$F_c = m\omega^2 r \tag{21.20}$$

where  $m$  is the mass of the entity being centrifuged and  $\omega$  is the angular velocity. Thus, by an analysis similar to that presented for Equation (21.5), we find that

$$\left(\frac{\partial G}{\partial r}\right)_{P,T,n_i} = -m\omega^2 r \tag{21.21}$$

because  $m$  and  $\omega$  are constant. This relation is analogous to that in the gravitational field, with the angular acceleration  $\omega^2 r$  replacing the gravitational acceleration  $g$ .



**Figure 21.2.** (a) Schematic diagram of a sedimentation apparatus for determination of molecular mass of a solute molecule. The sector-shaped container is actually mounted in a rotor that spins about an axis of rotation  $A$  at an angular velocity  $\omega$ . The centrifugal field,  $F_c$  at any point is directed along the axis  $r$  in the direction of increasing  $r$ . At any position  $r$ , the chord length is  $\phi r$ , which increases with increasing  $r$ . The position of the liquid meniscus is indicated by  $a$ . (b) Concentration distribution of solute in cell at sedimentation equilibrium.

The negative sign on the right-hand side occurs because the Gibbs function decreases as  $r$  increases; that is, work would have to be performed on the sedimenting particle to bring it back from an axial position at large  $r$  to a position at small  $r$ .

If we now examine a cell (Fig. 21.2) containing a pure liquid (rather than a solution as shown), then again (as in the case of a gravitational field) we can show that the pressure in the pure fluid varies with position in the centrifugal field. Starting with Equation (21.8) we obtain

$$V_m dP - M\omega^2 r dr = 0 \quad (21.22)$$

in place of Equation (21.10) for the gravitational field, where  $V_m$  is the molar volume of the pure liquid. Thus, we conclude that

$$\frac{\partial P}{\partial r} = \frac{M}{V_m} \omega^2 r = \rho \omega^2 r \quad (21.23)$$

Therefore, the ambient pressure within the fluid in the cell in Figure 21.2 increases with increasing distance from the axis of rotation.

Finally, we consider the behavior of a solute in a solution in the cell subjected to the centrifugal field. At a suitable angular velocity, the tendency of the solute to sediment toward the bottom of the cell is countered by its tendency to diffuse backward toward the meniscus, because the concentration increases with increasing  $r$ , as indicated in Figure 21.2(b). At some time, a sedimentation equilibrium is attained. A typical equilibrium concentration distribution is depicted in Figure 21.2(b). Our aim is to find a quantitative analytical expression for this curve.

We consider a transfer at constant temperature of an infinitesimal amount of any single solute  $i$  from a position  $r$  in the cell in the centrifugal field to a second position  $r + dr$ . For this transfer at equilibrium, at constant  $T$  and external  $P$ ,  $dG = 0$ , so we write in place of Equation (21.12),

$$\begin{aligned} 0 = dG_{mi} = & \left( \frac{\partial G_{mi}}{\partial P} \right)_{c_i, c_k, r} dP + \left( \frac{\partial G_{mi}}{\partial c_i} \right)_{P, c_k, r} dc_i \\ & + \sum_{ki} \left( \frac{\partial G_{mi}}{\partial c_k} \right)_{P, c_i, r} dc_k + \left( \frac{\partial G_{mi}}{\partial r} \right)_{P, c_i, c_k} dr \end{aligned} \quad (21.24)$$

We distinguish between  $c_i$ , the concentration of solute whose distribution we are focusing on, and the  $c_k$ 's, the concentrations of other solutes, because this type of multicomponent system is of frequent practical interest. Since the development by Svedberg [2], the ultracentrifuge has been used widely to determine the molecular weight of a macromolecule from its concentration distribution at equilibrium. The large molecule, natural or synthetic, which may be designated by  $i$ , is dissolved frequently in an aqueous solution containing other solute species  $k$  to buffer the solution or to provide an appropriate ionic strength.

For the individual terms and factors on the right-hand side of Equation (21.24), we may insert the following substitutions:

$$\frac{\partial G_{mi}}{\partial P} = V_{mi} = M_i v_i \quad (21.25)$$

where  $v_i$  is the partial specific volume of the solute;

$$dP = \rho \omega^2 r dr \quad (21.26)$$

$$G_{mi} = RT \ln a_i + G_{mi}^\circ \quad (21.27)$$

$$\frac{\partial G_{mi}}{\partial c_i} = \left( \frac{\partial \ln a_i}{\partial c_i} \right) = RT \left[ \frac{\partial \ln c_i}{\partial c_i} + \frac{\partial \ln \gamma_i}{\partial c_i} \right] \quad (21.28)$$

$$\left( \frac{\partial G_{m,i}}{\partial c_k} \right)_{c_i} = RT \left( \frac{\partial \ln a_i}{\partial c_k} \right) = RT \left( \frac{\partial \ln \gamma_i}{\partial c_k} \right) \quad (21.29)$$

$$\frac{\partial G_{mi}}{\partial r} = -M_i \omega^2 r \quad (21.30)$$

Although we shall carry along the term in Equation (21.28) for the variation of  $\ln \gamma_i$  with  $c_i$ —for in practice the macromolecule concentration may cover a wide range from meniscus to bottom of the cell (Fig. 21.2)—we shall assume that the change in  $\ln \gamma_i$  of the macromolecule with change in concentration of other solutes  $c_k$  in the solution is negligible to a good approximation. Within these specifications, Equation (21.24) can be reduced to

$$0 = M_i v_i \rho \omega^2 r dr + RT \left[ \frac{1}{c_i} + \left( \frac{\partial \ln \gamma_i}{\partial c_i} \right) \right] dc_i - M_i \omega^2 r dr \quad (21.31)$$

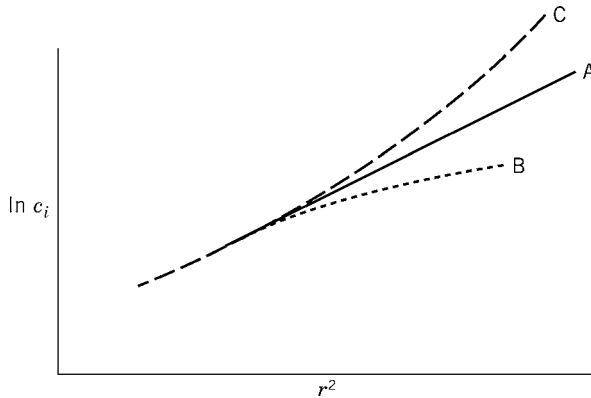
which in turn can be converted into

$$\frac{1}{r} \frac{1}{c_i} \left( \frac{\partial c_i}{\partial r} \right) = \frac{\omega^2}{RT} \frac{M_i (1 - v_i \rho)}{\left[ 1 + c_i \left( \frac{\partial \ln \gamma_i}{\partial c_i} \right) \right]} \quad (21.32)$$

An alternative form is

$$\left[ \frac{\partial \ln c_i}{\partial (r^2)} \right] = \frac{\omega^2}{2RT} \frac{M_i (1 - v_i \rho)}{\left[ 1 + c_i \left( \frac{\partial \ln \gamma_i}{\partial c_i} \right) \right]} \quad (21.33)$$

This equation suggests that a convenient graphical representation of the concentration distribution of species  $i$  would be one plotting  $\ln c_i$  versus  $r^2$ . Three representative possible curves are illustrated in Figure 21.3.



**Figure 21.3.** Concentration distribution of solute in solution at sedimentation equilibrium. Curve A represents ideal behavior of a monodisperse solute; curve B represents nonideality; and curve C represents a polydisperse system.

If the solute  $i$  is monodisperse—that is, if no dissociation or aggregation of the (macro)molecules occurs and each one has exactly the same molecular weight at every position in the cell—then  $M_i$  is the same for all macromolecular species in the solution. If, furthermore, these solute molecules do not interact with each other—that is, if they behave ideally—the term  $\partial \ln \gamma_i / \partial c_i = 0$ . Under these circumstances,  $\ln c_i$  varies linearly with  $r^2$ , as shown in line A of Figure 21.3. If the molecular weight of species  $i$  is unknown, it can be determined from the slope of line A, because Equation (21.33) becomes

$$\left[ \frac{\partial \ln c_i}{\partial (r^2)} \right] = \frac{\omega^2}{2RT} M_i (1 - v_i \rho) \quad (21.34)$$

Equilibrium ultracentrifugation has played a crucial role in establishing the molecular weights of protein molecules on an *ab initio* basis [3,4], that is, without requiring calibration with macromolecules of known molecular weight.

Should the macromolecules interact with each other, then  $\partial \ln \gamma_i / \partial c_i$  does not vanish. In actual experience, its value is almost always positive, largely because of excluded volume effects. Then,  $c_i [\partial \ln \gamma_i / \partial c_i]$  will then increase in magnitude as  $c_i$  increases and  $r$  decreases. Thus, the downward curvature shown in curve B of Figure 21.3 is typical of nonideal behavior.

It is also possible to observe upward curvature in a plot of  $\ln c_i$  versus  $r^2$ , as in curve C of Figure 21.3. This curvature occurs when the macromolecules are polydisperse, that is, when they possess a range of molecular weights. Common sense tells us, in this case correctly, that the heavier species in the class  $i$  will congregate toward the bottom of the cell. As the slope depends on  $M_i$ , curve C will become steeper as we move toward the bottom of the cell, where  $r$  is greater.

A mathematical analysis of equilibrium behavior in a polydisperse system leads to the conclusion that from the slope at any point on curve C, we can obtain a weight average molecular weight at that local concentration of solute  $i$ . Several software programs are available for carrying out the necessary calculations [5].

## EXERCISES

- 21.1.** Suppose a shaft [Fig. 21.1(b)] is filled with a column of an ideal gas at a uniform temperature  $T$ . Show that the variation of pressure  $P$  with depth  $d$  from the top of the column is given by the equation

$$P = P_0 e^{(Mg/RT)d}$$

where  $P_0$  is the pressure at the surface (that is, when  $d = 0$ ).

- 21.2.** The partial specific volume  $v_2$  for hydrogen gas dissolved in water is exceptionally large:  $13.0 \text{ mL gm}^{-1}$ . Find an equation for  $m_d/m_{\text{surface}}$  for dissolved  $\text{H}_2$ .
- 21.3.** In one of his experiments, Perrin [6] counted a total of 13,000 particles of gamboge and found average concentrations proportional to the numbers listed in Table 21.1 at the given heights ( $h$ ) above the bottom of the vessel. The experiment was carried out at 298 K, and the density of the particles was  $0.2067 \text{ kg dm}^{-3}$  greater than that of the water in which they were suspended. The mean radius of the particles was  $2.12 \times 10^{-7} \text{ m}$ . Calculate Avogadro's constant from these data.

**TABLE 21.1. Variation of Concentration with Height**

$h/10^{-6} \text{ m}$	Relative Concentration
5	100
35	47
65	22.6
95	12

**TABLE 21.2. Variation of Concentration with Radius**

$x/10^{-3} \text{ m}$	$c/(\text{g dm}^{-3})$
49.0	1.30
49.5	1.46
50.0	1.64
50.5	1.84
51.0	2.06
51.5	2.31

**21.4.** Pederson [7], a colleague of Svedberg's, studied the sedimentation equilibrium of lactoglobulin, a protein from milk, in the analytical ultracentrifuge. By graphical integration of the concentration gradient curve obtained with a Schlieren optical system, he calculated the concentration of protein  $c$  as a function of position in the cell (see Table 21.2). The partial specific volume of the protein was found to be  $0.7514 \text{ dm}^3 \text{ kg}^{-1}$ , and the density of the solution was  $1.034 \text{ kg dm}^{-3}$ . The rotor was turning at a rate of 182.8 rps. Calculate the molar mass.

## REFERENCES

1. I. M. Klotz, *Limnol. Oceanography* **8**, 149–151 (1963).
2. T. Svedberg and K. O. Pederson, *The Ultracentrifuge*, Oxford University Press, Oxford, U.K., 1940.
3. H. K. Schachman, *Ultracentrifugation in Biochemistry*, Academic Press New York, 1959.
4. H. Kim, R. C. Deonier, and J. W. Williams, *Chem. Rev.* **77**, 659 (1977).
5. J. Lebowitz, M. S. Lewis, and P. Schuck, *Protein Science* **11**, 2067–2069 (2002).
6. J. B. Perrin, *Ann. Chim. Phys.* **18**, 55–63 (1909).
7. K. O. Pederson, *Biochem. J.* **30**, 967 (1936).

## CHAPTER 22

---

# ESTIMATION OF THERMODYNAMIC QUANTITIES

---

In this chapter we shall review some empirical and theoretical methods of estimation of thermodynamic quantities associated with chemical transformations.

### 22.1 EMPIRICAL METHODS

Precise thermodynamic data are available for relatively few compounds. However, in many situations, it is desirable to have some idea of the feasibility or impossibility of a given chemical transformation even though the necessary thermodynamic data are not available. Several groups of investigators [1] have proposed empirical methods of correlation that allow us to estimate the thermodynamic properties required to calculate Gibbs functions and equilibrium constants. All of these methods are based on the assumption that a given thermodynamic property, such as entropy, of an organic substance can be resolved into contributions from each of the constituent groups in the molecule. With tables of such group contributions assembled from available experimental data, we can estimate the thermodynamic properties of any molecule by adding the contributions of the constituent groups. Additional corrections can be made for the effect of neighboring groups.

Generally, several alternative methods of choosing the groups exist into which a specified molecule is resolved. In the Anderson–Beyer–Watson–Yoneda approach, the thermodynamic properties in *the ideal gaseous state* are estimated by considering a given compound as built up from a base group (such as one of those listed in



**TABLE 22.1. Base-Group Properties**

Base Group	$\Delta_f H_{m,298.15K}^\circ$	$S_{m,298.15K}^\circ$	Heat Capacity Constants		
			<i>a</i>	<i>b</i>	<i>c</i>
Methane	-74.85	186.19	16.69	65.61	-9.96
Cyclopentane	-77.24	292.88	-41.92	473.71	-182.59
Cyclohexane	-123.14	298.24	-52.22	599.78	-230.91
Benzene	82.93	269.20	-22.51	402.54	-171.42
Naphthalene	150.96	335.64	-28.41	623.25	-268.91

Table 22.1), which has been modified by appropriate substitutions to yield the desired molecule. Thus, aliphatic hydrocarbons can be built up from methane by repeated substitutions of methyl groups for hydrogen atoms. Other compounds are formed by substitution of functional groups for  $CH_n$  groups. The heat capacity constants are those for a cubic polynomial in the temperature, which are similar to those discussed in Chapter 4.

In the method of Cohen and Benson [2], a group is defined as a polyvalent atom of ligancy  $\geq 2$  together with all of its ligands. Cohen and Benson tabulates thermodynamic values for 37 hydrocarbon groups, 61 oxygen-containing groups, 59 nitrogen-containing groups, 46 halogen-containing groups, 53 sulfur-containing groups, 57 organometallic groups, and 65 organophosphorus and organoboron groups.

Whatever the method for dividing a compound into groups, the group values for thermodynamic properties must be obtained from a database of experimental values.<sup>1</sup> Each experimental value for a compound yields a linear equation in which the experimental value is the sum of group contributions. Preferably, many more experimental values should exist, the dependent variables in the linear equations, than the total number of group values. Then, we have an overdetermined set of values of the group contributions. The best values of the group contributions are obtained by multivariable least-squares fitting of the equations to the experimental data [3].

We will consider in some detail only one of these procedures—that of Andersen, Beyer, and Watson, as modified by Yoneda [4]—to illustrate the type of approach used in these approximation methods.

### Group Contribution Method of Andersen, Beyer, Watson, and Yoneda

Like several other systems, this method is based on the assumption that a given thermodynamic property, such as entropy, of an organic substance can be resolved into

<sup>1</sup>Pedley provides group values and the experimental data from which they have been derived. J. Pedley, *Thermochemical Data and Structure of Organic Compounds—Vol. I*, TRC Data Series, CRC Press, Boca Raton, FL, 1994.

contributions from each constituent group in the molecule. With tables of such group contributions assembled from available experimental data, we can estimate the thermodynamic properties of any molecule by adding the contributions of the constituent groups.

The base groups of the Anderson–Beyer–Watson–Yoneda method are listed in Table 22.1. They are modified by appropriate substitutions to yield the desired molecule. Thus, aliphatic hydrocarbons can be built up from methane by repeated substitutions of methyl groups for hydrogen atoms. Other compounds are formed by substitution of functional groups for  $\text{CH}_n$  groups. All values in the tables are in units of  $\text{J mol}^{-1}$  or  $\text{J K}^{-1} \text{mol}^{-1}$  as appropriate. The heat capacity constants are similar to those discussed in Chapter 4 but for a quadratic polynomial in  $T/1000$ .

The thermodynamic quantities for large, complex molecules are obtained by adding the contributions of the appropriate substitution group to the value for the base group. Table 22.2 gives the contributions for the primary substitution of a  $\text{CH}_3$  group on a single carbon atom in each of the five base groups listed in Table 22.1. For the cyclic base groups—cyclopentane, benzene, and naphthalene—several carbon atoms are available for successive primary substitutions (no more than one on each carbon atom), and the magnitude of the contribution depends on the number and position of the added methyl groups as well as on the type of base ring.

A second substitution of a methyl group for a hydrogen on a single carbon atom of a base group is called a secondary substitution. These secondary replacements have to be treated in more detail because the changes in thermodynamic properties depend on the nature of the carbon atom on which the replacement is being made and on the nature of the adjacent carbon atom. For this reason, these carbon atoms are characterized by “type numbers,” as shown in Table 22.3. The thermodynamic changes associated with secondary methyl substitutions then can be tabulated as in Table 22.4. The number in Column A is the type number of the carbon atom on which the second methyl substitution is made, and that in Column B is the highest type of an adjacent carbon atom, with each number referring to the status of the carbon atom before the substitution is made.

The effect of introducing multiple bonds in a molecule is treated separately. The appropriate corrections have been assembled in Table 22.5 and require no special comments, except perhaps to emphasize the *additional* contribution that must be introduced every time a pair of conjugated double bonds is formed by any of the preceding substitutions in this table.

The changes in properties accompanying the introduction of various functional groups in place of one or two of the methyl groups on a given carbon are listed in Table 22.6. Data from Table 22.1 and Table 22.2 give the contributions for the appropriate methyl-substituted base groups. One should observe particularly that the  $=\text{O}$  structure requires replacement of two methyl groups, which must be added before they can be substituted by  $=\text{O}$ . The symbol @ preceding a functional group means that the values refer to the substitution of that group on an aromatic ring.

**TABLE 22.2. Contributions of Primary CH<sub>3</sub> Substitution Groups Replacing Hydrogen on Carbon**

Base Group	$\Delta(\Delta H_m)$	$\Delta S_m$	Heat Capacity Constants		
			$\Delta a$	$\Delta b$	$\Delta c$
<i>Methane</i>	-9.83	43.30	9.92	103.81	-43.51
<i>Cyclopentane</i>					
a) First primary substitution	-34.43	49.25	8.74	68.24	-23.18
b) Second primary substitution to form					
1,1	-26.61	17.15	-6.02	116.36	-55.56
1,2( <i>cis</i> )	-17.87	24.02	-3.64	110.46	-53.22
1,2( <i>trans</i> )	-25.02	24.69	-2.47	107.57	-52.13
1,3( <i>cis</i> )	-24.18	24.69	-2.47	107.57	-52.13
1,3( <i>trans</i> )	-21.92	24.69	-2.47	107.57	-52.13
<i>Cyclohexane</i>					
a) First primary substitution	-33.64	46.32	11.59	81.21	-39.58
b) Second primary substitution to form					
1,1	-24.23	20.46	-13.51	111.42	-41.00
1,2( <i>cis</i> )	-15.40	29.96	-7.99	100.00	-38.70
1,2( <i>trans</i> )	-23.22	26.36	-5.82	103.30	-43.22
1,3( <i>cis</i> )	-27.99	25.90	-6.32	95.14	-33.01
1,3( <i>trans</i> )	-19.79	31.67	-4.31	88.41	-32.17
1,4( <i>cis</i> )	-19.87	25.90	-4.31	88.41	-32.17
1,4( <i>trans</i> )	-27.82	20.25	-8.41	107.61	-44.02
<i>Benzene</i>					
a) First primary substitution	-35.48	47.91	5.77	64.43	-19.50
b) Second primary substitution to form					
1,2	-27.78	36.40	12.47	50.00	-11.97
1,3	-29.12	41.63	5.02	64.77	-19.62
1,4	-28.70	36.19	5.48	60.29	-16.15
1,2,3	-30.38	42.84	14.14	29.25	9.67
1,2,4	-33.47	43.60	16.40	18.62	16.23
1,3,5	-34.39	26.82	6.19	58.37	-14.73
<i>Naphthalene</i>					
a) First primary substitution to form					
1	-34.10	41.80	6.36	37.36	-32.09
2	-34.85	44.39	10.67	61.76	-20.17
b) Second primary substitution to form					
1,2	-26.40	30.29	13.05	64.77	-24.56
1,3	-27.74	35.56	5.61	79.54	-32.22
1,4	-27.32	30.08	6.07	75.06	-28.74
2,3	-26.40	30.29	13.10	64.77	-24.56

**TABLE 22.3. Type Numbers of Different Carbon Atoms**

Type Number	Nature
1	$-\text{CH}_3$
2	$>\text{CH}_2$
3	$>\text{CH}-$
4	$>\text{C}<$
9	C in aromatic ring

The addition of a functional group requires more corrections for the type (as in Table 22.3) of the carbon to which the functional group is attached. For example, a keto group,  $-\text{C}=\text{O}$ , is attached to a carbon atom of type 2, because that carbon is also attached to two atoms other than hydrogen. An aldehyde group,  $-\text{C}=\text{O}$ , however, would have a correction for a type 1 carbon. The corrections would then be two multiples and one multiple, respectively, of the entry in Table 22.7 for the substituent. The determination of type number is made after the substitution.

Also, when multiple substitutions are made on the same carbon atom, primarily by halogens, corrections must be made for the number of pairwise interactions among the atoms substituted on the same carbon atom. Thus, when three halogen atoms are substituted on a carbon atom, three pairwise interactions are possible and

**TABLE 22.4. Contribution of Secondary Methyl Substitution**

Type Number		Heat Capacity Constants				
A	B	$\Delta(\Delta H_m)$	$\Delta S_m$	$\Delta a$	$\Delta b$	$\Delta c$
1	1	-21.09	43.68	-3.68	98.16	-42.26
1	2	-20.59	38.87	1.46	81.42	-31.46
1	3	-15.36	36.61	-0.96	91.63	-38.95
1	4	-15.36	36.61	-0.96	91.63	-38.95
1	9	-19.66	45.31	1.55	88.53	-37.66
2	1	-28.74	21.46	-2.09	95.69	-41.67
2	2	-26.57	27.32	-0.63	90.67	-37.53
2	3	-22.22	27.36	-4.90	97.61	-41.63
2	4	-20.67	27.49	-1.21	92.05	-37.99
2	9	-24.35	28.07	-3.18	90.37	-36.32
3	1	-31.46	11.76	-2.76	107.70	-49.25
3	2	-28.62	17.99	-6.90	111.71	-51.67
3	3	-20.75	25.94	-6.90	111.71	-51.71
3	4	-23.68	4.56	-4.18	129.54	-66.32
3	9	-26.11	28.07	-3.18	90.37	-36.32

TABLE 22.5. Multiple Bond Contributions Replacing Single Bonds

Type of Bond or Correction	$\Delta(\Delta H_m)$	$\Delta S_m$	Heat Capacity Constants		
			$\Delta a$	$\Delta b$	$\Delta c$
1 = 1	136.98	-10.04	0.50	-32.76	3.72
1 = 2	126.15	-5.98	3.81	-50.92	16.32
1 = 3	116.90	0.71	12.80	-71.38	27.91
2 = 2( <i>cis</i> )	118.41	-6.32	-6.40	-37.57	11.30
2 = 2( <i>trans</i> )	114.43	-11.38	9.16	-67.53	26.78
2 = 3	114.64	0.59	-1.05	-54.06	21.21
3 = 3	115.90	-2.09	5.90	-95.86	57.53
1 $\equiv$ 1	311.42	-28.66	19.16	-98.74	22.97
1 $\equiv$ 2	290.79	-20.79	16.53	-117.07	40.71
2 $\equiv$ 2	274.22	-23.93	12.84	-127.03	51.67
Adjacent double bonds	41.38	-13.26	9.75	-7.78	2.13
Conjugated double bonds	-15.31	-16.99	-6.69	37.28	-27.49
Double bond conjugated with aromatic ring	-7.20	-9.50	5.36	-9.08	5.19
Triple bond conjugated with aromatic ring	8.8	-20.1	-3.8	4.6	0.4
Conjugated triple bonds	17.6	-20.5	3.3	14.6	-14.6
Conjugated double and triple bonds	13.8	-5.9	12.6	22.2	9.6

the entry in Table 22.7 must be multiplied by three for that case in addition to the type correction. A % symbol preceding a functional group indicates that the substituent can be added in either of two orientations and that the correct choice needs to be made.

The procedure followed in the use of the tables of Andersen et al. [1], and Yoneda [4] is illustrated below for the estimation of standard entropies. These tables also include columns of base structure and group contributions for estimating  $\Delta_f H_{m,298.15K}^\circ$ , the standard enthalpy of formation of a compound, as well as columns for  $a$ ,  $b$ , and  $c$ , the constants in the heat capacity equations that are quadratic in the temperature. Thus it is possible to estimate  $\Delta_f G_{m,298.15K}^\circ$  by appropriate summations of group contributions to  $\Delta_f H_{m,298.15K}^\circ$  and to  $S_{m,298.15K}^\circ$ . Then, if information is required at some other temperature, the constants of the heat capacity equations can be inserted into the appropriate equations for  $\Delta G_m^\circ$  as a function of temperature and  $\Delta G_m^\circ$  can be evaluated at any desired temperature (see Equation 7.68 and the relation between  $\Delta G_m^\circ$  and  $\ln K$ ).

### Typical Examples of Estimating Entropies

The use of Tables 22.1 through 22.7 will be illustrated by two examples.

TABLE 22.6. Contributions of Functional Groups

Functional Group <sup>a</sup>	$\Delta(\Delta H_m)$	$\Delta S_m$	Heat Capacity Constants		
			$\Delta a$	$\Delta b$	$\Delta c$
<i>Oxygen</i>					
=O(aldo)	-10.13	-54.39	17.11	-214.05	84.27
=O(keto)	-29.66	-84.47	6.32	-148.49	36.65
-OH	-118.99	8.62	7.28	-65.69	24.43
@OH	-146.48	-1.26	12.01	-49.79	24.27
-O-	-85.48	-5.27	13.26	-85.31	38.58
@O-	-97.78	-15.1	18.0	-69.5	38.1
-OOH	-103.3				
-OO-	-21.84				
-COOH	-350.16	53.01	7.91	29.20	-26.65
@COOH	-337.65	51.88	-8.03	25.19	-4.56
-COO-	-305.93	54.8	-17.6	1.3	7.9
@COO-	-317.69	54.8	-17.6	1.3	7.9
@OOC-	-310.12				
-COOCO-	-469.95	116.86	-5.27	124.64	-69.25
-COO <sub>2</sub> CO-	-392.0				
HCOO-	-275.85	71.76	7.91	29.20	-26.65
-CO <sub>3</sub> -	-490.24				
<i>Fluorine</i>					
-F	-154.18	-16.61	4.23	-76.57	24.56
@F	-165.23	-18.03	6.49	-59.50	18.37
@F(ortho)	-143.26	-12.84	5.90	-78.87	32.43
-COF	-355.47	57.3	14.2	-18.0	4.6
@COF	-351.46				
<i>Chlorine</i>					
-Cl	2.05	-5.90	7.45	-64.85	14.94
@Cl	9.87	-3.97	10.71	-83.35	31.05
-COCl	-159.24	53.93	22.64	-23.56	-2.43
@COCl	-155.31				
<i>Bromine</i>					
-Br	49.54	13.10	11.13	-49.92	13.05
@Br	57.57	7.28	12.30	-70.33	28.91
-COBr	-105.73	68.6	20.9	-43.5	9.2
@COBr	-98.49				
<i>Iodine</i>					
-I	101.13	14.56	11.38	-72.51	18.28
@I	115.10	8.8	12.6	-92.9	34.3
-COI	-38.03	88.3	23.4	-33.1	9.6
@COI	-31.0				

(Continued)

TABLE 22.6. *Continued*

Functional Group <sup>a</sup>	$\Delta(\Delta H_m)$	$\Delta S_m$	Heat Capacity Constants		
			$\Delta a$	$\Delta b$	$\Delta c$
<i>Sulfur</i>					
–SH	60.33	24.06	14.39	–65.94	28.41
@SH	64.10	19.75	12.13	–42.43	19.41
–S–	69.62	21.63	17.11	–83.60	46.02
@S–	70.96	17.2	15.1	–60.2	36.8
–SS–	79.83	63.47	35.61	–58.41	20.42
–SO–	–43.14				
@SO–	–39.7				
–SO <sub>2</sub> –	–279.91				
@SO <sub>2</sub> –	–276.48				
–SO <sub>3</sub> H	–1182.8				
–OSO <sub>2</sub> –	–379.53				
–OSO <sub>3</sub> –	–583.17				
<i>Nitrogen</i>					
–NH <sub>2</sub>	61.46	13.10	7.49	–37.66	13.18
@NH <sub>2</sub>	39.41	2.05	8.83	–14.39	4.39
–NH–	86.94	–0.21	1.38	–24.60	7.74
@NH–	57.57	–11.3	2.5	–1.3	–0.8
=N<	110.67	–5.86	0.04	–18.58	4.39
@N<	80.67	–16.7	1.3	4.6	–4.2
=N=(keto)	187.0				
–N=N–	266.1				
–NHNH <sub>2</sub>	170.04	49.20			
@NHNH <sub>2</sub>	153.51				
–N(NH <sub>2</sub> )–	187.74	31.51			
@N(NH <sub>2</sub> )–	171.1				
–NHNH–	195.73	39.08			
@NHNH–	179.1				
–CN	172.55	6.69	14.31	–53.39	14.69
@CN	171.38	3.93	17.78	–47.57	20.17
–NC	234.89	17.3	17.6	–47.7	20.1
=NOH	92.0				
–CONH <sub>2</sub>	–153.64	77.4	15.1	23.8	–12.6
@CONH <sub>2</sub>	–141.13				
–CONH–	–128.0				
@NHCO–	–158.3				
–CON<	87.86				
–NO <sub>2</sub>	11.51	45.52	4.77	4.64	–14.56
@NO <sub>2</sub>	17.99	45.6	4.6	4.6	–14.6
–ONO	20.67	54.81	10.33	6.32	–16.07
–ONO <sub>2</sub>	–36.69	72.38	17.24	31.84	–29.12
–NCS	234.3	61.5			

<sup>a</sup>The symbol @ preceding a functional group means that the values refer to the substitution of that group on an aromatic ring.

**TABLE 22.7. Corrections for Type Number and Multiple Substitutions of Functional Groups**

Functional Group <sup>a</sup>	$\Delta(\Delta H_m)$	$\Delta S_m$	Heat Capacity Constants		
			$\Delta a$	$\Delta b$	$\Delta c$
<i>Oxygen</i>					
=O(aldo)	-22.68	18.83	-3.60	6.74	-4.81
=O(keto)	-13.81	30.92	6.65	-47.28	34.35
-OH	-11.09	0.84	0.42	0.00	-0.42
-O-	-9.54	-2.30	2.13	-5.02	3.31
@O-	-11.76	-2.5	2.1	-5.0	3.3
-OOH	8.4				
-OO-	-10.46				
-COOH	6.44	35.90	0.0	0.0	0.0
%COO-	-11.72	-2.5	2.1	-5.0	3.3
@COO-	7.49	-2.5	2.1	-5.0	3.3
-COOCO-	-5.06	36.0	0.0	0.0	0.0
-COO <sub>2</sub> CO-	-21.3				
HCOO-	33.43	-2.5	2.1	-5.0	3.3
-CO <sub>3</sub> -	-1.21				
<i>Fluorine</i>					
-F	-6.15	4.14	1.59	-0.54	1.59
-F,-F	-15.36	-3.81	-2.01	-0.75	-1.76
-F,-Cl	11.00	-0.67	7.20	13.97	18.33
-F,-Br	17.53	6.82	4.14	-16.78	4.39
-F,-I	17.24	-0.38	7.03	-6.49	4.23
-COF	1.7				
<i>Chlorine</i>					
-Cl	-2.59	5.19	3.77	-12.55	8.03
-Cl,-Cl	17.78	-6.23	-2.59	6.49	-3.77
-Cl,-Br	21.51	6.19	7.24	-29.08	12.64
-Cl,-I	20.5	5.2	7.03	-27.57	18.91
-COCl	1.88				
<i>Bromine</i>					
-Br	-7.24	-5.23	1.63	-26.57	9.67
-Br,-Br	17.61	9.92	4.69	-35.94	19.66
-Br,-I	20.5	7.95	-1.59	-32.38	16.07
-COBr	1.7				
<i>Iodine</i>					
-I	-4.31	3.93	2.76	-10.13	7.28
-I,-I	23.39	-3.05	0.50	0.75	-1.51
-COI	1.7				

(Continued)



TABLE 22.7. *Continued*

Functional Group <sup>a</sup>	$\Delta(\Delta H_m)$	$\Delta S_m$	Heat Capacity Constants		
			$\Delta a$	$\Delta b$	$\Delta c$
<i>Sulfur</i>					
–SH	–1.13	1.59	1.46	–1.21	–1.59
–S–	–3.56	–0.17	–0.17	4.52	–3.77
@S–	–1.17	–0.4	–0.4	4.6	–3.8
–SS–	–3.43	0.08	–1.76	11.13	–9.58
–SO–	–8.24				
@SO–	–8.4				
–SO <sub>2</sub> –	–1.13				
@SO <sub>2</sub> –	25.86				
–SO <sub>3</sub> H	–11.7				
–OSO <sub>3</sub> –	–10.75				
<i>Nitrogen</i>					
–NH <sub>2</sub>	–5.44	–1.42	0.67	1.97	–2.55
–NH–	–9.75	–1.3	0.8	2.1	–2.5
@NH–	–8.70	–1.3	0.8	2.1	–2.5
–N<	–7.11	–1.3	0.8	2.1	–2.5
@N<	–4.2	–1.3	0.8	2.1	–2.5
% = N–	0.8				
%–N =	–3.8				
–N = N–	–3.8				
–NHNH <sub>2</sub>	–5.4	–1.3			
–N(NH <sub>2</sub> )–	–5.4	–1.3			
@N(NH <sub>2</sub> )–	–5.4				
–NHNH–	–5.4	–1.3			
@NHNH–	–5.4	0.0			
–CN	–12.9	2.3	4.3	–20.4	18.7
–NC	–13.0	2.5	4.2	–20.5	18.8
=NOH	0.8				
–CONH <sub>2</sub>	0.13	36.0	0.0	0.0	0.0
%–CONH <sub>2</sub> –	–5.0				
%–NHCO–	–9.6				
@NHCO–	–5.0				
–NO <sub>2</sub>	–9.46	0.0	0.0	0.0	0.0
–ONO	–26.53	0.0	0.0	0.0	0.0
–ONO <sub>2</sub>	–10.33	2.76	–1.55	3.43	–2.30
–NCS	–3.8	–1.3			

<sup>a</sup> The symbol @ preceding a functional group means that the values refer to the substitution of that group on an aromatic ring. A % symbol preceding a functional group indicates that the substituent can be added in either of two orientations and that the correct choice needs to be made.

**Example 1.** Estimate the entropy  $S_{m,298.1K}^{\circ}$  of *trans*-2-pentene(g).

	Contribution
$\begin{array}{c} \text{H} \\   \\ \text{Base group, H}-\text{C}-\text{H} \\   \\ \text{H} \end{array}$	186.3
Primary $\text{CH}_3$ substitution $\rightarrow \text{CH}_3-\text{CH}_3$	43.3
Secondary $\text{CH}_3$ substitutions $\rightarrow \text{CH}_3-\text{CH}_2-\text{CH}_2-\text{CH}_2-\text{CH}_3$	

Type numbers		
Carbon A	Carbon B	$\Delta S_{m,298.15K}^{\circ}$
1	1	43.7
1	2	38.9
1	2	38.9
Introduction of double bond at 2-position:		
2	2 <i>trans</i>	-11.4
Summation of group contributions		339.7 $\text{J K}^{-1} \text{mol}^{-1}$
Experimental value [5]		342.29 $\text{J K}^{-1} \text{mol}^{-1}$

**Example 2.** Estimate the entropy  $S_{m,298.1K}^{\circ}$  of acetaldehyde(g).

	Contribution
$\begin{array}{c} \text{H} \\   \\ \text{Base group, H}-\text{C}-\text{H} \\   \\ \text{H} \end{array}$	186.3
Primary $\text{CH}_3$ substitution $\rightarrow \text{CH}_3-\text{CH}_3$	43.3
Secondary $\text{CH}_3$ substitutions	$\begin{array}{c} \text{CH}_3 \\   \\ \text{—CH—CH}_3 \\   \\ \text{CH}_3 \end{array}$

Type numbers		
Carbon A	Carbon B	$\Delta S_{m,298.15K}^{\circ}$
1	1	43.7
2	1	21.5
Substitution of =O replacing 2 $-\text{CH}_3$ groups		
$\begin{array}{c} \text{H} \\   \\ \text{CH}_3-\text{C}=\text{O} \end{array}$		-54.4
Type correction $1 \times 4.50$		4.50
Summation of group contributions		$244.9 \text{ J K}^{-1} \text{ mol}^{-1}$
Experimental value [5]		$250.2 \text{ J K}^{-1} \text{ mol}^{-1}$

These examples illustrate the procedure used in the Andersen–Beyer–Watson–Yoneda method. The first example shows moderate agreement; the second shows poor agreement. Generally, it is preferable to consider the group substitutions in the same order as has been used in the presentation of the tables. The best agreement with experimental values, when they are known, has been obtained by using the minimum number of substitutions necessary to construct the molecule. For cases in which several alternative routes with the minimum number of substitutions are possible, the average of the different results should be used.

### Other Methods

Although the tables presented by Parks and Huffman [1] are based on older data, they are often more convenient to use, because they are simpler and because they have been worked out for the liquid and the solid states as well as for the gaseous phase. A complete survey and analysis of methods of estimating thermodynamic properties is available in Janz's monograph [5], and in the work by Reid et al. [6]. Thermodynamicists should have a general acquaintance with more than one method of estimating entropies so they can choose the best method for a particular application.

Poling et al. [6] also describe methods for estimation of additional properties, such as critical properties,  $P$ – $V$ – $T$  properties, and phase equilibria.

### Accuracy of the Approximate Methods

Free energy changes and equilibrium constants calculated from the enthalpy and entropy values estimated by the group-contribution method generally are reliable only to the order of magnitude. For example, Andersen et al. [1] have found that their estimated enthalpies and entropies usually differ from experimental values [7]

by less than  $16.7 \text{ kJ mol}^{-1}$  and  $8.4 \text{ J mol}^{-1} \text{ K}^{-1}$ , respectively. If errors of this magnitude occurred cumulatively, the free energy change would be incorrect by approximately  $19.2 \text{ kJ mol}^{-1}$  near  $25^\circ\text{C}$ . Such an error in the free energy corresponds to an uncertainty of several powers of 10 in an equilibrium constant. With few exceptions, such an error is an upper limit. Nevertheless, it must be emphasized that approximate methods of calculating these thermodynamic properties are reliable for estimating the feasibility of a projected reaction, but they are not adequate for calculating equilibrium compositions to better than the order of magnitude.

### Equilibrium in Complex Systems

The computation of chemical equilibria in complex systems has been developed extensively [8]. The computation requires a database of the Gibbs functions of formation of all substances present in the system. The equilibrium is determined by minimizing the total Gibbs function for the system, subject to the material balance constraints for all elements in the system, using the thermodynamic database for the compounds present. With the development of the Internet, several web pages provide fee-based software for carrying out the minimization for complex systems [9]. Geological systems are treated on the Java MELTS web page [10].

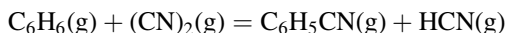
### EXERCISES

- 22.1. a.** Estimate  $S_{m,298.15\text{K}}^\circ$  for *n*-heptane (gas) by the group-contribution method of Andersen, Beyer, Watson, and Yoneda. Compare with the result obtainable from the information in Exercise 12.15.
- b.** Estimate  $S_{m,298.15\text{K}}^\circ$  for liquid *n*-heptane from the rules of Parks and Huffman. Compare with the result obtained in (a).
- 22.2. a.** Using the group-contribution method of Andersen, Beyer, Watson, and Yoneda, estimate  $S_{m,298.15\text{K}}^\circ$  for 1,2-dibromoethane(g).
- b.** Calculate the entropy change when gaseous 1,2-dibromoethane is expanded from 1 atm to its vapor pressure in equilibrium with the liquid phase at 298.15 K. Neglect any deviations of the gas from ideal behavior. Appropriate data for vapor pressures have been assembled conveniently by Boublík et al. [11], or in the NIST Chemistry Webbook [12].
- c.** Using the data given by Boublík et al. [11], or in the NIST Chemistry Webbook [12], calculate the enthalpy of vaporization of 1,2-dibromoethane at 298.15 K.
- d.** Calculate the entropy  $S_{m,298.15\text{K}}^\circ$  for liquid 1,2-dibromoethane.
- e.** Compare the estimate obtained in (d) with that obtainable from the rules of Parks and Huffman [1].
- f.** Compare the estimates of (d) and (e) with the value found by Pitzer [13].

**TABLE 22.8. Thermodynamic Data for Butadiene and Cyanogen**

Substance	$\Delta_f H_m^\circ / \text{J mol}^{-1}$	$S_m^\circ / \text{J mol}^{-1} \text{K}^{-1}$
Butadiene(g)	111,914	277.90
Cyanogen(g)	300,495	241.17

- 22.3.** Precision measurements of enthalpies of formation and entropies are probably accurate to perhaps  $250 \text{ J mol}^{-1}$  and  $0.8 \text{ J mol}^{-1} \text{ K}^{-1}$ , respectively. Show that either one of these uncertainties corresponds to a change of 10% in an equilibrium constant at  $25^\circ\text{C}$ .
- 22.4.** It has been suggested [14] that 1,4-dicyano-2-butene might be prepared in the vapor phase from the reaction of cyanogen with butadiene.
- Estimate  $\Delta_f H_m^\circ$  and  $S_m^\circ$  for dicyanobutene at  $25^\circ\text{C}$  by the group-contribution method.
  - With the aid of Table 22.8, calculate the equilibrium constant for the suggested reaction.
- 22.5. a.** Estimate  $\Delta_f H_m^\circ$  and  $S_m^\circ$  for benzonitrile,  $\text{C}_6\text{H}_5\text{CN}(\text{g})$ , at  $750^\circ\text{C}$  by the group-contribution method using benzene as the base compound.
- b.** Combining the result of (a) with published tables, estimate  $\Delta G_m^\circ$  at  $750^\circ\text{C}$  for the reaction



An estimate of  $-77.0 \text{ kJ mol}^{-1}$  has been reported by Janz [15].

## REFERENCES

- G. S. Parks and H. M. Huffman, *The Free Energies of Some Organic Compounds*, Reinhold, New York, 1932; J. W. Andersen, G. H. Beyer, and K. M. Watson, *Natl. Petrol. News, Tech. Sec.* **36**, R476 (1944); D. W. Van Krevelen and H. A. G. Chermin, *Chem. Eng. Sci.* **1**, 66 (1951); S. W. Benson, *Thermochemical Kinetics*, 2nd ed., John Wiley, New York, 1967; S. W. Benson and N. Cohen, in *Computational Thermochemistry*, K. K. Ikura and D. J. Frurip eds., American Chemical Society, Washington, DC, 1998, Chapter 2.
- N. Cohen and S. W. Benson, in S. Patai and Z. Rappoport, eds. *The Chemistry of Alkanes and Cycloalkanes*, John Wiley & Sons, New York, 1992.
- D. W. Rogers, *Computational Chemistry for the PC*, VCH Publishers, New York, 1994, Chapter 6.
- Y. Yoneda, *Bull. Chem. Soc. Japan* **52**, 1297 (1979). Reprinted with permission of the Chemical Society of Japan.
- G. J. Janz, *Estimation of Thermodynamic Properties of Organic Compounds*, rev. ed., Academic Press, New York, 1967.

6. B. E. Poling, J. M. Prausnitz, and J. P. O'Connell, *The Properties of Gases and Liquids*, McGraw-Hill, New York, 2001.
7. D. D. Wagman et al., The NBS tables of chemical thermodynamic properties, *J. Phys. Chem. Ref. Data* **11**, Supplement 2 (1982).
8. F. Van Zeggeren and S. H. Storey, *The Computation of Chemical Equilibria*, Cambridge University Press, Cambridge, UK, 1970; W. R. Smith and R. W. Missen, *Chemical Reaction Equilibrium Analysis: Theory and Algorithms*, Wiley-Interscience, New York, 1982; W. J. Lyman, W. F. Reehl, and D. H. Rosenblatt, eds., *Handbook of Chemical Property Estimation Methods*, McGraw-Hill, New York, 1982; C. M. Wal and S. G. Hutchison, *J. Chem. Educ.* **66**, 546 (1989); F. G. Heflerich, *Chemical Engineering Education*, 1989.
9. Thermo Calc, [http://www.thermocalc.com/Products/Databases/TC\\_databas.html](http://www.thermocalc.com/Products/Databases/TC_databas.html); Chemsage, <http://gttserv.lth.rwth-aachen.de/cg/Software/IndexFrame.htm>; FACT, <http://gttserv.lth.rwth-aachen.de/~cg/Data/FACT/IndexFrame.htm>.
10. <http://melts.ofm-research.org/applet.html>.
11. T. Boublík, V. Fried, and E. Hála, *The Vapor Pressures of Pure Substances*, Elsevier, Amsterdam, The Netherlands, 1973.
12. NIST Chemistry Web Book. <http://webbook.nist.gov/chemistry/>.
13. K. S. Pitzer, *J. Am. Chem. Soc.* **62**, 331 (1940).
14. G. J. Janz, *Can. J. Res.* **25B**, 331 (1947).
15. G. J. Janz, *J. Am. Chem. Soc.* **74**, 4529 (1952).



### CONCLUDING REMARKS

---

We have now concluded our consideration of the theory and methods of chemical thermodynamics. Our primary objective, to establish the principles and procedures by which the thermodynamic properties associated with a given transformation can be determined, has been achieved, and we have learned how these quantities can be used to judge the feasibility of that transformation.

However, in emphasizing these aspects of the subject, we have neglected numerous broad fields in the realm of thermodynamics. Even within the areas to which we have limited ourselves, we have omitted any discussion of surface reactions [1], and we have paid only brief attention to problems of phase equilibria [2] and to electrochemical processes [3]. We also could have examined some topics of more theoretical interest, such as relativity and cosmology [4]. Similarly, we could have considered phase equilibria at high temperature and pressure [5].

Although we have indicated some applications of thermodynamics to biological systems, more extensive discussions are available [6]. The study of equilibrium involving multiple reactions in multiphase systems and the estimation of their thermodynamic properties are now easier as a result of the development of computers and appropriate algorithms [7].

The point of view adopted toward thermodynamics in this book is the classic or phenomenological one. This approach is the most general but also the least illuminating in molecular insight. The three basic principles of phenomenological thermodynamics are extracted as postulates from general experience, and no attempt is made to deduce them from equations describing the mechanical behavior of material



bodies. As it is independent of the laws governing the behavior of material bodies, classic thermodynamics cannot be used to derive any of these laws. Generally, thermodynamic reasoning leads to relationships between certain physical quantities, but classic thermodynamics does not allow us to calculate a priori actual values of any of the quantities appearing in these relationships.

The phenomenological approach was inaugurated a century and a half ago and reached its fruition in theoretical formulation near the end of the nineteenth century. Since then, the major extension has been toward an analysis of nonequilibrium, nonisothermal processes. With the aid of additional phenomenological postulates, such as linear relationships between certain rates and appropriate forces, plus the Onsager reciprocity relationships, a conceptual system has been developed that is capable of analyzing a broad class of irreversible processes [8]. The laws of classic thermodynamics also have been recast in the form of a Euclidean metric geometry whereby its formulas can be read from simple diagrams. It has been suggested that the relationship between the geometric representation of thermodynamics and the differential equations of Gibbs is analogous to the relationship between the matrix mechanics of Heisenberg and the wave mechanics of Schrodinger [9].

Parallel with the phenomenological development, an alternative point of view has developed toward thermodynamics, a statistical–mechanical approach. Its philosophy is more axiomatic and deductive than phenomenological. The kinetic theory of gases naturally led to attempts to derive equations describing the behavior of matter in bulk from the laws of mechanics (first classic, then quantum) applied to molecular particles. As the number of molecules is so great, a detailed treatment of the mechanical problem presents insurmountable mathematical difficulties, and statistical methods are used to derive average properties of the assembly of molecules and of the system as a whole.

In the field of thermodynamics, statistical mechanics has provided a molecular model, which leads to a more concrete visualization of some of the abstract concepts (such as entropy) of classic thermodynamics. In addition, it has developed means for the analysis of microscopic fluctuation phenomena, such as Brownian motion and the density fluctuations that are the basis of light scattering. Furthermore, it has extended the range of thermodynamic reasoning to new kinds of experimental data such as spectroscopic properties of matter, and it has been fundamental to the building of a bridge between the thermodynamics and the kinetics of chemical reactions. For these reasons, a knowledge of statistical thermodynamics is essential as a companion to phenomenological thermodynamics for the effective solution of many current problems and for the formulation of stimulating new questions [10].

In principle, quantum mechanics permits the calculation of molecular energies and therefore thermodynamic properties. In practice, analytic solutions of the equations of wave mechanics are not generally accessible, especially for molecules with many atoms. However, with the advances in computer technology and programming, and the development of new computational methods, it is becoming feasible to calculate energies of molecules by *ab initio* quantum mechanics [11]. Furthermore, molecular modeling with substantial complexity and molecular mechanics treatments for

finding the minimum potential energy configurations of molecules are increasingly successful in predicting a range of thermodynamic properties for large molecules with complex structures [12]. Clearly, these procedures will occupy a dominant position as we enter the twenty-first century.

Scientists are frequently tempted or encouraged to predict what new discoveries will appear in the coming decades or century. Past attempts of this kind have proved almost invariably disappointing. For example, the reader might look back at the prediction of August Comte quoted in the preface of this edition in the light of the current status of theoretical energetics. It behooves us to recall the famous epigram (attributed to Niels Bohr):

Prediction is very difficult—especially of the future.

## REFERENCES

1. G. D. Halsey and C. M. Greenlief, *Ann. Rev. Phys. Chem.* **21**, 129 (1970); A. W. Adamson and A. P. Gast, *Physical Chemistry of Surfaces*, 6th ed., Wiley, New York, 1997; J. Toth, *Surfactant Sci. Series* **107**, 1–103 (2002).
2. A. Reisman, *Phase Equilibria, Basic Principles, Applications, and Experimental Techniques*, Academic Press, New York, 1970; H. E. Stanley, *Introduction to Phase Transitions and Critical Phenomena*, Oxford University Press, New York, 1971; J. R. Cunningham and D. K. Jones, eds., *Experimental Results for Phase Equilibria and Pure Component Properties*, American Institute of Chemical Engineers, New York, 1991; S. Malanowski, *Modelling Phase Equilibria: Thermodynamic Background and Practical Tools*, Wiley, New York, 1992; J. M. Prausnitz, R. N. Lichtenthaler, and E. G. de Azevedo, *Molecular Thermodynamics of Fluid-Phase Equilibria*, Prentice-Hall, Upper Saddle River, NJ, 1999.
3. J. Koryta, *Principles of Electrochemistry*, Wiley, New York, 1987; J. Goodisman, *Electrochemistry: Theoretical Foundations, Quantum and Statistical Mechanics, Thermodynamics, the Solid State*, Wiley, New York, 1987; G. Battistuzzi, M. Bellei, and M. Sola, *J. Biol. Inorganic Chem.* **11**, 586–592 (2006); R. Heyrovska, *Electroanalysis*, **18**, 351–361 (2006); G. Battistuzzi, M. Borsari, G. W. Kanters, E. de Waal, A. Leonardi, and M. Sola, *Biochemistry* **41**, 14293–14298 (2002).
4. B. Gal-Or, ed., *Modern Developments in Thermodynamics*, Wiley, New York, 1974; R. C. Tolman, *Relativity, Thermodynamics, and Cosmology*, Clarendon Press, Oxford, 1958; H. R. Brown, *European Journal of Physics*, **26**, S85–S90 (2005); G. Margaritondo, *European Journal of Physics*, **24**, 15–19 (2003); R. E. Criss and A. M. Hofmeister, *Geochim. Cosmochim. Acta*, **65** (2001).
5. O. Kubaschewski, P. J. Spencer, and W. A. Dench, in *Chemical Thermodynamics*, Vol. 1, The Chemical Society, London, 1973, p. 317; C. L. Young, in *Chemical Thermodynamics*, Vol. 2, The Chemical Society, London, 1978, p. 71; R. Jeanloz, *Ann. Rev. Phys. Chem.* **40**, 237 (1989); M. Th. Cohen-Adad, *Pure and Applied Chem.* **73**, 771–783 (2001); V. M. Valyashko, in *Aqueous Systems at Elevated Temperatures and Pressures*, D. A. Palmer, R. Fernandez-Prini, and A. H. Harvey, eds., Elsevier, London, 2004, pp. 597–641; R. Boehler, *Rev. Geophys.* **38**, 221–245 (2000).

6. J. T. Edsall and H. Gutfreund, *Biothermodynamics*, John Wiley and Sons, New York, 1983; I. M. Klotz, *Introduction to Biomolecular Energetics*, Academic Press, New York, 1986; J. M. Sturtevant, *Ann. Rev. Phys. Chem.* **38**, 463 (1987); I. M. Klotz, *Ligand-Receptor Energetics: A Guide for the Perplexed*, Wiley, New York, 1997; E. Shakhnovich, *Chem. Rev.* **106**, 1559–1588 (2006); M. T. Rosing, *Internat. J. Astrobiol.* **4**, 9–11 (2005); R. J. P. Williams, *Biochem. Soc. Trans.* **33**, 825–828 (2005).
7. F. Van Zeggern and S. H. Storey, *The Computation of Chemical Equilibria*, Cambridge University Press, Cambridge, UK, 1970; W. R. Smith and R. W. Missen, *Chemical Reaction Equilibrium Analysis: Theory and Algorithms*, Wiley-Interscience, New York, 1982; W. J. Lyman, W. F. Reehl, and D. H. Rosenblatt, eds., *Handbook of Chemical Property Estimation Methods*, McGraw-Hill, New York, 1982; C. M. Wal and S. G. Hutchinson, *J. Chem. Educ.* **66**, 546 (1989); F. G. Helfferich, *Chemical Engineering Education*, 1989, [Http://www.thermocalc.com/Products/Databases/TC\\_databas.html](http://www.thermocalc.com/Products/Databases/TC_databas.html), [Http://qttserv.lth.rwth-aachen.de/rcg/Software/IndexsFrame.htm](http://qttserv.lth.rwth-aachen.de/rcg/Software/IndexsFrame.htm), [Http://gttserv.lth.rwth-aachen.de/rcg/Data/Fact/IndexFrame.htm](http://gttserv.lth.rwth-aachen.de/rcg/Data/Fact/IndexFrame.htm), <http://meits.ofm-research.org/applet.html>.
8. I. Prigogine, *Introduction to Thermodynamics of Irreversible Processes*, Charles C. Thomas, Springfield, IL, 1955; A. Katchalsky and P. F. Curran, *Nonequilibrium Thermodynamics in Biophysics*, Harvard University Press, Cambridge, MA, 1965; K. G. Denbigh, *The Thermodynamics of the Steady State*, Methuen, London, 1951; H. B. Callen, *Thermodynamics and an Introduction to Thermostatistics*, 2nd ed., Wiley, New York, 1985, Chapter 14; B. C. Eu, *Kinetic Theory and Irreversible Thermodynamics*, Wiley, New York, 1992; D. Kondepudi and I. Prigogine, *Modern Thermodynamics*, Wiley, New York, 1990; Y. Demirel and S. I. Sandler, *J. Phys. Chem. B* **108**, 31–43 (2004).
9. F. Weinhold, Thermodynamics and geometry, *Physics Today*, March 1976.
10. H. L. Friedman, *A Course in Statistical Mechanics*, Prentice-Hall, Englewood Cliffs, NJ, 1985; E. A. Schrodinger, *Statistical Thermodynamics*, Cambridge University Press, Cambridge, UK, 1967; A. Msczek, *Statistical Thermodynamics*, Oxford University Press, New York, 1998.
11. L. A. Curtiss and K. Ragavachari, in *Computational Thermochemistry*, K. K. Ikura and D. J. Frurip, eds. American Chemical Society, Washington, DC, 1998, Chapter 10; L. A. Curtiss, K. Ragavachari, P. C. Redfern, G. S. Kedziora, and J. A. Pople, *J. Phys. Chem. A* **105**, 227–228 (2001), A. Kartan, E. Rabinovich, and J. M. L. Martin, *J. Chem. Phys.* **125**, 144108 (2006).
12. U. Burkert and N. L. Allinger, *Molecular Mechanics*, American Chemical Society, Washington, DC 1982; D. W. Rogers, *Computational Chemistry Using the PC*, 2nd ed., VCH Publishers, New York, 1994, Chapter 10; D. W. Rogers, in *Computational Thermochemistry*, K. K. Irikura and D. J. Frurip, eds., American Chemical Society, Washington, DC, 1998, Chapter 7; D. M. Hirst, *A Computational Approach to Chemistry*, Blackwell Scientific Publications, Oxford, UK, 1990, Chapter 3; T. P. Straatsma, *Free Energy by Molecular Simulation*, in *Reviews in Computational Chemistry*, Vol. 9, K. B. Lipkowitz and D. B. Boyd, eds., VCH Publishers, New York, 1996, p. 81; H. Meirovitch, Calculation of the free energy and the entropy of macromolecular systems by computer simulation, *Rev. in Computational Chem.* **13**, 1 (1998).

## APPENDIX A

---

# PRACTICAL MATHEMATICAL TECHNIQUES

---

Throughout our discussions we have emphasized the application of thermodynamic methods to specific problems. Successful solutions of such problems depend on a familiarity with practical analytical and graphical techniques as well as with the theoretical methods of mathematics. We consider these practical techniques at this point; references to them were made in earlier chapters for the solution of specific problems.

### A.1 ANALYTICAL METHODS

In many cases, it is possible to summarize data in terms of a convenient algebraic expression. Such an equation is desirable because it summarizes concisely a great deal of information. The data should be sufficiently precise, of course, to justify the effort of obtaining an analytical expression.

#### Linear Least Squares (1)

In the method of linear least squares, the algebraic expression to which data are fitted is linear in the least-squares parameter; the method can be used for any polynomial. We will, as an example, fit a quadratic equation to a set of experimental data such as that in Table A.1. The extension to polynomials with terms of more or fewer terms will be obvious.

---

*Chemical Thermodynamics: Basic Concepts and Methods, Seventh Edition.* By Irving M. Klotz and Robert M. Rosenberg  
Copyright © 2008 John Wiley & Sons, Inc.

**TABLE A.1. The Chemical Equilibrium of the Ammonia Synthesis Reaction at High Temperatures and Extreme Pressures<sup>a</sup>**

$\text{N}_2(\text{g}) + 3\text{H}_2(\text{g}) = 2\text{NH}_3(\text{g})$	
$P/\text{atm}$	$K_P$ at 723 K
10	0.00001452
30	0.00001490
50	0.00001505
100	0.00001616
300	0.00002480
600	0.00004238

<sup>a</sup>Reprinted from A. T. Larson and R. L. Dodge, *J. Am. Chem. Soc.* **45**, 367 (1924). Published 1924 by the American Chemical Society.

We will assume that we have a series of data, such as equilibrium constants as a function of pressure, to which we wish to fit the quadratic equation

$$y = a + bx + cx^2 \quad (\text{A.1})$$

We wish to obtain the best values of the constants  $a$ ,  $b$ , and  $c$  for an equation of this form. We should emphasize that the fitting of a set of data to a particular algebraic expression does not indicate that the expression chosen is a “good” representation for the data. A plot of the data should always be drawn to help choose an appropriate expression. In the method we will use, it is assumed that all the error lies in the dependent variable  $y$  and none in the independent variable  $x$ , although the theory also has been developed for the case in which a significant error may appear in  $x$  (1).

With the method of least squares, we obtain three independent equations to be solved for the three constants of the quadratic equation. The procedure follows from the assumption that the best expression is the one for which the sum of the squares of the residuals is a minimum. If we define the residual for the general quadratic expression as

$$r = y - (a + bx + cx^2) \quad (\text{A.2})$$

in which  $x$  and  $y$  refer to experimentally determined values, then we should obtain an equation for which

$$\Sigma r^2 = \text{a minimum} \quad (\text{A.3})$$

This condition will be satisfied when the partial derivative of  $\Sigma r^2$  with respect to each of the constants  $a$ ,  $b$ , and  $c$ , respectively, is zero. First, let us consider the partial

derivative with respect to  $a$ :

$$\Sigma r^2 = [y_1 - (a + bx_1 + cx_1^2)]^2 + [y_2 - (a + bx_2 + cx_2^2)]^2 + \dots \quad (\text{A.4})$$

$$\begin{aligned} \left(\frac{\partial}{\partial a} \Sigma r^2\right)_{b,c} &= -2(y_1 - a - bx_1 - cx_1^2) - 2(y_2 - a - bx_2 - cx_2^2) - \dots \\ &= -2(y_1 + y_2 + \dots) - 2(-na) - 2(-bx_1 - bx_2 - \dots) \\ &\quad - 2(-cx_1^2 - cx_2^2 - \dots) \end{aligned} \quad (\text{A.5})$$

Equating the right side of Equation (A.5) to zero gives

$$\Sigma y = na + b\Sigma x + c\Sigma x^2 \quad (\text{A.6})$$

By a similar procedure, we can obtain the following expression from the partial derivative of  $\Sigma r^2$  with respect to the parameter  $b$ :

$$\Sigma yx = a\Sigma x + b\Sigma x^2 + c\Sigma x^3 \quad (\text{A.7})$$

Similarly, the differentiation with respect to  $c$  leads to an expression that can be reduced to

$$\Sigma yx^2 = a\Sigma x^2 + b\Sigma x^3 + c\Sigma x^4 \quad (\text{A.8})$$

The three simultaneous equations, Equations (A.6)–(A.8), can be solved for the constants  $a$ ,  $b$ , and  $c$ .

The expressions for  $a$ ,  $b$ , and  $c$ , in terms of determinants, are

$$a = \frac{\begin{vmatrix} \Sigma y & \Sigma x & \Sigma x^2 \\ \Sigma yx & \Sigma x^2 & \Sigma x^3 \\ \Sigma yx^2 & \Sigma x^3 & \Sigma x^4 \end{vmatrix}}{\begin{vmatrix} n & \Sigma x & \Sigma x^2 \\ \Sigma x & \Sigma x^2 & \Sigma x^3 \\ \Sigma x^2 & \Sigma x^3 & \Sigma x^4 \end{vmatrix}} \quad (\text{A.9})$$

$$b = \frac{\begin{vmatrix} n & \Sigma y & \Sigma x^2 \\ \Sigma x & \Sigma yx & \Sigma x^3 \\ \Sigma x^2 & \Sigma yx^2 & \Sigma x^4 \end{vmatrix}}{\begin{vmatrix} n & \Sigma x & \Sigma x^2 \\ \Sigma x & \Sigma x^2 & \Sigma x^3 \\ \Sigma x^2 & \Sigma x^3 & \Sigma x^4 \end{vmatrix}} \quad (\text{A.10})$$

$$c = \frac{\begin{vmatrix} n & \sum x & \sum y \\ \sum x & \sum x^2 & \sum yx \\ \sum x^2 & \sum x^3 & \sum yx^2 \end{vmatrix}}{\begin{vmatrix} n & \sum x & \sum x^2 \\ \sum x & \sum x^2 & \sum x^3 \\ \sum x^2 & \sum x^3 & \sum x^4 \end{vmatrix}} \quad (\text{A.11})$$

The algebraic expressions for the coefficients  $a$ ,  $b$ , and  $c$  in terms of the summations calculated from the experimental values are

$$a = \frac{\sum y[\sum x^2 \sum x^4 - (\sum x^3)^2] + \sum x(\sum x^3 \sum yx^2 - \sum x^4 \sum yx) + \sum x^2(\sum x^3 \sum yx - \sum x^2 \sum yx^2)}{n[\sum x^2 \sum x^4 - (\sum x^3)^2] + \sum x(\sum x^3 \sum x^2 - \sum x \sum x^4) + \sum x^2[\sum x \sum x^3 - (\sum x^2)^2]}$$

$$b = \frac{n(\sum yx \sum x^4 - \sum x^3 \sum yx^2) + \sum y(\sum x^3 \sum x^2 - \sum x \sum x^4) + \sum x^2(\sum x \sum yx^2 - \sum x^2 \sum yx)}{n(\sum x^2 \sum x^4 - (\sum x^3)^2) + \sum x(\sum x^3 \sum x^2 - \sum x \sum x^4) + \sum x^2(\sum x \sum x^3 - (\sum x^2)^2)}$$

$$c = \frac{n(\sum x^2 \sum yx^2 - \sum x^3 \sum yx) + \sum x(\sum x^2 \sum yx - \sum x \sum yx^2) + \sum y[\sum x \sum x^3 - (\sum x^2)^2]}{n[\sum x^2 \sum x^4 - (\sum x^3)^2] + \sum x(\sum x^3 \sum x^2 - \sum x \sum x^4) + \sum x^2[\sum x \sum x^3 - (\sum x^2)^2]}$$

The numerical values of  $a$ ,  $b$ , and  $c$  can be found by direct substitution in the algebraic expressions if care is taken to carry an apparently excessive number of significant figures through the calculations, which involve taking small differences between large numbers. Alternatively, the determinants in Equations (A.9)–(A.11) can be evaluated by methods described in the references, or the linear equations, (A.6)–(A.8) can be solved by matrix methods (2).

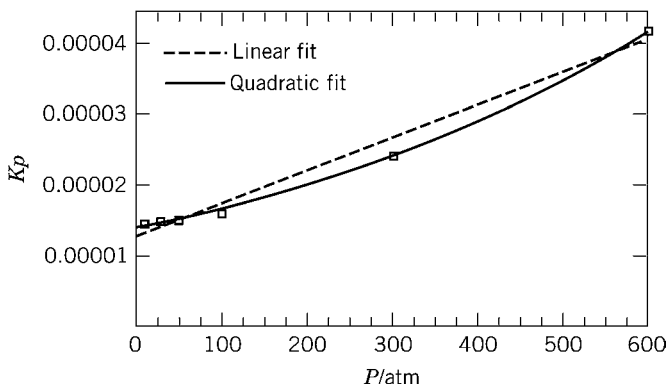
A least-squares fit to the data in Table A.1 leads to the following equation for  $K_p$  as a function of  $P$ :

$$K_p = 1.400 \times 10^{-5} + 2.267 \times 10^{-8}P + 4.121 \times 10^{-11}P^2 \quad (\text{A.12})$$

The method of least squares permits us to calculate the best function of a given form for the set of data at hand, but it does not help us decide which form of analytic function to choose. Inspection of a graph of the data is helpful in such a choice. Figure A.1 shows the data of Table A.1 as well as the best straight line and the best quadratic curve, with the latter represented by Equation (A.12), both are fitted to the data by the method of least squares.

## Nonlinear Least Squares

We shall not treat the methods of fitting nonlinear equations, those that are not linear in the parameters, in detail, but we shall remind the reader that nonlinear least squares does not lead to a closed solution for the parameters, as in linear least squares. The method of nonlinear least squares requires a set of tentative values of the parameters, followed by an iterative process that is stopped when successive results are close



**Figure A.1.** A plot of the data of Table A.1, and the best linear and quadratic curves fitted to the data by the method of linear least squares.

enough to satisfy the requirements of the user (1). Many software packages, such as PSI-PLOT, Mathcad, Sigmaplot, and Origin, or spreadsheets such as Microsoft Excel provide easy ways to carry out nonlinear least-squares fitting of complex functions. They require of the user a function to fit and tentative values of the parameters sought. The same packages also provide graphics capability, and linear least-squares fitting, along with other mathematical and statistical methods.

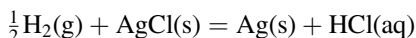
Taylor reviews the use of least-squares methods to determine the best values of the fundamental physical constants (3).

## A.2 NUMERICAL AND GRAPHICAL METHODS

Experimental data of thermodynamic importance may be represented numerically, graphically, or in terms of an analytical equation. Often these data do not fit into a simple pattern that can be transcribed into a convenient equation. Consequently, numerical and graphical techniques, particularly for differentiation and integration, are important methods of treating thermodynamic data.

### Numerical Differentiation

Let us consider a set of experimental determinations of the standard potential  $\mathcal{E}^\circ$  at a series of temperatures, such as is listed in Table A.2. A graph of these data (Figure A.2) shows that the slope varies slowly but uniformly along the entire temperature range. For thermodynamic purposes, as in the calculation of the enthalpy of reaction in the transformation



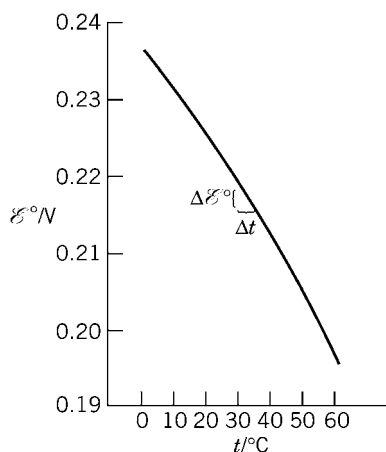


**TABLE A.2. Standard Potentials<sup>a</sup> for the Reaction**

$\frac{1}{2}\text{H}_2(\text{g}) + \text{AgCl}(\text{s}) = \text{Ag}(\text{s}) + \text{HCl}(\text{aq})$	
$t/^\circ\text{C}$	$\mathcal{E}^\circ/\text{volt}$
0	0.23634
5	0.23392
10	0.23126
15	0.22847
20	0.22551
25	0.22239
30	0.21912
35	0.21563
40	0.21200
45	0.20821
50	0.20437
55	0.20035
60	0.19620

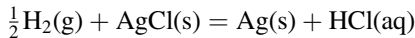
<sup>a</sup>H. S. Harned and R. W. Ehlers, *J. Am. Chem. Soc.* **55**, 2179 (1933).

it is necessary to calculate precise values of the derivative  $\partial\mathcal{E}^\circ/\partial t$ . [See Equation (7.88.)] Several procedures have been described in the literature for numerical differentiation (4), but we shall use the method described by Savitzky and Golay (5), which is designed for equally spaced values of the independent variable. Errors in the table of convoluting integers given by Savitzky and Golay are corrected by deLevie (6), and Madden has given general formulas for the computation of the convoluting integers.



**Figure A.2.** Standard cell potentials for the reaction.

This method is a simple extension of a procedure for filtering noise and smoothing data by the method of least squares, as opposed to a simple moving average. In the moving-average method, the average value of the dependent variable for an odd number of evenly spaced points is substituted for the value at the central point of the group. After dropping the first point of the group and adding the next point after the original group, the procedure is repeated until all data points have been treated. In the method of Savitzky and Golay (5), a least-squares fit to the same odd number of points is obtained, and the calculated value is substituted for the central point of the group. The process is repeated, dropping the initial point and adding the next point after the original group, until all data points have been treated. The number of points used in each group and the degree of the polynomial used in the least-squares procedure depend on the complexity of the data; we will use a five-point, quadratic polynomial fit to the data of Table A.2.



As the values of the independent variable are evenly spaced, the algebraic manipulations can be simplified by using an index number for each point as the independent variable. The residual square to be minimized is then

$$r^2 = [y - (a + bi + ci^2)]^2 \quad (\text{A.13})$$

where  $i$  varies from  $-2$  to  $+2$  in each group of five points. As the central point of the group is that for which  $i = 0$ , the calculated value of  $y$  for that point is equal to  $a$ , the calculated value of the first derivative with respect to  $i$  at the central point is equal to  $b$ , and the second derivative with respect to  $i$  at the central point is equal to  $2c$ .

In the equations for  $a$  and  $b$  following Equation (A.11), we can use  $i$  (varying from  $-2$  to  $+2$ ) for  $x$ , and  $y$  appears only to the first power; thus, the calculations lead to an expression for the least-square constants for each group of five points as a linear function of the five  $y$  values, and these functions are as follows:

$$a = \frac{(-3y_{-2} + 12y_{-1} + 17y_0 + 12y_1 - 3y_2)}{35} \quad (\text{A.14})$$

and

$$b = \frac{(-2y_{-2} - y_{-1} + y_1 + 2y_2)}{10} \quad (\text{A.15})$$

To calculate the derivative with respect to  $x$  from  $b$ , we must also divide the derivative with respect to  $i$  by the real interval in the independent variable  $\Delta x$ .

When this procedure is applied to the data in Table A.2, the results in Table A.3 are obtained. As values are obtained only for the central points of each group of points, some points are lost at each end. The procedure is clearly most useful when abscissa values are densely packed.

**TABLE A.3. Smoothed Values of the Function and First Derivative of the Data of Table A.2**

$t/^{\circ}\text{C}$	$\mathcal{E}/\text{V}$	$\mathcal{E}/\text{V}(\text{smooth})$	$(d\mathcal{E}/dt)/(\text{V}/\text{K})$
0	0.23634		
5	0.23392		
10	0.23126	0.23127	-0.000542
15	0.22847	0.22847	-0.000576
20	0.22551	0.22551	-0.000607
25	0.22239	0.22240	-0.000641
30	0.21912	0.21911	-0.000676
35	0.21563	0.21564	-0.000710
40	0.21200	0.21199	-0.000738
45	0.20821	0.20823	-0.000764
50	0.20437	0.20436	-0.000789
55	0.20035		
60	0.19620		

Many software packages, such as PSI-PLOT, Mathcad, and Sigmaplot, can carry out numerical differentiation simply and directly. Also, it is possible to fit the data to a function by the method of least squares and then differentiate. It is best to compare the results of several methods; if they agree, one has greater confidence in the results.

### Numerical Integration

The procedure for numerical integration (7) is analogous to that for differentiation. Again we will cite an example of its use in thermodynamic problems, the integration of heat capacity data. Let us consider the heat capacity data for solid *n*-heptane listed in Table A.4. A graph of these data (Fig. A.3) shows a curve for which it may not be convenient to use an analytical equation. Nevertheless, in connection with determinations of certain thermodynamic functions, it may be desirable to evaluate the integral

$$\int_{T_1}^{T_2} C_{Pm} dT$$

Therefore, a numerical method is suitable.

Once again we consider small intervals of the independent variable  $T$ , as is indicated in Figure A.3. At the midpoint of this interval, we have an average value of the heat capacity  $\bar{C}_{Pm}$ , which is indicated by the solid horizontal line in the figure. The area of the rectangular formed by the two vertical lines and the solid horizontal line between the experimental points is  $\bar{C}_{Pm}\Delta T$ . If the interval chosen is so small that the section of the curve that has been cut is practically linear, then the area below this section of the curve is essentially the same as that of the rectangle. Hence, it follows that the area under the curve between the limits  $T_1$  and  $T_2$  is

**TABLE A.4. Heat Capacities<sup>a</sup> of Solid *n*-Heptane**

<i>T</i> /K	<i>C<sub>Pm</sub></i> /J mol <sup>-1</sup> K <sup>-1</sup>	<i>T</i> /K	<i>C<sub>Pm</sub></i> /J mol <sup>-1</sup> K <sup>-1</sup>
10	1.979	100	92.772
15	6.125	110	99.161
20	11.866	120	105.286
25	18.405	130	111.156
30	25.163	140	116.922
35	31.890	150	122.784
40	38.221	160	129.131
45	44.279	170	136.394
50	50.024	180	144.499
60	60.509	182.55	146.595
70	69.848		
80	78.287		
90	86.048		

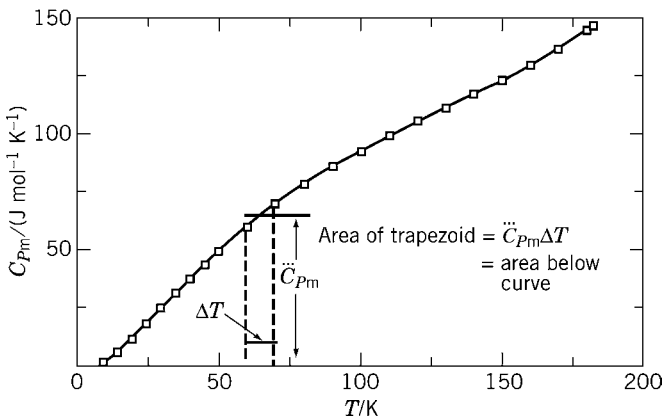
<sup>a</sup>Values calculated from data of J. P. McCullough and J. F. Messerley, *United States Bureau of Mines Bulletin 596*, 1961.

given very closely by the sum of the areas of the rectangles taken over sufficiently short temperature intervals. Because the area under the curve corresponds to the integral

$$\int_{T_1}^{T_2} C_{Pm} dT$$

it follows that

$$\sum_{T_1}^{T_2} \bar{C}_{Pm} \Delta t \cong \int_{T_1}^{T_2} C_{Pm} dt \tag{A.16}$$



**Figure A.3.** Numerical integration of heat capacity curve.

**TABLE A.5. Tabulation for Numerical Integration**

1	2	3	4	5	6
$T/K$	$C_{Pm}$	$\Delta T$	$\bar{C}_{Pm}$	$\bar{C}_{Pm}\Delta T$	$\Sigma \bar{C}_{Pm}\Delta T$
10.00	1.979				0.00
		5.00	4.052	20.260	
15.00	6.125				20.260
		5.00	8.996	44.978	
20.00	11.866				65.238
		5.00	15.136	75.678	
25.00	18.405				120.655
		5.00	21.784	108.920	
30.00	25.163				184.598

As the smoothed data in Table A.4 are given at closely successive, equally spaced temperatures, we can use these values to form the temperature intervals. For  $\bar{C}_{Pm}$  between any two temperatures, we can take the arithmetic mean between the listed experimental values. The values of  $\Delta T$  and  $\bar{C}_{Pm}$  then are tabulated as an example in columns 3 and 4 of Table A.5. Column 5 lists the area for the given interval. Finally, the sums of the areas of the intervals from 10.00 K are tabulated in column 6. The areas between any two of the temperatures listed in column 1 can be obtained by subtraction.

If we wish to obtain the value of the integral at some intermediate temperature not listed in Table A.5, we can plot the values in column 6 as a function of  $T$  and read the values of the integral at the desired upper limit, or we can use a numerical interpolation method (4).

More accurate methods of numerical integration are described in the references (5).

### Use of the Digital Computer

Both the numerical and the analytical methods discussed in this chapter can be tedious to carry out, especially with large collections of precise data. Fortunately, the modern digital computer is ideally suited to carry out the repetitive arithmetic operations that are involved. Once a program has been written for a particular computation, whether it be numerical integration or the least-squares fitting of experimental data, it is only necessary to provide a new set of data each time the computation is to be calculated.

Although the details of computer programming are beyond the scope of this text, the student unfamiliar with the subject is urged to consult one of the many books available (8). Many programs designed to carry out the calculations described in this section are available commercially for use on desktop personal computers.

Many calculations needed to produce the tables of data and results in this text can conveniently be carried out without programming with the use of a spreadsheet, several of which are available for personal computers.

**Graphical Differentiation**

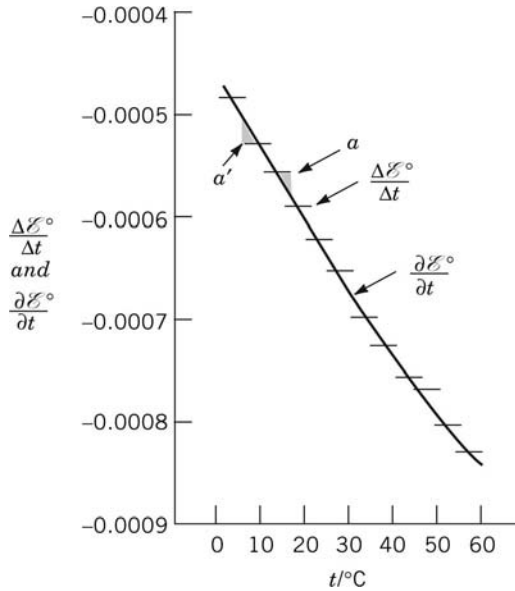
Numerous procedures have been developed for graphical differentiation. A particularly convenient one (9), which we call the chord-area method, is illustrated using the same data (from Table A.2) to which we previously applied numerical differentiation. It is clear from Figure A.2 that if we choose a sufficiently small temperature interval, then the slope at the center of that interval will be given approximately by  $\Delta\mathcal{E}/\Delta t$ . In this example, with an interval of 5°C, the approximation is good. Then we proceed to tabulate values of  $\Delta\mathcal{E}/\Delta t$  from 0°C, as illustrated in Table A.6 for the first few data. Note that values of  $\Delta\mathcal{E}^\circ$  are placed between the values of  $\mathcal{E}^\circ$  to which they refer, and the temperature intervals (5°C) are indicated between their extremities. Similarly, as  $\Delta\mathcal{E}^\circ/\Delta t$  is an average value (for example, -0.000484) within a particular region (such as 0°C to 5°C), values in the fifth column also are placed between the initial and the final temperatures to which they refer.

Having these *average* values of the slope, we now wish to determine the *specific* values at any given temperature. As  $\Delta\mathcal{E}^\circ/\Delta t$  is an average value, we draw it as a chord starting at the initial temperature of the interval and terminating at the final temperature. A graph of these chords over the entire temperature region from 0°C to 60°C is illustrated in Figure A.4. To find the slope  $\partial\mathcal{E}^\circ/\partial t$ , we draw a curve through these chords in such a manner that the sum of the areas of the triangles, such as *a*, for which the chords form the upper sides, is equal to the sum of the areas of the triangles, such as *a'*, for which the chords form the lower sides. This smooth curve gives  $\partial\mathcal{E}^\circ/\partial t$  as a function of the temperature. Some values at several temperatures are shown in column 6 of Table A.6; they agree well with those given in Table A.3, which were obtained by numerical differentiation.

In the preceding example, the chords have been taken for equal intervals, because the curve changes slope only gradually and the data are given at integral temperatures at equal intervals. Under these circumstances, the method of *numerical differentiation* is actually preferable. In many cases, however, the intervals will not be equal nor will they occur at whole numbers. For the latter cases, the chord-area method of differentiation may be necessary, although considerable care is required to avoid numerical errors in calculations.

**TABLE A.6. Tabulation for Graphical Differentiation**

1 <i>t</i> /°C	2 $\mathcal{E}^\circ$	3 $\Delta\mathcal{E}$	4 $\Delta t$	5 $\Delta\mathcal{E}^\circ/\Delta t$	6 $\partial\mathcal{E}^\circ/\partial t$
0	0.23634				
		-0.00242	5	-0.000484	-0.000476
5	0.23392				
		-0.00266	5	-0.000532	-0.000509
10	0.23126				
		-0.00279	5	-0.000558	-0.000543
15	0.22847				
		-0.00296	5	-0.000592	-0.000576
20	0.22551				
					-0.000610



**Figure A.4.** Chord-area plot of slopes of curve of Figure A.2.

One other alternative for obtaining derivatives from experimental data is to fit the data to a function by the method of least squares, either linear or nonlinear, and then to obtain the derivative analytically. We carried out both procedures for Exercise 18.4(c), and the different procedures agreed very well. Another alternative is to use a software package for numerical differentiation that does not require equal intervals in the independent variable. In any case, it is preferable to use more than one method.

### Graphical Integration

If the area under the curve in Figure A.3 needs to be determined without access to a computer, graphical integration can be used. Once the curve has been plotted, the area under the curve can be measured with a planimeter, or by cutting out the desired area, weighing the paper, and comparing the weight to that of a sample of the same paper of known area.

### EXERCISES

- A.1.** Complete the calculations in Table A.6 for the graphical differentiation of the data listed in Table A.2. Draw a graph corresponding to that of Figure A.4 but on a larger scale for more precise readings. Compare the results with those obtained by differentiation of the polynomial function that best fits the experimental data.

A.2. Complete the calculations in Table A.5 for the numerical integration of the data listed in Table A.4. Draw a graph of

$$\int_{0K}^T C_{Pm} dT$$

versus temperature. Compare the results with a numerical integration with a software package.

## REFERENCES

1. W. R. Steinbach and D. M. Cook, *Am. J. Phys.* **38**, 751–754 (1970); W. E. Wentworth, *J. Chem. Ed.* **42**, 96, 162 (1965); J. A. Irvin and T. I. Quickenden, *J. Chem. Educ.* **60**, 711–712 (1983); W. H. Press, *Numerical Recipes: The Art of Scientific Computing*, Cambridge University Press, New York, 1989; P. Gans, *Data Fitting in the Chemical Sciences*, John Wiley and Sons, Chichester, 1992; R. de Levie, *Critical Reviews in Analytical Chemistry*, **30**, 59–74 (2000); A. Cornish, *Statistical Analysis of Enzyme Kinetic Data*, in R. Eisenthal and M. J. Sanson, *Enzyme Assays*, 2nd ed., Oxford University Press, Oxford, UK, 2002, pp. 249–268.
2. B. Noble, *Numerical Methods*, Vol. I, Oliver and Boyd, Edinburgh, 1964, pp. 80–122; E. Whittaker and G. Robinson, *The Calculus of Observations*, 4th ed., Blackie and Sons, Ltd., Glasgow, Scotland, 1944, pp. 71–77; J. S. Vandergraft, *Introduction to Numerical Computations*, Academic Press, New York, 1978, pp. 162–230.
3. B. N. Taylor, *Philos. Trans. Royal Society A*, **363**, 2105–2122 (2005).
4. Whittaker and Robinson, *Calculus of Observations*, pp. 60–68; B. Noble, *Numerical Methods*, Vol. II, Oliver and Boyd, Edinburgh, Scotland, 1964, pp. 248–251; Vandergraft, *Numerical Computations*, pp. 127–137; P. Gans, *Data Fitting for the Chemical Sciences*, pp. 151–157.
5. A. Savitzky and M. J. E. Golay, *Anal. Chem.* **36**, 1627–1639 (1964); C. L. Wilkins, S. P. Perone, C. E. Klopfenstein, R. C. Williams, and D. E. Jones, *Digital Electronics and Laboratory Computer Experiments*, Plenum Press, New York, 1975, pp. 107–113; J. Steiner, Y. Termonia, and J. Deltour, *Anal. Chem.* **44**, 1906 (1972).
6. R. deLevie, *Principles of Quantitative Chemical Analysis*, McGraw-Hill, New York, 1997, pp. 652–657; H. H. Madden, *Analytical Chemistry*, **50**, 1383 (1978).
7. R. Courant, *Differential and Integral Calculus*, Vol. I, Blackie and Sons, Ltd., London, 1959, pp. 342–348; F. S. Acton, *Numerical Methods That Work*, Mathematical Association of America, Washington, DC, 1990; Whittaker and Robinson, *Calculus of Observations*, pp. 132–163; Vandergraft, *Numerical Computations*, pp. 137–161.
8. B. Wiberg, *Computer Programming for Chemists*, W. A. Benjamin, Menlo Park, CA, 1965; T. L. Isenhour and P. C. Jurs, *Introduction to Computer Programming for Chemists*, Allyn and Bacon, Boston, MA, 1972; C. L. Wilkins, C. E. Klopfenstein, T. L. Isenhour, P. C. Jurs, J. S. Evans, and R. C. Williams, *Introduction to Computer Programming for Chemists—Basic Version*, Allyn and Bacon, Boston, MA, 1974; K. Jeffrey Johnson, *Numerical Methods in Chemistry*, Dekker, New York, 1980; W. H. Press, *Numerical Recipes: The Art of Scientific Computing*, Cambridge University Press, New York, 1989.
9. T. R. Running, *Graphical Mathematics*, Wiley, New York, 1927, pp. 65–66.





# INDEX

---

- Absolute zero, thermodynamic properties at, 263–65
- Accuracy, of approximate methods, 522–23
- Acetaldehyde, estimation of entropy of, 521–22
- Acetic acid  
in a cell with a hydrogen electrode and a silver-silver chloride electrode, 473–75  
degree of dissociation of, example of activity coefficient of a weak electrolyte, 471–72  
ionization of, temperature dependence of  $\ln K$  for, 234–36
- Acetonitrile  
and benzene, properties of, 435  
and methyl-*t*-butyl ether, vapor pressure and composition, 402
- Active transport, biological, to maintain concentration gradients across a membrane, 349–50
- Activity ( $a$ )  
defined, 358  
Gibbs function and equilibrium constant in terms of, 365–67  
historic origin of the concept of, 357  
nonelectrolyte, and excess Gibbs function from experimental data, 385–406  
of strong electrolytes, determination of, 448–61
- Activity coefficient ( $\gamma$ )  
defined, 358–59  
for each ion in an electrolyte solution, 442–43  
extending data to additional temperatures with enthalpy of dilution data, 460–61  
and osmotic coefficients, table, 455  
of strong electrolytes, 439–64  
of weak electrolytes, 471–72
- Activity coefficient, mean ( $\gamma_{\pm}$ )  
calculating from a cell potential, 452–53

- Activity coefficient, mean ( $\gamma_{\pm}$ ) (*Continued*)  
 Debye–Hückel theory for  
 expressing, 463–64  
 ionic, 444–46
- Adenine, heat capacities of, 279
- Adenosine triphosphate (ATP), hydrolysis  
 of, 224–25  
 example of biologic system driving  
 endergonic reactions, 182–84
- Adiabatic expansion  
 defined, 90  
 of an ideal gas, 90–94
- Adiabatic flame temperature  
 defined, 75
- Adiabatic system  
 defined, 31  
 irreversible expansion of an ideal gas,  
 change in entropy, 135–36  
 Joule–Thomson experiment, 98–102  
 reversible change in, 131  
 work in, 37–38  
 work and heat calculations for a  
 real gas, 104
- Alloys  
 activities of components of, 393–97  
 enthalpies of formation, calculation from  
 enthalpies of solution, 74
- Alpha function, for calculating the fugacity  
 of a real gas, 240–42
- Ammonia, chemical equilibrium of the  
 synthesis of, table, 532
- Analytic methods  
 for calculating fugacity of a real gas,  
 244–47  
 for calculating the change in the Gibbs  
 function for freezing of supercooled  
 water, 203–5  
 for evaluating enthalpy of reaction,  
 variation with temperature, 69–71  
 preparation for use in  
 thermodynamics, 10–21  
 for solving thermodynamic  
 problems, 531–35
- Andersen–Beyer–Watson–Yoneda  
 method  
 estimating thermodynamic quantities  
 using, 511–12  
 group contribution method of, 512–16
- Andrews, T., on isotherms and critical  
 values, 94–96
- Antoine equation, vapor pressure  
 described by, 198
- Apparent molar enthalpy ( $\Phi H_2$ ), defined,  
 419–20
- Appearance potential, calculating bond  
 enthalpy from, 75
- Approximate method, for calculating  
 fugacity for a real gas, 246–47
- Arithmetic methods  
 for calculating the change in the Gibbs  
 function for freezing of supercooled  
 water, 202–3  
 for evaluating variation of heat of  
 reaction with temperature, 71
- Aspartate transcarbamoylase (ATCase),  
 enthalpy of the conformational  
 transition of, 54–56
- Avogadro's law, 83
- Base groups, of the Andersen–  
 Beyer–Watson–Yoneda method,  
 512–13
- Benzene, thermodynamic data for,  
 table, 297
- Benzoic acid, ionization constants of,  
 as a function of temperature,  
 table, 495
- Benzothiophene, thermodynamic data for,  
 table, 279
- Benzoylacetone, vapor pressure of, table,  
 209
- Berthelot equation, for calculating deviation  
 from ideality, 96
- Biological systems  
 Gibbs function and useful work in,  
 181–85  
 osmotic work in, 349–50  
 rates of reactions in, 5
- Biosynthetic work, exergonic reactions in  
 performing, 181–84
- Bjerrum's equation, 459
- Bloch, W., work on limiting laws for  
 colligative properties, 344n
- Body, defined, 31
- Boiling-point elevation, van't Hoff's law  
 of, 350–53
- Bond enthalpies  
 calculation of, 58–59  
 defined, 57  
 table, 59

- Born–Haber cycle, 74–75
- Boyle's law  
 derivation of heat capacity relationship from, 93n  
 ideal gas law from, 82
- Boyle temperature, defined, 106
- Bureau of Mines, data on enthalpy of solution, 56–57
- Calorimetric measurements, calculation of a standard Gibbs function from, 285–86
- Caratheodory, C.  
 formulation of the second law of thermodynamics, 154  
 use of mathematics in thermodynamics, 9
- Carbon  
 entropies and densities of, table, 207  
 graphite-to-diamond transition, thermodynamics and kinetics of, 6  
 as a one-phase system, and the geology of diamonds, 307–8
- Carbon dioxide  
 formation of, standard change in the Gibbs function for, 170–72  
 isotherms for, figure, 95
- Carbon monoxide  
 exception to perfect crystal formation, 272  
 heat of formation of, determining with Hess's law, 44
- Carbon tetrachloride, melting points of, table, 207
- Carnot, S.  
 analysis of the heat engine, 2  
 ideal heat engine of, 113
- Carnot cycle, 113–20  
 reversible, applicability to any reversible cycle, 126–27  
 temperature-entropy diagram for, 145–46
- Carnot's theorem, efficiency of a reversible Carnot engine, 118–20
- Cell potentials  
 activity from measurement of, 393–97  
 cell: AgCl, Na (amalgam), 467  
 cell: H<sub>2</sub>, HCl (*m*<sub>2</sub>), AgCl, Ag, table, 466  
 determining changes in the standard Gibbs function from, 284  
 determining equilibrium constants for dissociation of weak electrolytes from, 473–75  
 extrapolation of data by least squares to obtain a constant for calculating activities, 396  
 for indium amalgam, 404  
 measurement of, 449–53
- Centrifugal field, systems subject to, 505–9
- Change, spontaneous, predicting the direction of, 111–12. *See also* Chemical reactions
- Change of state  
 defined, 31  
 reversible, 36–37
- Characteristic temperature (8, 17), 67
- Charles's law, ideal gas law from, 82
- Chemical equilibrium, in ideal gas mixtures, 231–32
- Chemical potential ( $\mu$ )  
 of a component of an ideal gas mixture, 230–31  
 of the components of feldspar, 332  
 defined, 212–13  
 equality of, as a condition of transfer equilibrium, 305–6  
 and escaping tendency, 219–20  
 of a pure solvent, relative to solvent in solution, 345  
 relationship of fugacity to, 236  
 of a solute distributed between two immiscible solvents, 340–41  
 of a solute in a saturated solution, 328–29  
 of a solute in the one-molal standard state, 371–73  
 of a solution obeying Henry's law, 338–39  
 of a strong electrolyte, as the sum of chemical potentials of constituent ions, 441–43  
 in systems of variable composition, criteria for spontaneity and equilibrium in, 215  
 of a vapor in equilibrium with a condensed ideal solution, 320–21
- Chemical reactions  
 application of the Gibbs function to, 281–301

- Chemical reactions (*Continued*)  
 defining the number of degrees of freedom for, 306–7  
 and the Gibbs function, 170–72  
 irreversible, entropy change in, 138–39  
 spontaneous, and change in enthalpy, 47
- Chymotrypsinogen A, solubility curves in different magnesium sulfate solutions, 315–16
- Clapeyron, E., on ideal engines, 2
- Clapeyron equation  
 application to two phases in equilibrium, 194–96, 307  
 general applicability of, 201
- Clausius, R.  
 definition of entropy by, 112  
 on entropy and energy changes for spontaneous change, 148  
 mathematical formulation of the second law, 3, 113  
 statement of the second law, 112
- Clausius–Clapeyron equation, application to a two phase system, 196–98
- Closed path  
 potential energy change for, 15–16  
 reversible, entropy change in, 129–30
- Closed system, defined, 31
- Coefficients  
 $\alpha$   
 calculating for a van der Waals gas, 247–48  
 defined, 241  
 of compressibility for an ideal gas, 13–14  
 deviation, defined, 105  
 in heat capacity equations, table, 65–66  
 Joule–Thomson ( $\mu_{J,T}$ ), 100–101  
 of performance ( $\beta$ ), for a refrigerator, 117–18n  
 of thermal expansion  
 defined, 107  
 for an ideal gas, 13–14  
*See also* Temperature coefficient
- Cohen and Benson method for estimating thermodynamic quantities, 512
- Colligative properties, defined, 449
- Composition  
 partial molal quantities calculated  
 from  $J$  as a function of, 407–20  
 and vapor pressure, for solutions of methyl-*t*-butyl ether and acetonitrile, 402
- Compressibility factor ( $Z$ )  
 defined, 94  
 for representing the behavior of pure gases, 242–44
- Compression of an ideal gas, work performed and heat exchanged in, 89
- Condensed phase of an ideal solution, dependence of fugacities on mole fractions of components of, 320–21
- Conductance measurements for estimating dissociation constants of weak electrolytes, 475–80
- Conformational transitions  
 change in standard Gibbs functions for, 294  
 enthalpy of, from indirect calorimetric measurements, 54–56
- Conservation  
 of caloric, 1–2  
 of energy, line integral as a statement of, 39  
 of heat plus work, historic perspective, 3
- Constraints among the variables at transfer equilibrium, 305–6
- Conversion factors, 13–15  
 defined, 10  
 and fundamental constants, table, 12
- Corresponding states of gases, 242–44
- Critical constants, for real gases, 96–98
- Critical solution curve, defined, 378
- Critical state, defined, 94
- Cycles  
 Carnot  
 forward, 114–16  
 reverse, 116–17  
 thermodynamic, aspartate transcarbamoylase example, 55
- Cyclic path. *See* Closed path
- Cyclohexane, equilibrium data for chair to boat conversion, table, 294
- Cyclopropane, entropy at the boiling point, 269–70

- Cytochrome *c* and cytochrome *f*, example of determining standard Gibbs function from cell potentials, 284
- Dalton's law, for defining an ideal gas mixture, 228
- Debye equation, for heat capacities of solids, 67  
at low temperatures, 266
- Debye–Hückel equation  
for expressing activity coefficients for strong electrolytes, 463–64  
values of constants in, for activity coefficients in aqueous solutions, table, 463–64
- Degree, of an homogeneous function, defined, 18–19
- Degrees of freedom  
defined, 303  
number of, for describing a system, 306  
for a two-component system, 309–10
- Density, and partial volumes of ethanol-water mixtures, 411
- Dieterici equation of state, defined, 105
- Differentiation  
graphical methods for, chord-area method, 541–42  
numerical methods for, 535–38
- Differentiation of energy, entropy as an index of the state of, 147n–48
- Digital computer, for repetitive calculations, 540
- Dimethyl sulfoxide, water, equilibrium pressure and liquid composition, table, 403
- Diopside–anorthite two-component system, reduced phase diagram for, 331
- Efficiency ( $\epsilon$ )  
of a heat engine  
defined, 116  
and temperature scales, 124–25  
of a reversible Carnot engine, and the thermodynamic temperature of heat reservoirs, 122
- Electrical work, from chemical transformations, 179–80
- Electrochemical cell, temperature-dependence of the potential of, 180–81
- Electrolytes  
mixed, mean molality of a solution of, 446–48  
strong, activity coefficients of, 462–64  
uni-univalent, limiting law for, 440–43
- Electromotive force, of a lead amalgam cell, table, 393–97
- Electron transfer chain, calculation of the standard Gibbs function change in cytochrome *c* and *f*, 284
- Empirical methods, for estimating thermodynamic quantities, 511–23
- Endergonic reactions, defined, 181
- Energetics, defined, 3–4
- Energy ( $U$ )  
defined, 38  
and the first law, 37–38  
natural independent variables of, 142–43  
and work, adiabatic expansion of an ideal gas, 90–92
- Enthalpy ( $H$ )  
changes in, defined, 45  
defined, 44–45  
excess, 426–27  
on mixing two pure substances, 374  
as a function of temperature, ideal gases, 83  
Joule–Thomson, 239  
partial molar, 413–14  
analytic methods for calculating, 423  
calculating by numerical integration, 421  
of reactions, 47–52  
of a solute in the one-molal standard state, 371–73  
standard, calculation of a standard Gibbs function from, 287–90  
standard partial molar, 368–69  
of a van der Waals gas, 248–49
- Enthalpy change  
on adiabatic expansion of an ideal gas, 91–92  
at constant pressure, relationship with heat, 178–79

- Enthalpy change (*Continued*)  
 on irreversible isothermal expansion of  
 an ideal gas, 87  
 from mixing components to form an ideal  
 solution, 323, 326–27  
 molar, for the transition from solid solute  
 to supercooled liquid solute, 330  
 on reversible isothermal expansion of a  
 real gas, 104  
 on solution of naphthalene in benzene,  
 327–28  
 on transferring a component from one  
 ideal solution to another, 324
- Enthalpy increment function, for selected  
 compounds, tables, 287–89
- Enthalpy of combustion, enthalpy of  
 formation from, 53
- Enthalpy of dilution  
 calculation of relative partial molar  
 enthalpy from, 417–20  
 data for extending activity coefficient  
 data to additional temperatures,  
 460–61
- Enthalpy of formation, defined, 48–52
- Enthalpy of mixing  
 calculation of relative partial molar  
 enthalpies from, 414–17  
 and a critical solution curve, 378–81
- Enthalpy of phase transition, temperature  
 dependence of, 200–202
- Enthalpy of reaction  
 from enthalpy of formation, 52–53  
 as a function of temperature, 68–72
- Enthalpy of transition, from enthalpy of  
 combustion, 53–54
- Entropy ( $S$ )  
 at 298 K, 265–73  
 absolute, defined, 266  
 as a measure of capacity for change in a  
 system, 112  
 of aqueous ions, table, 490  
 of an aqueous solution of a salt, 488  
 calculation of, 290  
 classic definition of, 3  
 defined, 125–26  
 defined as a mathematical function, 149  
 defining the second law in terms of,  
 113–20  
 estimate of, for *trans*-2-pentene, 521  
 of gases, general equations for, 142–44  
 of ions, 487–91  
 of liquid helium below its equilibrium  
 vapor pressure, 273–74  
 of a solute in the one-molal standard  
 state, 371–73  
 standard  
 at 298.15 K, selected substances,  
 275–76  
 defined, 266  
 for nonelectrolytes, 370–73
- Entropy change  
 at constant temperature and volume, 160  
 for formation of an ideal solution from  
 pure components, 326–27  
 in irreversible flow of heat, 138  
 limit as temperature approaches zero,  
 Nernst postulate, 261  
 in mixing ideal gases  
 irreversible, 229–30  
 reversible, 228–29  
 sign of, in freezing of supercooled water,  
 205  
 for transfer of a component from one  
 ideal solution to another, 325
- Entropy of formation, of individual ions,  
 488–90
- Entropy of mixing  
 ideal, 378  
 at zero temperature, effect on statement of  
 the third law, 262
- Enzymes, effect on reaction rate in living  
 cells, 5
- Equations of state  
 defined, 31  
 Dieterici, 105  
 and ideal gas definition, 81–83  
 for ideal gases, 45–47  
 for a real gas, 94–98
- Equilibrium diagram for gypsum–  
 anhydrite equilibrium, 314
- Equilibrium  
 chemical  
 of ammonia synthesis, table, 532  
 in ideal gas mixtures, 231–32  
 in systems of variable composition,  
 221–23  
 in complex systems, 523  
 criteria for

- change in Gibbs function as,
  - 162–63
  - Planck function as, 164
  - in systems of variable composition, 213–15
- between an ideal solid solution and an ideal liquid solution, 332–33
- liquid–vapor, 198–200
- mechanical, condition for, 304
- between a pure solid and an ideal liquid solution, 327–31
- and spontaneity, in systems at constant temperature, 159–64
- tendency of systems to proceed toward, 112
- thermal, defined, 305
- transfer, for a system at constant temperature and pressure, 305–6
- two phases at, as a function of pressure and temperature, 193–94
- Equilibrium constant ( $K$ )
  - for ammonia synthesis, least squares evaluation, 534
  - calculating a standard change in the Gibbs function from, 282–83
  - and change in the Gibbs and Planck function for real gas reactions, 252
  - for dissociation of weak electrolytes, 472–80
  - for a mixture of ideal gases, 231–33
  - in terms of activity, 366–67
  - in terms of fugacity, 262
- Equilibrium pressure
  - and liquid composition for water in dimethyl sulfoxide, 403
  - of a pure condensed phase, for defining the standard state for the component in solution, 321
- Equilibrium ultracentrifugation, for establishing molecular weights of protein molecules, 508
- Equivalent conductance ( $\Lambda_e$ ), dependence on concentration, 475–76
- Escaping tendency, and chemical potential, 219–20. *See also* Fugacity
- Estimation, of entropies, 521–22
- Ethane and ethene, molar volume of liquid mixtures of, table, 433
- Ethanimine and 2,2,3-trimethylpentane, liquid–liquid equilibrium curve for, 379–81
- Ethanol–water mixtures, change in volume with change in composition, 410–13
- Euclidian metric geometry, for representing the laws of classic thermodynamics, 528
- Euler’s theorem, 18
  - for homogeneous functions, 19–21
  - of degree  $n$ , 216
- Exact differentials, 15–18
  - and change of state, 39
- Excess Gibbs functions
  - from experimental data, 385–406
  - for nonelectrolytes, 357–84
- Excess thermodynamic properties, 426–27
  - deviations from ideality in terms of, 373–76
- Exergonic reactions, defined, 181
- Expansion of ideal gases
  - adiabatic, 90–94
  - isothermal, 84–90
- Expansion of real gases, isothermal reversible, 102–4
- Experimental values
  - for activity coefficients, 462
  - methods for obtaining activity data for electrolytes, 449
- Extensive property ( $J$ )
  - defined, 10
  - in a two-component system, as a homogeneous function of degree 1 of mole numbers, 216–19
- Extent of reaction ( $\xi$ ), defined, 221
- External force, work defined in terms of, 34, 36
- Feldspar, reduced two-component phase diagram for, 310
  - interpreting quantitatively, 332
- First law, 29–41
  - complete statement of, 40
- Fluid, change of pressure with respect to sea level, 502
- Force, operational definition of, 30, 33–36



- Formation, enthalpy of  
 from enthalpy of combustion, 52  
 from enthalpy of reaction, 52–53  
 standard states and tables, 48–52
- Free energy  
 change in, relationship to the cell potential, 449–53  
 Gibbs, defined, 162  
 Helmholtz, defined, 161
- Free energy of mixing, excess, 373–74  
 as a function of composition, 374–76
- Freezing-point depression, van't Hoff's law of, 350–53
- Freezing points, measuring, for determining activities of nonelectrolytes in solution, 400–401
- Fugacity ( $f$ )  
 of components in the vapor phase of liquid–vapor or solid–vapor equilibrium, 320–21  
 of components of gaseous solutions, real gases, 249–52  
 defined, 236  
 historic origin of the concept of, 357  
 proportionality of a gas phase solute to the mole fraction in the condensed phase, 337–40  
 of a pure real gas, 236–39  
 of a real gas, calculating, 240–47
- Fugacity coefficient ( $\gamma_i$ )  
 in gaseous solutions, 251  
 for pure gases, 243–44
- Functional groups, contributions of, to thermodynamic properties, 517–18
- Fundamental constants, table, 12
- Fuoss conductance–concentration function, for relating measured conductance to ionic concentration, 480
- Gases  
 application of the first law to, 81–109  
 entropy of, 268–69  
 heat capacities of, 64–66  
 ideal, entropy of, 142–44  
 mixtures of, 227–57  
 real, entropy of, 143–44  
 standard state of, for defining activity, 359–60
- Gas phase, in equilibrium with a condensed phase at constant temperature and pressure, 196–98
- General formulation  
 for an exact differential, 16–17  
 for the first law, 38–40
- Geological equilibrium, involving water, effect of salt concentration on, 486
- Gibbs, J. Willard, 3  
 derivation of the phase rule by, 303  
 proposed fundamental thermodynamic equation for an ideal gas, 152  
 on a temperature–entropy diagram, 145
- Gibbs–Duhem equation  
 applying to Raoult's law, to infer Henry's law, 343  
 for chemical potential changes of solute and solvent in nonelectrolytes, 341–44  
 at constant temperature and pressure, defined, 217–18  
 for defining osmotic pressure, 346  
 in expressing excess free energy as a function of composition, 375  
 to relate chemical potentials of components of a solution, 397  
 to relate the osmotic coefficient of a solvent to the activity coefficient of a solute, 458–59  
 use in calculating osmotic coefficient, 455  
 use in calculating partial molar enthalpy, 415
- Gibbs function ( $G$ )  
 application to chemical changes, 281–301  
 application to phase changes, 193–210  
 changes in  
 and choice of standard states for solvents, 363  
 at constant pressure and temperature, 214  
 dependence on pressure and temperature, 172–75, 177–78  
 dependence on temperature for ionization of acetic acid, 235–36  
 and entropy change in mixing ideal gases, 228–30

- and the equilibrium constant for real gas reactions, 252
- from mixing to form an ideal solution, 325
- for processes in solution, 471–97
- and chemical reactions, 172–74
- defined, 162
- dependence on an external field, 499–502
- and the equilibrium constant, in terms of activity, 365–66
- equivalence to enthalpy at absolute zero, 263
- excess, from measurement of vapor pressure, 388–90
- increment in, 292–93
  - table, 293
- partial molar, as the chemical potential, 213
- Planck function as a temperature-normalized form of, 164
- plot against the progress variable, 221–22
- properties of, 165–70
- standard, for formation of an aqueous solute, 480–82
- in terms of activity, 365–66
- Gibbs function of formation, calculating from a Gibbs function of a reaction, 286–87
- Gibbs function of mixing, 378–81
- Gibbs–Helmholtz equation, defined, 180–81
- Glasses, entropy at 0 K, glycerol example, 262–63
- Glucose, active transport of, 350
- Glycine
  - partial molar volume in aqueous solutions, table, 424–25
  - relative molar enthalpies of, table, 432
  - thermodynamic data in aqueous solutions of, table, 492
  - transfer process example of change in the thermodynamic property  $J$ , 423–25
- Glycolamide
  - specific heats of, table, 430
  - in water, volume as a linear function of mole number, 408
- Graphical methods
  - for calculating fugacity of a real gas, 240–44
  - for differentiation
    - chord-area method, for calculation of the enthalpy, 541–42
    - to evaluate volume change of ethanol in water, 412–13
  - for integration, 542
- Gravitational field
  - dependence of the Gibbs function on, 500–501
  - exact differentials describing, example, 15–16
  - systems subject to, 499–510
- Guggenheim, E. A., 376
- Gypsum–anhydrite equilibrium, at varying pressures, change in Gibbs function for, 312–15
- Heat ( $Q$ )
  - absorption in an isothermal reversible expansion of a real gas, 103
  - at constant pressure, relationship with enthalpy change, 178–79
  - at constant pressure versus constant volume, 46
  - defined, 38
  - effects of mixing components that form an ideal solution, 322–23
  - and the first law, 38
  - flow of, irreversible, entropy change in, 136–37
  - in an irreversible isothermal expansion of an ideal gas, 87
- Heat capacity, 60–68
  - at constant pressure, 61–62
  - change in an isothermal chemical reaction, 263–64
  - and at constant volume, 62–64, 84
  - at constant volume, ideal gas, 90–92
  - data sources, 68
  - defined, 61
  - and Joule–Thomson enthalpy change, for a gas, 239
  - limiting value at constant pressure or constant volume as temperature approaches zero, 264

- Heat capacity (*Continued*)  
 at low temperatures  
   Debye equation for, 266  
   methylammonium chloride example,  
     266–68  
 and phase transitions, 201–2
- Heat engine  
 proportion of heat absorbed at the high  
 temperature converted to work, 116  
 thermodynamics arising from  
 descriptions of, 2, 113–20
- Heat exchange, reversible, with the  
 surroundings, 134–35
- Heat of formation, example of Hess's law,  
 44
- Heat of reaction, as a criterion of  
 spontaneity, approximate, 164
- Heat of vaporization, in a two phase system,  
 197–98
- Heat pump, Carnot engine as, 116–17
- Helium, validity of third law for liquid at  
 0 K, 272
- Helmholtz function ( $A$ )  
 defined, 161  
 properties of, 165–70
- Henry's law  
 application for a strong electrolyte,  
 440–43  
 for choice of standard state for a solute, to  
 define activity, 363–65  
 fugacity and, 337–40  
 as a limiting law, 346–47  
 on the molality scale, for calculating the  
 activity of a nonelectrolyte solute,  
 385–88  
 Raoult's law implying, 342–43  
 regular solutions and, 376–78  
 for a solute in a solution of  
 nonelectrolytes, and Raoult's law  
 for the solvent, 342–43
- Henry's law constants, for calculating the  
 activity of a nonelectrolyte solute,  
 391–93
- n*-Heptane  
 liquid, heat capacities of, table, 299  
 solid, heat capacities of, table, 539
- Hess's law  
 as a consequence of the first law, 45, 47  
 of constant heat summation, 43–44
- n*-Hexane, and 1,1,2-trichlorofluoroethane,  
 vapor pressures and compositions for  
 solutions of, 405
- Historic perspective, xix–xxi  
 origins of thermodynamics, 1–7
- Homogeneous functions, 18–21
- Hooke's law, reversible work for a spring's  
 changing in length, example, 37
- Hydrogen chloride, gaseous, enthalpy  
 change for solution in water, 416–17
- Hydrogen gas  
 $\alpha$  for, graph, 241  
 heat capacities as a function of  
 temperature (graph), 271  
 pressure–volume properties of, table,  
 254
- Ice  
 exception to formation of perfect crystals,  
 272  
 fusion of, change in entropy in, 132  
 irreversible phase transitions of, change  
 in entropy in, 137–38
- Ideal gases  
 application of the first law to, 81–94  
 defined, 81–83  
 entropy of, 142–43  
 estimating thermodynamic quantities for,  
 511–12  
 fundamental thermodynamic equation for  
 (Gibbs), 152  
 irreversible adiabatic expansion of,  
 change in entropy, 135–36  
 irreversible isothermal expansion of,  
 change in entropy, 133–35  
 mixtures of  
   and equilibrium, 227–36  
   as a special case of an ideal solution,  
     326–27  
 total differential equations for describing,  
 12–13
- Ideal gas temperature scale ( $T$ )  
 defined, 33  
 relationship with the thermodynamic  
 temperature scale, 122
- Ideality, deviation from  
 Berthelot equation, 96  
 for isothermal expansion of real  
 gases, 94

- Joule–Thomson effect for measuring, 98–102
- in terms of excess thermodynamic functions, 373–75
- virial function, 98
- Ideal solutions, 319–35
- formation from pure components, entropy change in, 326–27
- Index of exhaustion, entropy as, 146–50
- Indium amalgam, cell potentials for, 404
- Inert gas, effect of, on vapor pressure, 198–200
- Infinite copy model
- and activity, calculating molar free energy change, 365–66
- defined, 222
- for an ideal gas mixture, 231–32
- for ideal solution transfers, 324
- for a solution, 409–13
- Information, limitations of classic thermodynamics for obtaining, 4–6
- Integral heats of solution, example of enthalpy changes for solution of NaCl in water, 414–17
- Integral process (mixing), and change in extensive thermodynamic properties, 425–26
- Integration
- graphical methods for, 542
- numerical methods for, 538–40
- Intensive property ( $J_m$ ), partial molar variables, in a two-component system, 216–19
- Intensive variables
- defined, 10
- for defining the composition of a phase, 304
- partial molar quantities as, 216–19
- International Temperature Scale of 1990* (ITS-90), 33
- Intuitive understanding versus operational definition, 29–31
- Inversion temperature, Joule–Thomson, 101–2
- Iodine, solutions of, in water and in carbon tetrachloride, chemical potential of, 219–20
- Ionic strength
- defined, 448
- and molality, table, 448
- variation of solubility with, silver chloride example, 454
- Ionization constant, of acetic acid, 475
- extrapolation of, 479–80
- Ions, individual, entropy of formation of, 488–91. *See also* Electrolytes
- Iron silicates, solid solutions with magnesium silicates, enthalpies of solution, table, 436
- Irreversible processes
- adiabatic expansion, of an ideal gas, work done in, 94
- change of heat and work in, as a criterion of spontaneity, 111–12
- the expansion of an ideal gas, 86–87
- entropy changes in, 133–42
- Isenthalpic change, Joule–Thomson experiment, 99–100
- Isobaric temperature change, reversible, entropy change accompanying, 132
- Isochoric temperature change, reversible, change in entropy in, 133
- Isolated system, criterion for, 163
- Isopiestic method, for obtaining the activity of a solvent, 400
- Isopropyl alcohol, dissociation of, calculation of the change in the Gibbs function at 452.2 K, 281–84
- Isothermal changes
- and changes in the Gibbs, Helmholtz, and Planck functions, 165–66
- and changes in the Helmholtz functions, 175–77
- cyclic, for reversible and irreversible processes, 177
- on formation of an ideal solution, entropy change for, 326–27
- in an ideal gas, thermodynamic quantities for, table, 87–88
- on irreversible expansion of an ideal gas, 133–36
- isothermal, of an ideal gas, 84–90
- reversible, entropy change for, 130–31
- Isotherms, for real gases, 94
- Joule, J., adiabatic work experiments by, 37
- Joule cycle, defined, 153

- Joule–Thomson coefficient ( $\mu_{J,T}$ )  
 for an isenthalpic process, 100–102  
 relationship of the pressure coefficient of  
 the molar enthalpy of a gas to, 239  
 for a van der Waals gas, 249
- Joule–Thomson effect  
 measuring deviations from ideal gas  
 behavior from, 98–102  
 for a van der Waals gas, 247–49
- Kelvin, Lord William Thompson  
 formulation of the second law of  
 thermodynamics, 112  
 mathematical expression of the second  
 law, 3  
 naming of the field, 1
- Kelvin–Planck statement of the second law,  
 117–18, 176–77
- Kirkwood–Buff theory, derivation of the  
 Debye–Hückel limiting law from, 464
- Law of corresponding states, reduced  
 variables and, 96–97
- Lead amalgam, activities of components of,  
 393–97
- Least squares  
 fitting data to a polynomial using,  
 ethanol–water mixture example, 412  
 linear, for evaluating polynomial  
 expressions, 531–34  
 nonlinear, 534–35
- Lewis, G. N.  
 on escaping tendency, 219–20  
 fugacity defined by, 236, 357
- Lewis and Randall  
 rule for approximation, to calculate  
 fugacity coefficients in a gaseous  
 solution, 251  
 statement of the third law, 262–63
- L'Hopital's rule, example of use of, 263
- Limiting cases, treatment of, as a limitation  
 of thermodynamics, 6
- Limiting laws  
 expression of boiling point elevation  
 of solutions with a nonvolatile  
 solvent, 352  
 expression of freezing point depression  
 of solutions with a nonvolatile  
 solvent, 353
- Henry's law, 343  
 Raoult's law, 343  
 van't Hoff's law of osmotic pressure,  
 347–48
- Line integral, defined, 16–17
- Liquids  
 entropy calculations for, 266–68  
 heat capacities of, 68  
 standard states for, 360–65  
 supercooled, in an ideal solution, 327–28
- Macroscopic systems, descriptions of, in  
 thermodynamics and classic  
 mechanics, 4–5
- Margulies equation, for expressing different  
 degrees of nonideality for solutions,  
 376
- Massieu function ( $J$ )  
 defined, 161–62  
 natural variables of, 185
- Mathematical techniques, 531–43  
 for thermodynamics, 9–28
- Mean activity ( $a_{\pm}$ )  
 of ions of a strong electrolyte, 442  
 for unsymmetrical salts, 443–44
- Mean activity coefficient ( $\gamma_{\pm}$ ), 444–46  
 calculating from cell potential, 452–53  
 Debye–Hückel limiting law for  
 evaluating, 479–80
- Mean molality ( $m_{\pm}$ ), for multivalent  
 electrolytes, defined, 444–46
- Mechanical work, in living cells, 185
- Membrane, selectively permeable,  
 separating phases of differing  
 composition, 345–50
- Mercury, vapor pressure as a function of  
 temperature, 209
- Methylammonium chloride, entropy of as a  
 function of temperature, typical  
 calculation, 266–68
- Methyl substitution  
 contributions of, to thermodynamic  
 properties, table, 514  
 secondary, contributions to  
 thermodynamic properties, table,  
 515
- Methyl-*t*-butyl ether  
 and acetonitrile, vapor pressure and  
 composition of solutions, 402

- and chloroform
  - excess volume of solutions of, table, 434
  - vapor pressure and vapor composition of, 388–90
- Miscibility, limited, and regular solutions, 378–81
- Miscibility gap, defined, 381
- Mixing, thermodynamics of, 325–27.
  - See also* Enthalpy of mixing; Entropy of mixing
- Mobility, change in, with changes in ion concentration, 476–77
- Molality, chemical potential as a function of, in solutions of dilute nonelectrolytes, 340
- Molar entropies, comparison of calculation methods, table, 271
- Mole fraction, chemical potential as a function of, for a solute in a saturated solution, 328–29
- Multiple bond, contributions of, on replacing single bonds, table, 516
- Multiple substitutions of functional groups, corrections for, 519–20
- Multivalent electrolytes, definitions and standard states for, 443–46
- Naphthalene, solution in benzene,
  - example of a pure solid in equilibrium with and ideal liquid, 327–28
- National Institute of Standards and Technology, Thermodynamics Research Center of, 49
- Natural variables
  - for  $A$ , 168
  - for  $G$ , 167
  - for  $S$ , 142
  - for  $U$ , 142–43
  - for  $Y$ , 169
- Nernst heat theorem, 260–61
- Nernst's distribution law, for dilute solutions of nonelectrolytes, 340–41
- Newton, I., definition of time, 30
- Nitric acid, standard Gibbs function for formation of undissociated  $\text{HNO}_3$ , 485–86
- Nonelectrolytes
  - activities of
    - excess Gibbs functions and standard states for, 357–84
    - from experimental data, 385–406
    - dilute solutions of, 337–55
  - Nonreacting systems, phase rule for, 304–6
  - Number-average molar mass ( $M_n$ ), defined, 348
  - Numerical methods
    - for differentiation, standard potential example for demonstrating, 535–38
    - for evaluating the variation of heat of reaction with temperature, 71
    - for integration
      - to determine activity coefficients, 460–61
      - determining partial molar quantities of one component from those of another, 420–21
      - heat capacity data as an example of, 538–40
- Objectives, of chemical thermodynamics, 4
- One-component systems, degrees of freedom in, 307–9
- Open system, defined, 31
- Operational definition versus intuitive understanding, 30–31
- Osmotic coefficient ( $g$ )
  - defined, 458–59
  - to express deviation of solvent behavior from Raoult's law, 455–60
- Osmotic pressure ( $\Pi$ )
  - defined, 347
  - measuring, 457
  - van't Hoff's law of, 344–50
- Osmotic work, in living cells, 185
- Oxygen, pressure–volume properties of, table, 255
- Partial differentiation, 10–21
- Partial molar entropy, of solute in the standard state, 370–73
- Partial molar properties ( $J_{mi}$ )
  - analytic methods for calculation, 422–23
  - defined, 213

- Partial molar properties ( $J_{mi}$ ) (*Continued*)  
of different components, relationships  
among, 216–19  
of a single component, relationships  
among, 215–16
- Partial molar quantities, calculating from  
experimental data, 407–26
- Partial pressure  
of an ideal gas, defined, 231  
of toluene and acetic acid, table, 401
- trans*-Pentene, estimating the entropy of, 521
- Perfect crystal, defining, 272
- Perpetual-motion machines  
of the first kind and of the second  
kind, 113  
of the second kind, and the second law,  
117–18
- Pfaff equation, 9
- Phase changes  
application of the Gibbs and Planck  
function to, 193–210  
spontaneous, change in the Gibbs  
function for, 202–5  
*See also* Phase transitions
- Phase diagram, for helium, 272–73
- Phase rule, 303–17  
defined, 306
- Phases, number in a system, defined, 303
- Phase transitions  
irreversible, entropy change in, 137  
reversible, entropy change in, 131–32  
temperature dependence of enthalpy of,  
200–202
- Phenomenological approach, historic  
development of, 528
- N-(Phosphonacetyl)-L-aspartate (PALA),  
binding to aspartate  
transcarbamoylase, 54–56
- Planck, M., 3  
formulation of the third law, 261–62
- Planck function ( $Y$ )  
application to phase changes, 193–210  
change in  
at constant pressure and  
temperature, 214  
and equilibrium constant for an ideal  
gas, 234  
and equilibrium constant for  
a real gas, 252  
temperature dependence of ionization  
of acetic acid, 235  
defined, 163  
properties of, 165–70  
total differential for, 167
- Poincaé, H., summary of operational  
definitions, 30–31
- Polyvinyl acetate in methyl ethyl  
ketone, osmotic pressure data for,  
table, 354
- Power series  
for expressing degrees of nonideality  
for solutions, 375–76  
for expressing nonideality for solutions,  
coefficient B of, 378
- Pressure  
change of fugacity with, 237–38  
chemical potential as a function of, for a  
solute in a saturated solution,  
328–29  
constant  
as a condition of mechanical  
equilibrium, 304  
and constant temperature, 162–64  
and heat, 43–44  
phase diagram for a two-component  
system at, 312  
dependence of activity on, 367  
dependence of change in the Gibbs  
function on, 172  
low, fugacity at, 248  
reduced, compressibility factor as a  
function of, 242  
temperature derivatives of, 264–65  
varying, phase rule for two phases,  
312–15
- Principle of impotence, for describing  
fundamental principles in the physical  
sciences, 113
- Process, defined, 31
- Progress variable, defined, 221
- Properties, of a body, defined, 31
- Protein, conformational transition of, and  
enthalpy, 54–56
- Proton affinity, defined, 74–75
- Pure phase system, partial molar quantities  
for, 218–19
- Pure substances, standard states  
of, 360

- Raoult's law  
 for choice of standard state for a solute, 363–65  
 defining an ideal solution in terms of, 319–21  
 difference from Henry's law, 338–39  
 excess free energy of mixing of a solution following, 376  
 for solvents in nonelectrolyte solutions, and Henry's law for the solute, 341–44
- Reacting systems, phase rule for, 306–7
- Reactions, enthalpy of, from bond enthalpies, 59–60. *See also* Chemical reactions
- Real gases  
 application of the first law to, 94–104  
 entropy of, 143–44  
 mixtures of, calculating the fugacity of, 249–52  
*See also* Ideal gases
- Real solutions, activity coefficient as a measure of deviation from ideality, 361. *See also* Ideal solutions
- Reciprocity characteristic equations derived from, for the Gibbs, Helmholtz, and Planck functions, 169–70  
 for an exact differential, 17
- Redlich–Kister expression  
 for excess property determination, 426–27  
 power series for representing solutions of different degrees of ideality, 375–76
- Redlich–Kwong equation, 96–97  
 calculating fugacity of a real gas from, 244–46
- Reduced phase diagram, at constant pressure, for a two-component system, 331
- Refrigerator, Carnot engine as, 116–17
- Regular solutions  
 defined, 376  
 and Henry's law, 376–78  
 and limited miscibility, 378–81
- Relative partial molar enthalpy ( $L_{mi}$ )  
 for aqueous sodium chloride, table, 469  
 defined, 413–14  
 from enthalpies of dilution, 417–20
- Reversibility  
 Carnot's introduction of, 2  
 criterion for, and equilibrium, 159  
 of reactions in an electrical cell, 284  
 spontaneity and equilibrium, 159–64
- Reversible cycle  
 entropy changes in, 130–33  
 $S$  for any substance in, 127–29
- Reversible process, defined, 84–85
- Salt, entropy of an aqueous solution of, 486–91
- Sargent cycle, defined, 153
- Scatchard, G., 376
- Second law, 111–57  
 alternative statement of, 117–18  
 defined, Clausius, 112–13  
 mathematical statement of, condensed, 134  
 stated as change in entropy, 159
- Sedimentation equilibrium, concentration distribution of solute in solution at, graph, 508
- Selenium chloride, enthalpy of formation of, 59–60
- Serine  
 enthalpies of dilution for aqueous solutions, table, 417  
 relative partial molar enthalpy of, in water solutions, graph, 419
- Sign convention, for work, 34
- Silicon dioxide, equilibrium relationships among solid forms of, 307–8
- Silver chloride  
 solubility in water containing solvent electrolytes, table, 467  
 standard Gibbs function for formation of solid solute, 483–84
- Silver-copper system, as a two-component system with limited solubility, 310–11
- Sodium chloride, example of standard Gibbs function for formation of solid solute in aqueous solution, 482–83
- Sodium-potassium system, phase diagram at constant pressure, 312



- Solids**  
 entropy calculations for, 266–68  
 heat capacities of, 67  
 homogeneous, determining the purity of, 315–16  
 pure, equilibrium with an ideal liquid solution, 327–31  
 solubility of, to form ideal solutions, 328  
 standard states for, 360–65
- Solid solution, entropy at 0K, silver chloride, silver bromide example, 262**
- Solid-state reactions, enthalpy of, from measurement of enthalpy of solution, 56–57**
- Solubility**  
 change with pressure at a fixed temperature, 328–29  
 change with temperature, 329–31  
 of cupric iodate in aqueous solutions, table, 469  
 equilibrium, of oxygen and nitrogen, change with depth in the ocean, 504  
 limited, in a two-component system  
 silver–copper example, 310–11  
 sodium–potassium example, 312  
 measuring, 453–55
- Solute**  
 activity of, 385–87  
 calculating from activity of the solvent, 399–400  
 from distribution between two immiscible solvents, 391–93  
 dissolved, thermodynamic functions for, table, 447  
 molality of  
 limiting condition for defining activity, 358  
 thermodynamic properties in the standard state, 371  
 mole fraction, limiting condition for defining activity, 358  
 in solution, mole fraction scale and choice of a standard state, 361–65  
 standard partial molar enthalpy for, 368–69
- Solutions**  
 determination of the activity in one solvent from the activity in the other, 397–400  
 enthalpy of solid-state reaction data from, 56–57  
 of real gases, approximating the fugacity of, 251
- Solvent**  
 activity of, 385  
 calculating from the activity of the solute, 398–99  
 two immiscible, activity of a solute from distribution between, 391–93  
 limiting condition for defining activity, 358  
 in a solution, standard state for, 360–61  
 standard partial molar enthalpy for, 368
- Solvent–solute interaction, effect on the volume of the solvent and of the solute, 408**
- Special relativity, time defined in, 30–31**
- Spontaneity**  
 criteria for  
 escaping tendency, 222–23  
 Gibbs function change, 162  
 natural processes, 111–12  
 in systems of variable composition, 213–15  
 entropy change as an index of the tendency toward, 148  
 of irreversible change, 159  
 Planck function as a criterion of, 164  
 of reactions, limitation of classic thermodynamics in describing, 5  
 reversibility and equilibrium, 159–64  
 Spring, example of sign conventions for work, 34
- Standard cell potentials, variation with temperature, H<sub>2</sub> reaction with silver chloride, 535**
- Standard enthalpy, calculation of a standard Gibbs function from, 288–93**
- Standard entropy**  
 calculation of a standard Gibbs function from, 288–93  
 of the hydrogen ion, 489–90
- Standard Gibbs function**  
 calculation of change in  
 from calorimetric measurements, 285–86

- from equilibrium measurements, 281–84
  - from spectroscopic data, 290–93
- calculations from, typical, 480–87
- of formation
  - of an aqueous solute, hydrogen chloride example, 480–82
  - determining changes in the Gibbs function from, 286–87, 291–93
  - of individual ions, 482
  - of an ion of a weak electrolyte, 484–85
  - of a moderately strong electrolyte, 485–86
  - of solid solute in aqueous solution, 482–84
- Standard state
  - choice of, for defining activities, 359–65
  - for a component in an ideal solution, defined, 321
  - and enthalpy change, 47–48
  - for the Gibbs function, 170–72
  - Henry's law, 387
  - for partial molal enthalpy, infinitely dilute solutions as, 413–14
  - for a solute in a solution, 361–65
    - using molality to define activities, 364–65
  - for a ternary electrolyte, 445
  - for thermodynamic calculations, table, 372
- State function
  - energy  $U$ , 39–40
  - enthalpy  $H$ , 45, 52–57
  - entropy  $S$ , 129–30
  - Gibbs function ( $G$ ), 162
  - for a system of variable composition, 211–13
- Statistical thermodynamics
  - defined, 5
  - entropy calculations resolving an exception to the third law, 270–71
- Stoichiometric coefficients, defined, 221–23
- Strong electrolytes, 439–64
- Successive approximations
  - for determining the dissociation constant
    - for a weak electrolyte, 477–79
    - acetic acid example, 474–75
- Succinic acid, in water, Gibbs function
  - for formation of the first anion of, 484–85
- Sucrose
  - heat capacities of, 279
  - synthesis of, change in the Gibbs function in, 183–84
- Sulfur, allotropic forms in equilibrium, 206
- Surroundings of a system, defined, 31
- Symmetrical salts, definition of activity for, 443
- Systems
  - of variable composition, 211–26
  - variables needed to describe the state of, 304
- Temperature
  - change of
    - in adiabatic expansion of an ideal gas, 91–94
    - in isobaric reversible expansion, 132–33
  - change in fugacity with, 238–39
  - change of solubility with, 329–31
  - constant
    - as a condition for thermal equilibrium, 305
    - effect of an inert gas on vapor pressure, 199–200
    - equilibrium and spontaneity at, 159–91
  - dependence on
    - of activity, 368–70
    - of change in the Gibbs function, 172–75, 234
    - of change in the standard Gibbs function and  $\ln K$ , 234–36
    - of equilibrium compositions of an ideal solution, 333
    - of the equilibrium constant, in an ideal gas mixture, 232–33
  - development of a scale for, 31–33
  - efficiency of a reversible Carnot engine
    - as a function of, 120
  - enthalpy of reaction as a function of, 68–72
  - natural thermodynamic definition
    - of, 143

- Temperature (*Continued*)
- reduced, compressibility factor as a function of, 242
  - variable, at constant total pressure, effect of an inert gas on vapor pressure, 200
  - variation of heat capacity with, for gases, 64
- Temperature coefficient
- of the chemical potential, 322–23
  - of free energy with entropy or enthalpy, applied to excess functions, 374
  - of a free energy change in an electrochemical cell, 181
- Temperature derivative, of the activity, 369–70
- Temperature–entropy diagram, 144–46
- Temperature interval, for equilibrium between solid and liquid phases of an ideal solution, 332
- Temperature scale
- operational definition of, 32–33
  - thermodynamic, 120–25
  - defined, 121
- Theoretical correlation, for accounting for thermodynamic properties of aqueous solutions, 462–64
- Thermally insulated state, defined, 31
- Thermodynamic change, in adiabatic expansion of an ideal gas, table, 92
- Thermodynamic functions, for dissolved solutes, table, 447
- Thermodynamic property ( $J$ )
- changes in, on transfer or mixing in solutions, 423–26
  - defining, ideal gas example, 18
  - enthalpy, 45
  - entropy, 113, 125–30
  - Gibbs, Helmholtz, and Planck functions as, 165–70
  - of two ideal solutions with different mole fractions, same components, table, 324
- Thermodynamic quantities, estimation of, 511–25
- Thermometric property, magnitude of heat exchanged in a Carnot cycle, 121
- Third law, 259–80
- apparent exceptions to, 270–73
  - defined, Lewis and Randall statement, 262
- Time, operational and intuitive definitions of, 30–31
- Toluene, and acetic acid, partial pressures, table, 401
- Total differential
- for  $A$  as a function of  $T$  and  $V$ , 168
  - equation for, 10–13
  - Gibbs, Helmholtz and Planck functions, 166–67
- Transfer, of a component from one ideal solution to another, thermodynamics of, 323–25
- Transfer process (differential process), changes in  $J$  for, 423–25
- $\lambda$  transition, in liquid helium, 273–74
- 1,1,2-Trichlorofluoroethane, and  $n$ -hexane, vapor pressures and compositions for, 405
- Triple point
- defined, 307
  - of water, temperature at as a reference temperature, 33, 121
- Trouton's rule, 60
- Two-component systems, phase rule in, 309–16
- Two-phase systems, Carnot cycle for, water example, 156
- Type numbers
- corrections for, 519–20
  - to designate carbon atoms involved in secondary substitutions, 513, 515
- Units, SI, defined, 10–12
- Uni-univalent electrolytes, definition and standard states in solution, 440–43
- Unsymmetrical salts, definition of activity for, 443–45
- Upper critical solution temperature, defined, 379–81
- Urea, density data for aqueous solutions of, table, 432
- Valine, glycyl-L-, enthalpies of dilution for aqueous solutions of, table, 435
- van der Waals equation, 94–96
- calculating thermodynamic quantities for isothermal reversible expansion with, 103–4

- for describing deviations from ideality, 94–96
- entropy of a gas obeying, 144
- Joule–Thomson inversion temperature from, 102
- for predicting the behavior of real gases, 247–49
- van't Hoff law
  - of freezing-point depression and boiling-point elevation, 350–53
  - of osmotic pressure, 344–50
- van't Hoff mixing experiment, 228–29, 236–39
- Vapor phase, of an ideal solution,
  - Raoult's law for describing, 319–21
- Vapor pressure
  - activity from measurements of, 385–88
  - Clapeyron's equation for, 2
  - and composition, for solutions of methyl-*t*-butyl ether and acetonitrile, 402
  - effect of an inert gas on, 198–200
  - excess Gibbs function from measurements of, 388–90
  - Planck function as a criterion of, 164
- Variables
  - for expressing the phase rule, 303
  - of state, defined, 31
  - of thermodynamics, 10
- Velocity of propagation of sound ( $w$ ), in a gas, defined, 106–7
- Virial equation
  - for calculating the fugacity of a real gas, 244
  - for deviation from the ideal gas law, 98–99
- Volume
  - change in
    - on mixing of pure components to form an ideal solution, 321–22
    - for transfer of a component from one ideal solution to another, 324
  - constant, with constant temperature, 160
  - excess
    - defined, 426
    - on mixing two pure substances, 374
  - as a linear function of mole number, glycolamide in water example, 408
  - molar, change in, for transition from solid solute to supercooled liquid, 329
  - partial molar, 409–13
    - analytic methods for calculating, 422–23
    - numerical integration for calculating, 421
    - temperature derivatives of, 264–65
  - Volume–pressure isotherm, for a real and ideal gases, graph, 240
- Water
  - in dimethyl sulfoxide, equilibrium pressure and liquid composition, 403
  - in equilibrium
    - with hydrogen and oxygen, as a two-component system, 306–7
    - with its vapor, as a one-component system, 306
  - vapor pressure of, graph, 195–96
  - in ethanol solutions, calculating partial molar volume for, 412–13
  - formation of
    - enthalpy of and state of the product, 47–48
    - from gaseous hydrogen and oxygen, entropy change in, 139, 270–71
  - relative partial molar enthalpy of, in serine solutions, graph, 419
  - supercooled, change in the Gibbs function on freezing of, 202–5
  - See also* Ice
- Work ( $W$ )
  - in adiabatic expansion of an ideal gas, 90–92
  - irreversible, 94
  - capacity to perform, loss in spontaneous transformations, 146–48
  - change of  $dW_{\text{net}}$ , in spontaneous and nonspontaneous transformations, 214
  - defined, 33–37
  - net, reversible in an electrical cell, 284
  - nonmechanical, and change in enthalpy, 45
  - osmotic, in biological systems, 349–50
  - performed in mixing gases, 228–29
  - useful
    - and the Gibbs and Helmholtz functions, 175–85
    - from reversible conversion of hydrogen and chlorine to HCl, 179–80